



LUMINARY MICRO™

LM3S6916 Microcontroller

DATA SHEET

Legal Disclaimers and Trademark Information

INFORMATION IN THIS DOCUMENT IS PROVIDED IN CONNECTION WITH LUMINARY MICRO PRODUCTS. NO LICENSE, EXPRESS OR IMPLIED, BY ESTOPPEL OR OTHERWISE, TO ANY INTELLECTUAL PROPERTY RIGHTS IS GRANTED BY THIS DOCUMENT. EXCEPT AS PROVIDED IN LUMINARY MICRO'S TERMS AND CONDITIONS OF SALE FOR SUCH PRODUCTS, LUMINARY MICRO ASSUMES NO LIABILITY WHATSOEVER, AND LUMINARY MICRO DISCLAIMS ANY EXPRESS OR IMPLIED WARRANTY, RELATING TO SALE AND/OR USE OF LUMINARY MICRO'S PRODUCTS INCLUDING LIABILITY OR WARRANTIES RELATING TO FITNESS FOR A PARTICULAR PURPOSE, MERCHANTABILITY, OR INFRINGEMENT OF ANY PATENT, COPYRIGHT OR OTHER INTELLECTUAL PROPERTY RIGHT. LUMINARY MICRO'S PRODUCTS ARE NOT INTENDED FOR USE IN MEDICAL, LIFE SAVING, OR LIFE-SUSTAINING APPLICATIONS.

Luminary Micro may make changes to specifications and product descriptions at any time, without notice. Contact your local Luminary Micro sales office or your distributor to obtain the latest specifications before placing your product order.

Designers must not rely on the absence or characteristics of any features or instructions marked "reserved" or "undefined." Luminary Micro reserves these for future definition and shall have no responsibility whatsoever for conflicts or incompatibilities arising from future changes to them.

Copyright © 2007 Luminary Micro, Inc. All rights reserved. Stellaris, Luminary Micro, and the Luminary Micro logo are registered trademarks of Luminary Micro, Inc. or its subsidiaries in the United States and other countries. ARM and Thumb are registered trademarks and Cortex is a trademark of ARM Limited. Other names and brands may be claimed as the property of others.

Luminary Micro, Inc.
108 Wild Basin, Suite 350
Austin, TX 78746
Main: +1-512-279-8800
Fax: +1-512-279-8879
<http://www.luminarymicro.com>



LUMINARY MICRO™



Table of Contents

About This Document	18
Audience	18
About This Manual	18
Related Documents	18
Documentation Conventions	18
1 Architectural Overview	20
1.1 Product Features	20
1.2 Target Applications	26
1.3 High-Level Block Diagram	26
1.4 Functional Overview	27
1.4.1 ARM Cortex™-M3	28
1.4.2 Motor Control Peripherals	28
1.4.3 Analog Peripherals	29
1.4.4 Serial Communications Peripherals	29
1.4.5 System Peripherals	31
1.4.6 Memory Peripherals	31
1.4.7 Additional Features	32
1.4.8 Hardware Details	33
2 ARM Cortex-M3 Processor Core	34
2.1 Block Diagram	35
2.2 Functional Description	35
2.2.1 Serial Wire and JTAG Debug	35
2.2.2 Embedded Trace Macrocell (ETM)	36
2.2.3 Trace Port Interface Unit (TPIU)	36
2.2.4 ROM Table	36
2.2.5 Memory Protection Unit (MPU)	36
2.2.6 Nested Vectored Interrupt Controller (NVIC)	36
3 Memory Map	40
4 Interrupts	42
5 JTAG Interface	44
5.1 Block Diagram	45
5.2 Functional Description	45
5.2.1 JTAG Interface Pins	46
5.2.2 JTAG TAP Controller	47
5.2.3 Shift Registers	48
5.2.4 Operational Considerations	48
5.3 Initialization and Configuration	51
5.4 Register Descriptions	51
5.4.1 Instruction Register (IR)	51
5.4.2 Data Registers	53
6 System Control	55
6.1 Functional Description	55
6.1.1 Device Identification	55
6.1.2 Reset Control	55

6.1.3	Power Control	58
6.1.4	Clock Control	58
6.1.5	System Control	60
6.2	Initialization and Configuration	61
6.3	Register Map	61
6.4	Register Descriptions	62
7	Hibernation Module	113
7.1	Block Diagram	114
7.2	Functional Description	114
7.2.1	Register Access Timing	114
7.2.2	Clock Source	115
7.2.3	Battery Management	115
7.2.4	Real-Time Clock	115
7.2.5	Non-Volatile Memory	116
7.2.6	Power Control	116
7.2.7	Interrupts and Status	116
7.3	Initialization and Configuration	117
7.3.1	Initialization	117
7.3.2	RTC Match Functionality (No Hibernation)	117
7.3.3	RTC Match/Wake-Up from Hibernation	117
7.3.4	External Wake-Up from Hibernation	118
7.3.5	RTC/External Wake-Up from Hibernation	118
7.4	Register Map	118
7.5	Register Descriptions	119
8	Internal Memory	132
8.1	Block Diagram	132
8.2	Functional Description	132
8.2.1	SRAM Memory	132
8.2.2	Flash Memory	133
8.3	Flash Memory Initialization and Configuration	134
8.3.1	Flash Programming	134
8.3.2	Nonvolatile Register Programming	135
8.4	Register Map	135
8.5	Flash Register Descriptions (Flash Control Offset)	136
8.6	Flash Register Descriptions (System Control Offset)	143
9	General-Purpose Input/Outputs (GPIOs)	156
9.1	Functional Description	156
9.1.1	Data Control	157
9.1.2	Interrupt Control	158
9.1.3	Mode Control	159
9.1.4	Commit Control	159
9.1.5	Pad Control	159
9.1.6	Identification	159
9.2	Initialization and Configuration	159
9.3	Register Map	160
9.4	Register Descriptions	162

10	General-Purpose Timers	197
10.1	Block Diagram	197
10.2	Functional Description	198
10.2.1	GPTM Reset Conditions	199
10.2.2	32-Bit Timer Operating Modes	199
10.2.3	16-Bit Timer Operating Modes	200
10.3	Initialization and Configuration	204
10.3.1	32-Bit One-Shot/Periodic Timer Mode	204
10.3.2	32-Bit Real-Time Clock (RTC) Mode	205
10.3.3	16-Bit One-Shot/Periodic Timer Mode	205
10.3.4	16-Bit Input Edge Count Mode	206
10.3.5	16-Bit Input Edge Timing Mode	206
10.3.6	16-Bit PWM Mode	207
10.4	Register Map	207
10.5	Register Descriptions	208
11	Watchdog Timer	233
11.1	Block Diagram	233
11.2	Functional Description	233
11.3	Initialization and Configuration	234
11.4	Register Map	234
11.5	Register Descriptions	235
12	Analog-to-Digital Converter (ADC)	256
12.1	Block Diagram	257
12.2	Functional Description	257
12.2.1	Sample Sequencers	257
12.2.2	Module Control	258
12.2.3	Hardware Sample Averaging Circuit	259
12.2.4	Analog-to-Digital Converter	259
12.2.5	Test Modes	259
12.3	Initialization and Configuration	259
12.3.1	Module Initialization	259
12.3.2	Sample Sequencer Configuration	259
12.4	Register Map	260
12.5	Register Descriptions	261
13	Universal Asynchronous Receivers/Transmitters (UARTs)	288
13.1	Block Diagram	289
13.2	Functional Description	289
13.2.1	Transmit/Receive Logic	289
13.2.2	Baud-Rate Generation	290
13.2.3	Data Transmission	291
13.2.4	Serial IR (SIR)	291
13.2.5	FIFO Operation	292
13.2.6	Interrupts	292
13.2.7	Loopback Operation	293
13.2.8	IrDA SIR block	293
13.3	Initialization and Configuration	293
13.4	Register Map	294
13.5	Register Descriptions	295

14	Synchronous Serial Interface (SSI)	329
14.1	Block Diagram	329
14.2	Functional Description	329
14.2.1	Bit Rate Generation	330
14.2.2	FIFO Operation	330
14.2.3	Interrupts	330
14.2.4	Frame Formats	331
14.3	Initialization and Configuration	338
14.4	Register Map	339
14.5	Register Descriptions	340
15	Inter-Integrated Circuit (I²C) Interface	366
15.1	Block Diagram	366
15.2	Functional Description	366
15.2.1	I ² C Bus Functional Overview	367
15.2.2	Available Speed Modes	369
15.2.3	Interrupts	370
15.2.4	Loopback Operation	370
15.2.5	Command Sequence Flow Charts	371
15.3	Initialization and Configuration	377
15.4	I ² C Register Map	378
15.5	Register Descriptions (I ² C Master)	379
15.6	Register Descriptions (I ² C Slave)	392
16	Ethernet Controller	401
16.1	Block Diagram	402
16.2	Functional Description	402
16.2.1	Internal MII Operation	402
16.2.2	PHY Configuration/Operation	403
16.2.3	MAC Configuration/Operation	404
16.2.4	Interrupts	406
16.3	Initialization and Configuration	407
16.4	Ethernet Register Map	407
16.5	Ethernet MAC Register Descriptions	409
16.6	MII Management Register Descriptions	426
17	Pulse Width Modulator (PWM)	445
17.1	Block Diagram	445
17.2	Functional Description	445
17.2.1	PWM Timer	445
17.2.2	PWM Comparators	446
17.2.3	PWM Signal Generator	447
17.2.4	Dead-Band Generator	448
17.2.5	Interrupt/ADC-Trigger Selector	448
17.2.6	Synchronization Methods	448
17.2.7	Fault Conditions	449
17.2.8	Output Control Block	449
17.3	Initialization and Configuration	449
17.4	Register Map	450
17.5	Register Descriptions	451

18	Pin Diagram	480
19	Signal Tables	481
20	Operating Characteristics	494
21	Electrical Characteristics	495
21.1	DC Characteristics	495
21.1.1	Maximum Ratings	495
21.1.2	Recommended DC Operating Conditions	495
21.1.3	On-Chip Low Drop-Out (LDO) Regulator Characteristics	496
21.1.4	Power Specifications	496
21.1.5	Flash Memory Characteristics	498
21.2	AC Characteristics	498
21.2.1	Load Conditions	498
21.2.2	Clocks	498
21.2.3	Analog-to-Digital Converter	499
21.2.4	I ² C	500
21.2.5	Ethernet Controller	500
21.2.6	Hibernation Module	503
21.2.7	Synchronous Serial Interface (SSI)	504
21.2.8	JTAG and Boundary Scan	505
21.2.9	General-Purpose I/O	507
21.2.10	Reset	507
22	Package Information	510
A	Serial Flash Loader	512
A.1	Serial Flash Loader	512
A.2	Interfaces	512
A.2.1	UART	512
A.2.2	SSI	512
A.3	Packet Handling	513
A.3.1	Packet Format	513
A.3.2	Sending Packets	513
A.3.3	Receiving Packets	513
A.4	Commands	514
A.4.1	COMMAND_PING (0X20)	514
A.4.2	COMMAND_GET_STATUS (0x23)	514
A.4.3	COMMAND_DOWNLOAD (0x21)	514
A.4.4	COMMAND_SEND_DATA (0x24)	515
A.4.5	COMMAND_RUN (0x22)	515
A.4.6	COMMAND_RESET (0x25)	515
B	Register Quick Reference	517
C	Ordering and Contact Information	534
C.1	Ordering Information	534
C.2	Kits	534
C.3	Company Information	534
C.4	Support Information	535

List of Figures

Figure 1-1.	Stellaris® 6000 Series High-Level Block Diagram	27
Figure 2-1.	CPU Block Diagram	35
Figure 2-2.	TPIU Block Diagram	36
Figure 5-1.	JTAG Module Block Diagram	45
Figure 5-2.	Test Access Port State Machine	48
Figure 5-3.	IDCODE Register Format	53
Figure 5-4.	BYPASS Register Format	54
Figure 5-5.	Boundary Scan Register Format	54
Figure 6-1.	External Circuitry to Extend Reset	56
Figure 7-1.	Hibernation Module Block Diagram	114
Figure 8-1.	Flash Block Diagram	132
Figure 9-1.	GPIO Port Block Diagram	157
Figure 9-2.	GPIODATA Write Example	158
Figure 9-3.	GPIODATA Read Example	158
Figure 10-1.	GPTM Module Block Diagram	198
Figure 10-2.	16-Bit Input Edge Count Mode Example	202
Figure 10-3.	16-Bit Input Edge Time Mode Example	203
Figure 10-4.	16-Bit PWM Mode Example	204
Figure 11-1.	WDT Module Block Diagram	233
Figure 12-1.	ADC Module Block Diagram	257
Figure 13-1.	UART Module Block Diagram	289
Figure 13-2.	UART Character Frame	290
Figure 13-3.	IrDA Data Modulation	292
Figure 14-1.	SSI Module Block Diagram	329
Figure 14-2.	TI Synchronous Serial Frame Format (Single Transfer)	331
Figure 14-3.	TI Synchronous Serial Frame Format (Continuous Transfer)	332
Figure 14-4.	Freescall SPI Format (Single Transfer) with SPO=0 and SPH=0	333
Figure 14-5.	Freescall SPI Format (Continuous Transfer) with SPO=0 and SPH=0	333
Figure 14-6.	Freescall SPI Frame Format with SPO=0 and SPH=1	334
Figure 14-7.	Freescall SPI Frame Format (Single Transfer) with SPO=1 and SPH=0	335
Figure 14-8.	Freescall SPI Frame Format (Continuous Transfer) with SPO=1 and SPH=0	335
Figure 14-9.	Freescall SPI Frame Format with SPO=1 and SPH=1	336
Figure 14-10.	MICROWIRE Frame Format (Single Frame)	337
Figure 14-11.	MICROWIRE Frame Format (Continuous Transfer)	338
Figure 14-12.	MICROWIRE Frame Format, SSIFss Input Setup and Hold Requirements	338
Figure 15-1.	I ² C Block Diagram	366
Figure 15-2.	I ² C Bus Configuration	367
Figure 15-3.	START and STOP Conditions	367
Figure 15-4.	Complete Data Transfer with a 7-Bit Address	368
Figure 15-5.	R/S Bit in First Byte	368
Figure 15-6.	Data Validity During Bit Transfer on the I ² C Bus	368
Figure 15-7.	Master Single SEND	371
Figure 15-8.	Master Single RECEIVE	372
Figure 15-9.	Master Burst SEND	373
Figure 15-10.	Master Burst RECEIVE	374

Figure 15-11. Master Burst RECEIVE after Burst SEND	375
Figure 15-12. Master Burst SEND after Burst RECEIVE	376
Figure 15-13. Slave Command Sequence	377
Figure 16-1. Ethernet Controller Block Diagram	402
Figure 16-2. Ethernet Controller	402
Figure 16-3. Ethernet Frame	404
Figure 17-1. PWM Module Block Diagram	445
Figure 17-2. PWM Count-Down Mode	446
Figure 17-3. PWM Count-Up/Down Mode	447
Figure 17-4. PWM Generation Example In Count-Up/Down Mode	447
Figure 17-5. PWM Dead-Band Generator	448
Figure 18-1. Pin Connection Diagram	480
Figure 21-1. Load Conditions	498
Figure 21-2. I ² C Timing	500
Figure 21-3. External XTLP Oscillator Characteristics	503
Figure 21-4. Hibernation Module Timing	504
Figure 21-5. SSI Timing for TI Frame Format (FRF=01), Single Transfer Timing Measurement	504
Figure 21-6. SSI Timing for MICROWIRE Frame Format (FRF=10), Single Transfer	505
Figure 21-7. SSI Timing for SPI Frame Format (FRF=00), with SPH=1	505
Figure 21-8. JTAG Test Clock Input Timing	506
Figure 21-9. JTAG Test Access Port (TAP) Timing	507
Figure 21-10. JTAG TRST Timing	507
Figure 21-11. External Reset Timing ($\overline{\text{RST}}$)	508
Figure 21-12. Power-On Reset Timing	508
Figure 21-13. Brown-Out Reset Timing	508
Figure 21-14. Software Reset Timing	509
Figure 21-15. Watchdog Reset Timing	509
Figure 22-1. 100-Pin LQFP Package	510

List of Tables

Table 1.	Documentation Conventions	18
Table 3-1.	Memory Map	40
Table 4-1.	Exception Types	42
Table 4-2.	Interrupts	43
Table 5-1.	JTAG Port Pins Reset State	46
Table 5-2.	JTAG Instruction Register Commands	51
Table 6-1.	System Control Register Map	61
Table 7-1.	Hibernation Module Register Map	118
Table 8-1.	Flash Protection Policy Combinations	134
Table 8-2.	Flash Resident Registers	135
Table 8-3.	Flash Register Map	135
Table 9-1.	GPIO Pad Configuration Examples	160
Table 9-2.	GPIO Interrupt Configuration Example	160
Table 9-3.	GPIO Register Map	161
Table 10-1.	Available CCP Pins	198
Table 10-2.	16-Bit Timer With Prescaler Configurations	201
Table 10-3.	Timers Register Map	207
Table 11-1.	Watchdog Timer Register Map	234
Table 12-1.	Samples and FIFO Depth of Sequencers	257
Table 12-2.	ADC Register Map	260
Table 13-1.	UART Register Map	294
Table 14-1.	SSI Register Map	339
Table 15-1.	Examples of I ² C Master Timer Period versus Speed Mode	369
Table 15-2.	Inter-Integrated Circuit (I ² C) Interface Register Map	378
Table 15-3.	Write Field Decoding for I2CMCS[3:0] Field (Sheet 1 of 3)	383
Table 16-1.	TX & RX FIFO Organization	405
Table 16-2.	Ethernet Register Map	408
Table 17-1.	PWM Register Map	450
Table 19-1.	Signals by Pin Number	481
Table 19-2.	Signals by Signal Name	485
Table 19-3.	Signals by Function, Except for GPIO	489
Table 19-4.	GPIO Pins and Alternate Functions	492
Table 20-1.	Temperature Characteristics	494
Table 20-2.	Thermal Characteristics	494
Table 21-1.	Maximum Ratings	495
Table 21-2.	Recommended DC Operating Conditions	495
Table 21-3.	LDO Regulator Characteristics	496
Table 21-4.	Detailed Power Specifications	497
Table 21-5.	Flash Memory Characteristics	498
Table 21-6.	Phase Locked Loop (PLL) Characteristics	498
Table 21-7.	Clock Characteristics	498
Table 21-8.	Crystal Characteristics	499
Table 21-9.	ADC Characteristics	499
Table 21-10.	I ² C Characteristics	500
Table 21-11.	100BASE-TX Transmitter Characteristics	500
Table 21-12.	100BASE-TX Transmitter Characteristics (informative)	501

Table 21-13.	100BASE-TX Receiver Characteristics	501
Table 21-14.	10BASE-T Transmitter Characteristics	501
Table 21-15.	10BASE-T Transmitter Characteristics (informative)	501
Table 21-16.	10BASE-T Receiver Characteristics	501
Table 21-17.	Isolation Transformers	502
Table 21-18.	Ethernet Reference Crystal	502
Table 21-19.	External XTLP Oscillator Characteristics	503
Table 21-20.	Hibernation Module Characteristics	503
Table 21-21.	SSI Characteristics	504
Table 21-22.	JTAG Characteristics	505
Table 21-23.	GPIO Characteristics	507
Table 21-24.	Reset Characteristics	507
Table C-1.	Part Ordering Information	534

List of Registers

System Control	55
Register 1: Device Identification 0 (DID0), offset 0x000	63
Register 2: Brown-Out Reset Control (PBORCTL), offset 0x030	65
Register 3: LDO Power Control (LDOPCTL), offset 0x034	66
Register 4: Raw Interrupt Status (RIS), offset 0x050	67
Register 5: Interrupt Mask Control (IMC), offset 0x054	68
Register 6: Masked Interrupt Status and Clear (MISC), offset 0x058	69
Register 7: Reset Cause (RESC), offset 0x05C	70
Register 8: Run-Mode Clock Configuration (RCC), offset 0x060	71
Register 9: XTAL to PLL Translation (PLLCFG), offset 0x064	75
Register 10: Run-Mode Clock Configuration 2 (RCC2), offset 0x070	76
Register 11: Deep Sleep Clock Configuration (DSLPCCLKCFG), offset 0x144	78
Register 12: Device Identification 1 (DID1), offset 0x004	79
Register 13: Device Capabilities 0 (DC0), offset 0x008	81
Register 14: Device Capabilities 1 (DC1), offset 0x010	82
Register 15: Device Capabilities 2 (DC2), offset 0x014	84
Register 16: Device Capabilities 3 (DC3), offset 0x018	86
Register 17: Device Capabilities 4 (DC4), offset 0x01C	88
Register 18: Run Mode Clock Gating Control Register 0 (RCGC0), offset 0x100	90
Register 19: Sleep Mode Clock Gating Control Register 0 (SCGC0), offset 0x110	92
Register 20: Deep Sleep Mode Clock Gating Control Register 0 (DCGC0), offset 0x120	94
Register 21: Run Mode Clock Gating Control Register 1 (RCGC1), offset 0x104	96
Register 22: Sleep Mode Clock Gating Control Register 1 (SCGC1), offset 0x114	98
Register 23: Deep Sleep Mode Clock Gating Control Register 1 (DCGC1), offset 0x124	100
Register 24: Run Mode Clock Gating Control Register 2 (RCGC2), offset 0x108	102
Register 25: Sleep Mode Clock Gating Control Register 2 (SCGC2), offset 0x118	104
Register 26: Deep Sleep Mode Clock Gating Control Register 2 (DCGC2), offset 0x128	106
Register 27: Software Reset Control 0 (SRCR0), offset 0x040	108
Register 28: Software Reset Control 1 (SRCR1), offset 0x044	109
Register 29: Software Reset Control 2 (SRCR2), offset 0x048	111
Hibernation Module	113
Register 1: Hibernation RTC Counter (HIBRTCC), offset 0x000	120
Register 2: Hibernation RTC Match 0 (HIBRTCM0), offset 0x004	121
Register 3: Hibernation RTC Match 1 (HIBRTCM1), offset 0x008	122
Register 4: Hibernation RTC Load (HIBRTCLD), offset 0x00C	123
Register 5: Hibernation Control (HIBCTL), offset 0x010	124
Register 6: Hibernation Interrupt Mask (HIBIM), offset 0x014	126
Register 7: Hibernation Raw Interrupt Status (HIBRIS), offset 0x018	127
Register 8: Hibernation Masked Interrupt Status (HIBMIS), offset 0x01C	128
Register 9: Hibernation Interrupt Clear (HIBIC), offset 0x020	129
Register 10: Hibernation RTC Trim (HIBRTCT), offset 0x024	130
Register 11: Hibernation Data (HIBDATA), offset 0x030-0x12C	131
Internal Memory	132
Register 1: Flash Memory Address (FMA), offset 0x000	137
Register 2: Flash Memory Data (FMD), offset 0x004	138

Register 3:	Flash Memory Control (FMC), offset 0x008	139
Register 4:	Flash Controller Raw Interrupt Status (FCRIS), offset 0x00C	141
Register 5:	Flash Controller Interrupt Mask (FCIM), offset 0x010	142
Register 6:	Flash Controller Masked Interrupt Status and Clear (FCMISC), offset 0x014	143
Register 7:	USec Reload (USECRL), offset 0x140	144
Register 8:	Flash Memory Protection Read Enable 0 (FMPRE0), offset 0x130 and 0x200	145
Register 9:	Flash Memory Protection Program Enable 0 (FMPPE0), offset 0x134 and 0x400	146
Register 10:	User Debug (USER_DBG), offset 0x1D0	147
Register 11:	User Register 0 (USER_REG0), offset 0x1E0	148
Register 12:	User Register 1 (USER_REG1), offset 0x1E4	149
Register 13:	Flash Memory Protection Read Enable 1 (FMPRE1), offset 0x204	150
Register 14:	Flash Memory Protection Read Enable 2 (FMPRE2), offset 0x208	151
Register 15:	Flash Memory Protection Read Enable 3 (FMPRE3), offset 0x20C	152
Register 16:	Flash Memory Protection Program Enable 1 (FMPPE1), offset 0x404	153
Register 17:	Flash Memory Protection Program Enable 2 (FMPPE2), offset 0x408	154
Register 18:	Flash Memory Protection Program Enable 3 (FMPPE3), offset 0x40C	155
General-Purpose Input/Outputs (GPIOs)		156
Register 1:	GPIO Data (GPIODATA), offset 0x000	163
Register 2:	GPIO Direction (GPIODIR), offset 0x400	164
Register 3:	GPIO Interrupt Sense (GPIOIS), offset 0x404	165
Register 4:	GPIO Interrupt Both Edges (GPIOIBE), offset 0x408	166
Register 5:	GPIO Interrupt Event (GPIOIEV), offset 0x40C	167
Register 6:	GPIO Interrupt Mask (GPIOIM), offset 0x410	168
Register 7:	GPIO Raw Interrupt Status (GPIORIS), offset 0x414	169
Register 8:	GPIO Masked Interrupt Status (GPIOMIS), offset 0x418	170
Register 9:	GPIO Interrupt Clear (GPIOICR), offset 0x41C	171
Register 10:	GPIO Alternate Function Select (GPIOAFSEL), offset 0x420	172
Register 11:	GPIO 2-mA Drive Select (GPIODR2R), offset 0x500	174
Register 12:	GPIO 4-mA Drive Select (GPIODR4R), offset 0x504	175
Register 13:	GPIO 8-mA Drive Select (GPIODR8R), offset 0x508	176
Register 14:	GPIO Open Drain Select (GPIOODR), offset 0x50C	177
Register 15:	GPIO Pull-Up Select (GPIOPUR), offset 0x510	178
Register 16:	GPIO Pull-Down Select (GPIOPDR), offset 0x514	179
Register 17:	GPIO Slew Rate Control Select (GPIOSLR), offset 0x518	180
Register 18:	GPIO Digital Enable (GPIODEN), offset 0x51C	181
Register 19:	GPIO Lock (GPIOLOCK), offset 0x520	182
Register 20:	GPIO Commit (GPIOCR), offset 0x524	183
Register 21:	GPIO Peripheral Identification 4 (GPIOPeriphID4), offset 0xFD0	185
Register 22:	GPIO Peripheral Identification 5 (GPIOPeriphID5), offset 0xFD4	186
Register 23:	GPIO Peripheral Identification 6 (GPIOPeriphID6), offset 0xFD8	187
Register 24:	GPIO Peripheral Identification 7 (GPIOPeriphID7), offset 0xFDC	188
Register 25:	GPIO Peripheral Identification 0 (GPIOPeriphID0), offset 0xFE0	189
Register 26:	GPIO Peripheral Identification 1 (GPIOPeriphID1), offset 0xFE4	190
Register 27:	GPIO Peripheral Identification 2 (GPIOPeriphID2), offset 0xFE8	191
Register 28:	GPIO Peripheral Identification 3 (GPIOPeriphID3), offset 0xFEC	192
Register 29:	GPIO PrimeCell Identification 0 (GPIOPCellID0), offset 0xFF0	193
Register 30:	GPIO PrimeCell Identification 1 (GPIOPCellID1), offset 0xFF4	194
Register 31:	GPIO PrimeCell Identification 2 (GPIOPCellID2), offset 0xFF8	195

Register 32: GPIO PrimeCell Identification 3 (GPIOCellID3), offset 0xFFC	196
General-Purpose Timers	197
Register 1: GPTM Configuration (GPTMCFG), offset 0x000	209
Register 2: GPTM TimerA Mode (GPTMTAMR), offset 0x004	210
Register 3: GPTM TimerB Mode (GPTMTBMR), offset 0x008	212
Register 4: GPTM Control (GPTMCTL), offset 0x00C	214
Register 5: GPTM Interrupt Mask (GPTMIMR), offset 0x018	217
Register 6: GPTM Raw Interrupt Status (GPTMRIS), offset 0x01C	219
Register 7: GPTM Masked Interrupt Status (GPTMMIS), offset 0x020	220
Register 8: GPTM Interrupt Clear (GPTMICR), offset 0x024	221
Register 9: GPTM TimerA Interval Load (GPTMTAILR), offset 0x028	223
Register 10: GPTM TimerB Interval Load (GPTMTBILR), offset 0x02C	224
Register 11: GPTM TimerA Match (GPTMTAMATCHR), offset 0x030	225
Register 12: GPTM TimerB Match (GPTMTBMATCHR), offset 0x034	226
Register 13: GPTM TimerA Prescale (GPTMTAPR), offset 0x038	227
Register 14: GPTM TimerB Prescale (GPTMTBPR), offset 0x03C	228
Register 15: GPTM TimerA Prescale Match (GPTMTAPMR), offset 0x040	229
Register 16: GPTM TimerB Prescale Match (GPTMTBPMR), offset 0x044	230
Register 17: GPTM TimerA (GPTMTAR), offset 0x048	231
Register 18: GPTM TimerB (GPTMTBR), offset 0x04C	232
Watchdog Timer	233
Register 1: Watchdog Load (WDTLOAD), offset 0x000	236
Register 2: Watchdog Value (WDTVALUE), offset 0x004	237
Register 3: Watchdog Control (WDTCTL), offset 0x008	238
Register 4: Watchdog Interrupt Clear (WDTICR), offset 0x00C	239
Register 5: Watchdog Raw Interrupt Status (WDTRIS), offset 0x010	240
Register 6: Watchdog Masked Interrupt Status (WDTMIS), offset 0x014	241
Register 7: Watchdog Test (WDTTEST), offset 0x418	242
Register 8: Watchdog Lock (WDTLOCK), offset 0xC00	243
Register 9: Watchdog Peripheral Identification 4 (WDTPeriphID4), offset 0xFD0	244
Register 10: Watchdog Peripheral Identification 5 (WDTPeriphID5), offset 0xFD4	245
Register 11: Watchdog Peripheral Identification 6 (WDTPeriphID6), offset 0xFD8	246
Register 12: Watchdog Peripheral Identification 7 (WDTPeriphID7), offset 0xFDC	247
Register 13: Watchdog Peripheral Identification 0 (WDTPeriphID0), offset 0xFE0	248
Register 14: Watchdog Peripheral Identification 1 (WDTPeriphID1), offset 0xFE4	249
Register 15: Watchdog Peripheral Identification 2 (WDTPeriphID2), offset 0xFE8	250
Register 16: Watchdog Peripheral Identification 3 (WDTPeriphID3), offset 0xFEC	251
Register 17: Watchdog PrimeCell Identification 0 (WDTPCellID0), offset 0xFF0	252
Register 18: Watchdog PrimeCell Identification 1 (WDTPCellID1), offset 0xFF4	253
Register 19: Watchdog PrimeCell Identification 2 (WDTPCellID2), offset 0xFF8	254
Register 20: Watchdog PrimeCell Identification 3 (WDTPCellID3), offset 0xFFC	255
Analog-to-Digital Converter (ADC)	256
Register 1: ADC Active Sample Sequencer (ADCACTSS), offset 0x000	262
Register 2: ADC Raw Interrupt Status (ADCRIS), offset 0x004	263
Register 3: ADC Interrupt Mask (ADCIM), offset 0x008	264
Register 4: ADC Interrupt Status and Clear (ADCISC), offset 0x00C	265
Register 5: ADC Overflow Status (ADCOSTAT), offset 0x010	266
Register 6: ADC Event Multiplexer Select (ADCEMUX), offset 0x014	267

Register 7:	ADC Underflow Status (ADCUSTAT), offset 0x018	270
Register 8:	ADC Sample Sequencer Priority (ADCSSPRI), offset 0x020	271
Register 9:	ADC Processor Sample Sequence Initiate (ADCPSSI), offset 0x028	272
Register 10:	ADC Sample Averaging Control (ADCSAC), offset 0x030	273
Register 11:	ADC Sample Sequence Input Multiplexer Select 0 (ADCSSMUX0), offset 0x040	274
Register 12:	ADC Sample Sequence Control 0 (ADCSSCTL0), offset 0x044	276
Register 13:	ADC Sample Sequence Result FIFO 0 (ADCSSFIFO0), offset 0x048	279
Register 14:	ADC Sample Sequence Result FIFO 1 (ADCSSFIFO1), offset 0x068	279
Register 15:	ADC Sample Sequence Result FIFO 2 (ADCSSFIFO2), offset 0x088	279
Register 16:	ADC Sample Sequence Result FIFO 3 (ADCSSFIFO3), offset 0x0A8	279
Register 17:	ADC Sample Sequence FIFO 0 Status (ADCSSFSTAT0), offset 0x04C	280
Register 18:	ADC Sample Sequence FIFO 1 Status (ADCSSFSTAT1), offset 0x06C	280
Register 19:	ADC Sample Sequence FIFO 2 Status (ADCSSFSTAT2), offset 0x08C	280
Register 20:	ADC Sample Sequence FIFO 3 Status (ADCSSFSTAT3), offset 0x0AC	280
Register 21:	ADC Sample Sequence Input Multiplexer Select 1 (ADCSSMUX1), offset 0x060	281
Register 22:	ADC Sample Sequence Input Multiplexer Select 2 (ADCSSMUX2), offset 0x080	281
Register 23:	ADC Sample Sequence Control 1 (ADCSSCTL1), offset 0x064	282
Register 24:	ADC Sample Sequence Control 2 (ADCSSCTL2), offset 0x084	282
Register 25:	ADC Sample Sequence Input Multiplexer Select 3 (ADCSSMUX3), offset 0x0A0	284
Register 26:	ADC Sample Sequence Control 3 (ADCSSCTL3), offset 0x0A4	285
Register 27:	ADC Test Mode Loopback (ADCTMLB), offset 0x100	286
Universal Asynchronous Receivers/Transmitters (UARTs)		288
Register 1:	UART Data (UARTDR), offset 0x000	296
Register 2:	UART Receive Status/Error Clear (UARTRSR/UARTECR), offset 0x004	298
Register 3:	UART Flag (UARTFR), offset 0x018	300
Register 4:	UART IrDA Low-Power Register (UARTILPR), offset 0x020	302
Register 5:	UART Integer Baud-Rate Divisor (UARTIBRD), offset 0x024	303
Register 6:	UART Fractional Baud-Rate Divisor (UARTFBRD), offset 0x028	304
Register 7:	UART Line Control (UARTLCRH), offset 0x02C	305
Register 8:	UART Control (UARTCTL), offset 0x030	307
Register 9:	UART Interrupt FIFO Level Select (UARTIFLS), offset 0x034	309
Register 10:	UART Interrupt Mask (UARTIM), offset 0x038	311
Register 11:	UART Raw Interrupt Status (UARTRIS), offset 0x03C	313
Register 12:	UART Masked Interrupt Status (UARTMIS), offset 0x040	314
Register 13:	UART Interrupt Clear (UARTICR), offset 0x044	315
Register 14:	UART Peripheral Identification 4 (UARTPeriphID4), offset 0xFD0	317
Register 15:	UART Peripheral Identification 5 (UARTPeriphID5), offset 0xFD4	318
Register 16:	UART Peripheral Identification 6 (UARTPeriphID6), offset 0xFD8	319
Register 17:	UART Peripheral Identification 7 (UARTPeriphID7), offset 0xFDC	320
Register 18:	UART Peripheral Identification 0 (UARTPeriphID0), offset 0xFE0	321
Register 19:	UART Peripheral Identification 1 (UARTPeriphID1), offset 0xFE4	322
Register 20:	UART Peripheral Identification 2 (UARTPeriphID2), offset 0xFE8	323
Register 21:	UART Peripheral Identification 3 (UARTPeriphID3), offset 0xFEC	324
Register 22:	UART PrimeCell Identification 0 (UARTPCellID0), offset 0xFF0	325
Register 23:	UART PrimeCell Identification 1 (UARTPCellID1), offset 0xFF4	326
Register 24:	UART PrimeCell Identification 2 (UARTPCellID2), offset 0xFF8	327
Register 25:	UART PrimeCell Identification 3 (UARTPCellID3), offset 0xFFC	328

Synchronous Serial Interface (SSI)	329
Register 1: SSI Control 0 (SSICR0), offset 0x000	341
Register 2: SSI Control 1 (SSICR1), offset 0x004	343
Register 3: SSI Data (SSIDR), offset 0x008	345
Register 4: SSI Status (SSISR), offset 0x00C	346
Register 5: SSI Clock Prescale (SSICPSR), offset 0x010	348
Register 6: SSI Interrupt Mask (SSIIM), offset 0x014	349
Register 7: SSI Raw Interrupt Status (SSIRIS), offset 0x018	351
Register 8: SSI Masked Interrupt Status (SSIMIS), offset 0x01C	352
Register 9: SSI Interrupt Clear (SSIICR), offset 0x020	353
Register 10: SSI Peripheral Identification 4 (SSIPeriphID4), offset 0xFD0	354
Register 11: SSI Peripheral Identification 5 (SSIPeriphID5), offset 0xFD4	355
Register 12: SSI Peripheral Identification 6 (SSIPeriphID6), offset 0xFD8	356
Register 13: SSI Peripheral Identification 7 (SSIPeriphID7), offset 0xFDC	357
Register 14: SSI Peripheral Identification 0 (SSIPeriphID0), offset 0xFE0	358
Register 15: SSI Peripheral Identification 1 (SSIPeriphID1), offset 0xFE4	359
Register 16: SSI Peripheral Identification 2 (SSIPeriphID2), offset 0xFE8	360
Register 17: SSI Peripheral Identification 3 (SSIPeriphID3), offset 0xFEC	361
Register 18: SSI PrimeCell Identification 0 (SSIPCellID0), offset 0xFF0	362
Register 19: SSI PrimeCell Identification 1 (SSIPCellID1), offset 0xFF4	363
Register 20: SSI PrimeCell Identification 2 (SSIPCellID2), offset 0xFF8	364
Register 21: SSI PrimeCell Identification 3 (SSIPCellID3), offset 0xFFC	365
Inter-Integrated Circuit (I²C) Interface	366
Register 1: I ² C Master Slave Address (I2CMSA), offset 0x000	380
Register 2: I ² C Master Control/Status (I2CMCS), offset 0x004	381
Register 3: I ² C Master Data (I2CMDR), offset 0x008	385
Register 4: I ² C Master Timer Period (I2CMTPR), offset 0x00C	386
Register 5: I ² C Master Interrupt Mask (I2CMIMR), offset 0x010	387
Register 6: I ² C Master Raw Interrupt Status (I2CMRIS), offset 0x014	388
Register 7: I ² C Master Masked Interrupt Status (I2CMMIS), offset 0x018	389
Register 8: I ² C Master Interrupt Clear (I2CMICR), offset 0x01C	390
Register 9: I ² C Master Configuration (I2CMCR), offset 0x020	391
Register 10: I ² C Slave Own Address (I2CSOAR), offset 0x000	393
Register 11: I ² C Slave Control/Status (I2CSCSR), offset 0x004	394
Register 12: I ² C Slave Data (I2CSDR), offset 0x008	396
Register 13: I ² C Slave Interrupt Mask (I2CSIMR), offset 0x00C	397
Register 14: I ² C Slave Raw Interrupt Status (I2CSRIS), offset 0x010	398
Register 15: I ² C Slave Masked Interrupt Status (I2CSMIS), offset 0x014	399
Register 16: I ² C Slave Interrupt Clear (I2CSICR), offset 0x018	400
Ethernet Controller	401
Register 1: Ethernet MAC Raw Interrupt Status (MACRIS), offset 0x000	410
Register 2: Ethernet MAC Interrupt Acknowledge (MACIACK), offset 0x000	412
Register 3: Ethernet MAC Interrupt Mask (MACIM), offset 0x004	413
Register 4: Ethernet MAC Receive Control (MACRCTL), offset 0x008	414
Register 5: Ethernet MAC Transmit Control (MACTCTL), offset 0x00C	415
Register 6: Ethernet MAC Data (MACDATA), offset 0x010	416
Register 7: Ethernet MAC Individual Address 0 (MACIA0), offset 0x014	418

Register 8:	Ethernet MAC Individual Address 1 (MACIA1), offset 0x018	419
Register 9:	Ethernet MAC Threshold (MACTHR), offset 0x01C	420
Register 10:	Ethernet MAC Management Control (MACMCTL), offset 0x020	421
Register 11:	Ethernet MAC Management Divider (MACMDV), offset 0x024	422
Register 12:	Ethernet MAC Management Transmit Data (MACMTXD), offset 0x02C	423
Register 13:	Ethernet MAC Management Receive Data (MACMRXD), offset 0x030	424
Register 14:	Ethernet MAC Number of Packets (MACNP), offset 0x034	425
Register 15:	Ethernet MAC Transmission Request (MACTR), offset 0x038	426
Register 16:	Ethernet PHY Management Register 0 – Control (MR0), address 0x00	427
Register 17:	Ethernet PHY Management Register 1 – Status (MR1), address 0x01	429
Register 18:	Ethernet PHY Management Register 2 – PHY Identifier 1 (MR2), address 0x02	431
Register 19:	Ethernet PHY Management Register 3 – PHY Identifier 2 (MR3), address 0x03	432
Register 20:	Ethernet PHY Management Register 4 – Auto-Negotiation Advertisement (MR4), address 0x04	433
Register 21:	Ethernet PHY Management Register 5 – Auto-Negotiation Link Partner Base Page Ability (MR5), address 0x05	435
Register 22:	Ethernet PHY Management Register 6 – Auto-Negotiation Expansion (MR6), address 0x06	436
Register 23:	Ethernet PHY Management Register 16 – Vendor-Specific (MR16), address 0x10	437
Register 24:	Ethernet PHY Management Register 17 – Interrupt Control/Status (MR17), address 0x11	439
Register 25:	Ethernet PHY Management Register 18 – Diagnostic (MR18), address 0x12	441
Register 26:	Ethernet PHY Management Register 19 – Transceiver Control (MR19), address 0x13	442
Register 27:	Ethernet PHY Management Register 23 – LED Configuration (MR23), address 0x17	443
Register 28:	Ethernet PHY Management Register 24 –MDI/MDIX Control (MR24), address 0x18	444
Pulse Width Modulator (PWM)		445
Register 1:	PWM Master Control (PWMCTL), offset 0x000	452
Register 2:	PWM Time Base Sync (PWMSYNC), offset 0x004	453
Register 3:	PWM Output Enable (PWMENABLE), offset 0x008	454
Register 4:	PWM Output Inversion (PWMINVERT), offset 0x00C	455
Register 5:	PWM Output Fault (PWMFAULT), offset 0x010	456
Register 6:	PWM Interrupt Enable (PWMINTEN), offset 0x014	457
Register 7:	PWM Raw Interrupt Status (PWMRIS), offset 0x018	458
Register 8:	PWM Interrupt Status and Clear (PWMISC), offset 0x01C	459
Register 9:	PWM Status (PWMSTATUS), offset 0x020	460
Register 10:	PWM0 Control (PWM0CTL), offset 0x040	461
Register 11:	PWM0 Interrupt and Trigger Enable (PWM0INTEN), offset 0x044	463
Register 12:	PWM0 Raw Interrupt Status (PWM0RIS), offset 0x048	465
Register 13:	PWM0 Interrupt Status and Clear (PWM0ISC), offset 0x04C	466
Register 14:	PWM0 Load (PWM0LOAD), offset 0x050	467
Register 15:	PWM0 Counter (PWM0COUNT), offset 0x054	468
Register 16:	PWM0 Compare A (PWM0CMPA), offset 0x058	469
Register 17:	PWM0 Compare B (PWM0CMPB), offset 0x05C	470
Register 18:	PWM0 Generator A Control (PWM0GENA), offset 0x060	471
Register 19:	PWM0 Generator B Control (PWM0GENB), offset 0x064	474
Register 20:	PWM0 Dead-Band Control (PWM0DBCTL), offset 0x068	477
Register 21:	PWM0 Dead-Band Rising-Edge Delay (PWM0DBRISE), offset 0x06C	478
Register 22:	PWM0 Dead-Band Falling-Edge-Delay (PWM0DBFALL), offset 0x070	479

About This Document

This data sheet provides reference information for the LM3S6916 microcontroller, describing the functional blocks of the system-on-chip (SoC) device designed around the ARM® Cortex™-M3 core.

Audience

This manual is intended for system software developers, hardware designers, and application developers.

About This Manual

This document is organized into sections that correspond to each major feature.

Related Documents

The following documents are referenced by the data sheet, and available on the documentation CD or from the Luminary Micro web site at www.luminarymicro.com:

- *ARM® Cortex™-M3 Technical Reference Manual*
- *ARM® CoreSight Technical Reference Manual*
- *ARM® v7-M Architecture Application Level Reference Manual*

The following related documents are also referenced:

- *IEEE Standard 1149.1-Test Access Port and Boundary-Scan Architecture*

This documentation list was current as of publication date. Please check the Luminary Micro web site for additional documentation, including application notes and white papers.

Documentation Conventions

This document uses the conventions shown in Table 1 on page 18.

Table 1. Documentation Conventions

Notation	Meaning
General Register Notation	
REGISTER	APB registers are indicated in uppercase bold. For example, PBORCTL is the Power-On and Brown-Out Reset Control register. If a register name contains a lowercase n, it represents more than one register. For example, SRCRn represents any (or all) of the three Software Reset Control registers: SRCR0 , SRCR1 , and SRCR2 .
bit	A single bit in a register.
bit field	Two or more consecutive and related bits.
offset 0xnnn	A hexadecimal increment to a register's address, relative to that module's base address as specified in "Memory Map" on page 40.
Register N	Registers are numbered consecutively throughout the document to aid in referencing them. The register number has no meaning to software.

Notation	Meaning
reserved	Register bits marked <i>reserved</i> are reserved for future use. In most cases, reserved bits are set to 0; however, user software should not rely on the value of a reserved bit. To provide software compatibility with future products, the value of a reserved bit should be preserved across a read-modify-write operation.
yy:xx	The range of register bits inclusive from xx to yy. For example, 31:15 means bits 15 through 31 in that register.
Register Bit/Field Types	This value in the register bit diagram indicates whether software running on the controller can change the value of the bit field.
RC	Software can read this field. The bit or field is cleared by hardware after reading the bit/field.
RO	Software can read this field. Always write the chip reset value.
R/W	Software can read or write this field.
R/W1C	Software can read or write this field. A write of a 0 to a W1C bit does not affect the bit value in the register. A write of a 1 clears the value of the bit in the register; the remaining bits remain unchanged. This register type is primarily used for clearing interrupt status bits where the read operation provides the interrupt status and the write of the read value clears only the interrupts being reported at the time the register was read.
W1C	Software can write this field. A write of a 0 to a W1C bit does not affect the bit value in the register. A write of a 1 clears the value of the bit in the register; the remaining bits remain unchanged. A read of the register returns no meaningful data. This register is typically used to clear the corresponding bit in an interrupt register.
WO	Only a write by software is valid; a read of the register returns no meaningful data.
Register Bit/Field Reset Value	This value in the register bit diagram shows the bit/field value after any reset, unless noted.
0	Bit cleared to 0 on chip reset.
1	Bit set to 1 on chip reset.
-	Nondeterministic.
Pin/Signal Notation	
[]	Pin alternate function; a pin defaults to the signal without the brackets.
pin	Refers to the physical connection on the package.
signal	Refers to the electrical signal encoding of a pin.
assert a signal	Change the value of the signal from the logically False state to the logically True state. For active High signals, the asserted signal value is 1 (High); for active Low signals, the asserted signal value is 0 (Low). The active polarity (High or Low) is defined by the signal name (see <code>SIGNAL</code> and <code>̄SIGNAL</code> below).
deassert a signal	Change the value of the signal from the logically True state to the logically False state.
<code>̄SIGNAL</code>	Signal names are in uppercase and in the Courier font. An overbar on a signal name indicates that it is active Low. To assert <code>̄SIGNAL</code> is to drive it Low; to deassert <code>̄SIGNAL</code> is to drive it High.
<code>SIGNAL</code>	Signal names are in uppercase and in the Courier font. An active High signal has no overbar. To assert <code>SIGNAL</code> is to drive it High; to deassert <code>SIGNAL</code> is to drive it Low.
Numbers	
X	An uppercase X indicates any of several values is allowed, where X can be any legal pattern. For example, a binary value of 0X00 can be either 0100 or 0000, a hex value of 0xX is 0x0 or 0x1, and so on.
0x	Hexadecimal numbers have a prefix of 0x. For example, 0x00FF is the hexadecimal number FF. All other numbers within register tables are assumed to be binary. Within conceptual information, binary numbers are indicated with a b suffix, for example, 1011b, and decimal numbers are written without a prefix or suffix.

1 Architectural Overview

The Luminary Micro Stellaris[®] family of microcontrollers—the first ARM[®] Cortex™-M3 based controllers—brings high-performance 32-bit computing to cost-sensitive embedded microcontroller applications. These pioneering parts deliver customers 32-bit performance at a cost equivalent to legacy 8- and 16-bit devices, all in a package with a small footprint.

The Stellaris[®] family offers efficient performance and extensive integration, favorably positioning the device into cost-conscious applications requiring significant control-processing and connectivity capabilities. The Stellaris[®] LM3S1000 series extends the Stellaris[®] family with larger on-chip memories, enhanced power management, and expanded I/O and control capabilities. The Stellaris[®] LM3S2000 series, designed for Controller Area Network (CAN) applications, extends the Stellaris family with Bosch CAN networking technology, the golden standard in short-haul industrial networks. The Stellaris[®] LM3S2000 series also marks the first integration of CAN capabilities with the revolutionary Cortex-M3 core. The Stellaris[®] LM3S6000 series combines both a 10/100 Ethernet Media Access Control (MAC) and Physical (PHY) layer, marking the first time that integrated connectivity is available with an ARM Cortex-M3 MCU and the only integrated 10/100 Ethernet MAC and PHY available in an ARM architecture MCU. The Stellaris[®] LM3S8000 series combines Bosch Controller Area Network technology with both a 10/100 Ethernet Media Access Control (MAC) and Physical (PHY) layer.

The LM3S6916 microcontroller is targeted for industrial applications, including remote monitoring, electronic point-of-sale machines, test and measurement equipment, network appliances and switches, factory automation, HVAC and building control, gaming equipment, motion control, medical instrumentation, and fire and security.

For applications requiring extreme conservation of power, the LM3S6916 microcontroller features a Battery-backed Hibernation module to efficiently power down the LM3S6916 to a low-power state during extended periods of inactivity. With a power-up/power-down sequencer, a continuous time counter (RTC), a pair of match registers, an APB interface to the system bus, and dedicated non-volatile memory, the Hibernation module positions the LM3S6916 microcontroller perfectly for battery applications.

In addition, the LM3S6916 microcontroller offers the advantages of ARM's widely available development tools, System-on-Chip (SoC) infrastructure IP applications, and a large user community. Additionally, the microcontroller uses ARM's Thumb[®]-compatible Thumb-2 instruction set to reduce memory requirements and, thereby, cost. Finally, the LM3S6916 microcontroller is code-compatible to all members of the extensive Stellaris[®] family; providing flexibility to fit our customers' precise needs.

Luminary Micro offers a complete solution to get to market quickly, with evaluation and development boards, white papers and application notes, an easy-to-use peripheral driver library, and a strong support, sales, and distributor network.

1.1 Product Features

The LM3S6916 microcontroller includes the following product features:

- 32-Bit RISC Performance
 - 32-bit ARM[®] Cortex™-M3 v7M architecture optimized for small-footprint embedded applications

- System timer (SysTick), providing a simple, 24-bit clear-on-write, decrementing, wrap-on-zero counter with a flexible control mechanism
- Thumb®-compatible Thumb-2-only instruction set processor core for high code density
- 50-MHz operation
- Hardware-division and single-cycle-multiplication
- Integrated Nested Vectored Interrupt Controller (NVIC) providing deterministic interrupt handling
- 31 interrupts with eight priority levels
- Memory protection unit (MPU), providing a privileged mode for protected operating system functionality
- Unaligned data access, enabling data to be efficiently packed into memory
- Atomic bit manipulation (bit-banding), delivering maximum memory utilization and streamlined peripheral control
- Internal Memory
 - 256 KB single-cycle flash
 - User-managed flash block protection on a 2-KB block basis
 - User-managed flash data programming
 - User-defined and managed flash-protection block
 - 64 KB single-cycle SRAM
- General-Purpose Timers
 - Four General-Purpose Timer Modules (GPTM), each of which provides two 16-bit timers. Each GPTM can be configured to operate independently:
 - As a single 32-bit timer
 - As one 32-bit Real-Time Clock (RTC) to event capture
 - For Pulse Width Modulation (PWM)
 - To trigger analog-to-digital conversions
 - 32-bit Timer modes
 - Programmable one-shot timer
 - Programmable periodic timer
 - Real-Time Clock when using an external 32.768-KHz clock as the input

- User-enabled stalling in periodic and one-shot mode when the controller asserts the CPU Halt flag during debug
- ADC event trigger
- 16-bit Timer modes
 - General-purpose timer function with an 8-bit prescaler
 - Programmable one-shot timer
 - Programmable periodic timer
 - User-enabled stalling when the controller asserts CPU Halt flag during debug
 - ADC event trigger
- 16-bit Input Capture modes
 - Input edge count capture
 - Input edge time capture
- 16-bit PWM mode
 - Simple PWM mode with software-programmable output inversion of the PWM signal
- ARM FiRM-compliant Watchdog Timer
 - 32-bit down counter with a programmable load register
 - Separate watchdog clock with an enable
 - Programmable interrupt generation logic with interrupt masking
 - Lock register protection from runaway software
 - Reset generation logic with an enable/disable
 - User-enabled stalling when the controller asserts the CPU Halt flag during debug
- 10/100 Ethernet Controller
 - Conforms to the IEEE 802.3-2002 Specification
 - Full- and half-duplex for both 100 Mbps and 10 Mbps operation
 - Integrated 10/100 Mbps Transceiver (PHY)
 - Automatic MDI/MDI-X cross-over correction
 - Programmable MAC address
 - Power-saving and power-down modes
- Synchronous Serial Interface (SSI)

- Master or slave operation
- Programmable clock bit rate and prescale
- Separate transmit and receive FIFOs, 16 bits wide, 8 locations deep
- Programmable interface operation for Freescale SPI, MICROWIRE, or Texas Instruments synchronous serial interfaces
- Programmable data frame size from 4 to 16 bits
- Internal loopback test mode for diagnostic/debug testing
- UART
 - Three fully programmable 16C550-type UARTs with IrDA support
 - Separate 16x8 transmit (TX) and 16x12 receive (RX) FIFOs to reduce CPU interrupt service loading
 - Programmable baud-rate generator with fractional divider
 - Programmable FIFO length, including 1-byte deep operation providing conventional double-buffered interface
 - FIFO trigger levels of 1/8, 1/4, 1/2, 3/4, and 7/8
 - Standard asynchronous communication bits for start, stop, and parity
 - False-start-bit detection
 - Line-break generation and detection
- ADC
 - Single- and differential-input configurations
 - Six 10-bit channels (inputs) when used as single-ended inputs
 - Sample rate of 500 thousand samples/second
 - Flexible, configurable analog-to-digital conversion
 - Four programmable sample conversion sequences from one to eight entries long, with corresponding conversion result FIFOs
 - Each sequence triggered by software or internal event (timers, PWM or GPIO)
- I²C
 - Master and slave receive and transmit operation with transmission speed up to 100 Kbps in Standard mode and 400 Kbps in Fast mode
 - Interrupt generation

- Master with arbitration and clock synchronization, multimaster support, and 7-bit addressing mode
- PWM
 - One PWM generator blocks, each with one 16-bit counter, two comparators, a PWM generator, and a dead-band generator
 - One 16-bit counter
 - Runs in Down or Up/Down mode
 - Output frequency controlled by a 16-bit load value
 - Load value updates can be synchronized
 - Produces output signals at zero and load value
 - Two PWM comparators
 - Comparator value updates can be synchronized
 - Produces output signals on match
 - PWM generator
 - Output PWM signal is constructed based on actions taken as a result of the counter and PWM comparator output signals
 - Produces two independent PWM signals
 - Dead-band generator
 - Produces two PWM signals with programmable dead-band delays suitable for driving a half-H bridge
 - Can be bypassed, leaving input PWM signals unmodified
 - Flexible output control block with PWM output enable of each PWM signal
 - PWM output enable of each PWM signal
 - Optional output inversion of each PWM signal (polarity control)
 - Optional fault handling for each PWM signal
 - Synchronization of timers in the PWM generator blocks
 - Synchronization of timer/comparator updates across the PWM generator blocks
 - Interrupt status summary of the PWM generator blocks
 - Can initiate an ADC sample sequence
- GPIOs
 - 7-35 GPIOs, depending on configuration

- 5-V-tolerant input/outputs
- Programmable interrupt generation as either edge-triggered or level-sensitive
- Bit masking in both read and write operations through address lines
- Can initiate an ADC sample sequence
- Programmable control for GPIO pad configuration:
 - Weak pull-up or pull-down resistors
 - 2-mA, 4-mA, and 8-mA pad drive
 - Slew rate control for the 8-mA drive
 - Open drain enables
 - Digital input enables
- Power
 - On-chip Low Drop-Out (LDO) voltage regulator, with programmable output user-adjustable from 2.25 V to 2.75 V
 - Hibernation module handles the power-up/down 3.3 V sequencing and control for the core digital logic and analog circuits
 - Low-power options on controller: Sleep and Deep-sleep modes
 - Low-power options for peripherals: software controls shutdown of individual peripherals
 - User-enabled LDO unregulated voltage detection and automatic reset
 - 3.3-V supply brown-out detection and reporting via interrupt or reset
- Flexible Reset Sources
 - Power-on reset (POR)
 - Reset pin assertion
 - Brown-out (BOR) detector alerts to system power drops
 - Software reset
 - Watchdog timer reset
 - Internal low drop-out (LDO) regulator output goes unregulated
- Additional Features
 - Six reset sources
 - Programmable clock source control
 - Clock gating to individual peripherals for power savings

- IEEE 1149.1-1990 compliant Test Access Port (TAP) controller
- Debug access via JTAG and Serial Wire interfaces
- Full JTAG boundary scan
- Industrial-range 100-pin RoHS-compliant LQFP package

1.2 Target Applications

- Remote monitoring
- Electronic point-of-sale (POS) machines
- Test and measurement equipment
- Network appliances and switches
- Factory automation
- HVAC and building control
- Gaming equipment
- Motion control
- Medical instrumentation
- Fire and security
- Power and energy
- Transportation

1.3 High-Level Block Diagram

Figure 1-1 on page 27 represents the full set of features in the Stellaris[®] 6000 series of devices; not all features may be available on the LM3S6916 microcontroller.

Figure 1-1. Stellaris® 6000 Series High-Level Block Diagram

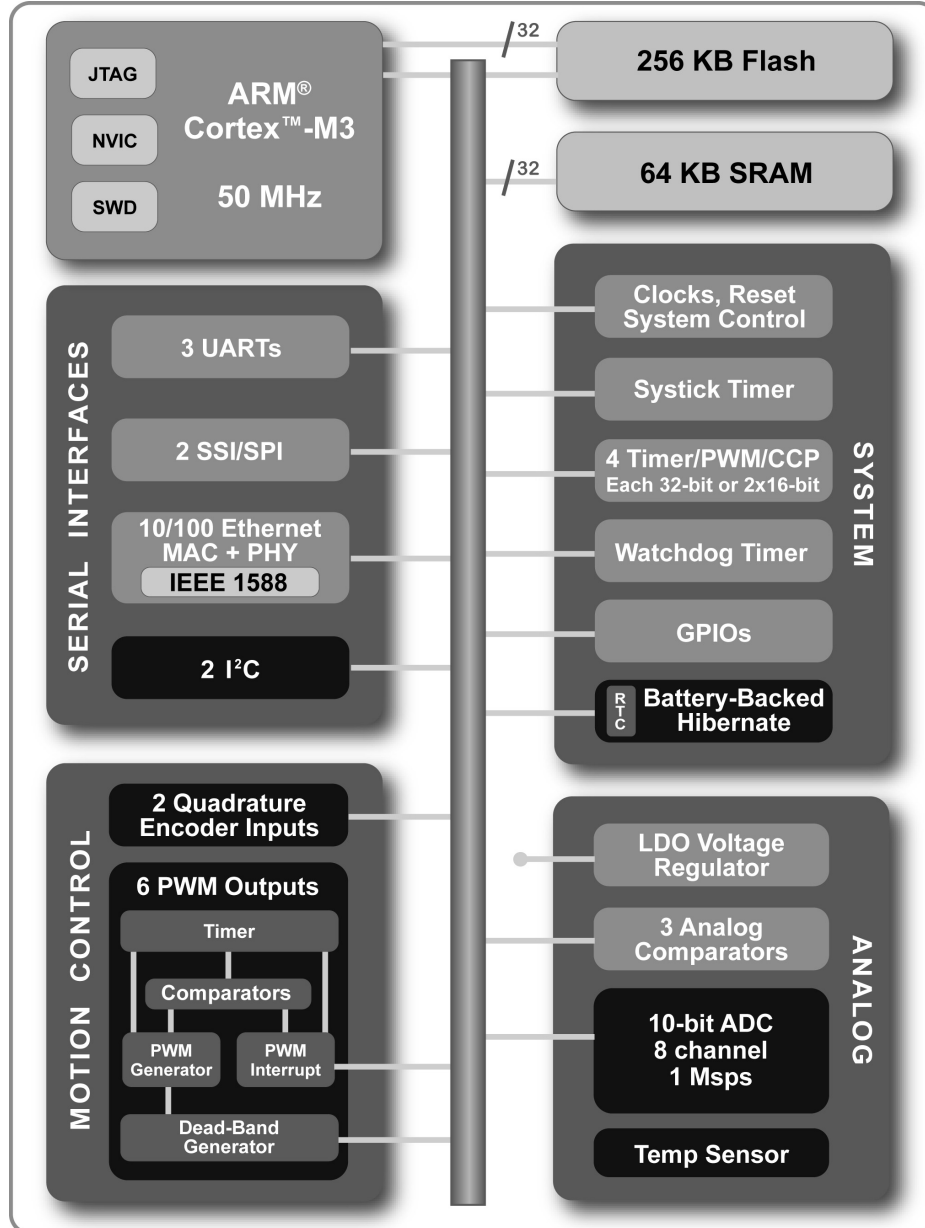

1.4 Functional Overview

The following sections provide an overview of the features of the LM3S6916 microcontroller. The page number in parenthesis indicates where that feature is discussed in detail. Ordering and support information can be found in “Ordering and Contact Information” on page 534.

1.4.1 ARM Cortex™-M3

1.4.1.1 Processor Core (see page 34)

All members of the Stellaris® product family, including the LM3S6916 microcontroller, are designed around an ARM Cortex™-M3 processor core. The ARM Cortex-M3 processor provides the core for a high-performance, low-cost platform that meets the needs of minimal memory implementation, reduced pin count, and low-power consumption, while delivering outstanding computational performance and exceptional system response to interrupts.

“ARM Cortex-M3 Processor Core” on page 34 provides an overview of the ARM core; the core is detailed in the *ARM® Cortex™-M3 Technical Reference Manual*.

1.4.1.2 System Timer (SysTick)

Cortex-M3 includes an integrated system timer, SysTick. SysTick provides a simple, 24-bit clear-on-write, decrementing, wrap-on-zero counter with a flexible control mechanism. The counter can be used in several different ways, for example:

- An RTOS tick timer which fires at a programmable rate (for example, 100 Hz) and invokes a SysTick routine.
- A high-speed alarm timer using the system clock.
- A variable rate alarm or signal timer—the duration is range-dependent on the reference clock used and the dynamic range of the counter.
- A simple counter. Software can use this to measure time to completion and time used.
- An internal clock source control based on missing/meeting durations. The COUNTFLAG bit-field in the control and status register can be used to determine if an action completed within a set duration, as part of a dynamic clock management control loop.

1.4.1.3 Nested Vectored Interrupt Controller (NVIC)

The LM3S6916 controller includes the ARM Nested Vectored Interrupt Controller (NVIC) on the ARM Cortex-M3 core. The NVIC and Cortex-M3 prioritize and handle all exceptions. All exceptions are handled in Handler Mode. The processor state is automatically stored to the stack on an exception, and automatically restored from the stack at the end of the Interrupt Service Routine (ISR). The vector is fetched in parallel to the state saving, which enables efficient interrupt entry. The processor supports tail-chaining, which enables back-to-back interrupts to be performed without the overhead of state saving and restoration. Software can set eight priority levels on 7 exceptions (system handlers) and 31 interrupts.

“Interrupts” on page 42 provides an overview of the NVIC controller and the interrupt map. Exceptions and interrupts are detailed in the *ARM® Cortex™-M3 Technical Reference Manual*.

1.4.2 Motor Control Peripherals

To enhance motor control, the LM3S6916 controller features Pulse Width Modulation (PWM) outputs.

1.4.2.1 PWM

Pulse width modulation (PWM) is a powerful technique for digitally encoding analog signal levels. High-resolution counters are used to generate a square wave, and the duty cycle of the square wave is modulated to encode an analog signal. Typical applications include switching power supplies and motor control.

On the LM3S6916, PWM motion control functionality can be achieved through:

- Dedicated, flexible motion control hardware using the PWM pins
- The motion control features of the general-purpose timers using the CCP pins

PWM Pins (see page 445)

The LM3S6916 PWM module consists of one PWM generator blocks and a control block. Each PWM generator block contains one timer (16-bit down or up/down counter), two comparators, a PWM signal generator, a dead-band generator, and an interrupt/ADC-trigger selector. The control block determines the polarity of the PWM signals, and which signals are passed through to the pins.

Each PWM generator block produces two PWM signals that can either be independent signals or a single pair of complementary signals with dead-band delays inserted. The output of the PWM generation blocks are managed by the output control block before being passed to the device pins.

CCP Pins (see page 203)

The General-Purpose Timer Module's CCP (Capture Compare PWM) pins are software programmable to support a simple PWM mode with a software-programmable output inversion of the PWM signal.

1.4.3 Analog Peripherals

To handle analog signals, the LM3S6916 microcontroller offers an Analog-to-Digital Converter (ADC).

1.4.3.1 ADC (see page 256)

An analog-to-digital converter (ADC) is a peripheral that converts a continuous analog voltage to a discrete digital number.

The LM3S6916 ADC module features 10-bit conversion resolution and supports six input channels. Four buffered sample sequences allow rapid sampling of up to eight analog input sources without controller intervention. Each sample sequence provides flexible programming with fully configurable input source, trigger events, interrupt generation, and sequence priority.

1.4.4 Serial Communications Peripherals

The LM3S6916 controller supports both asynchronous and synchronous serial communications with:

- Three fully programmable 16C550-type UARTs
- One SSI module
- One I²C module
- Ethernet controller

1.4.4.1 UART (see page 288)

A Universal Asynchronous Receiver/Transmitter (UART) is an integrated circuit used for RS-232C serial communications, containing a transmitter (parallel-to-serial converter) and a receiver (serial-to-parallel converter), each clocked separately.

The LM3S6916 controller includes three fully programmable 16C550-type UARTs that support data transfer speeds up to 460.8 Kbps. (Although similar in functionality to a 16C550 UART, it is not register-compatible.) In addition, each UART is capable of supporting IrDA.

Separate 16x8 transmit (TX) and 16x12 receive (RX) FIFOs reduce CPU interrupt service loading. The UART can generate individually masked interrupts from the RX, TX, modem status, and error conditions. The module provides a single combined interrupt when any of the interrupts are asserted and are unmasked.

1.4.4.2 SSI (see page 329)

Synchronous Serial Interface (SSI) is a four-wire bi-directional communications interface.

The LM3S6916 controller includes one SSI module that provides the functionality for synchronous serial communications with peripheral devices, and can be configured to use the Freescale SPI, MICROWIRE, or TI synchronous serial interface frame formats. The size of the data frame is also configurable, and can be set between 4 and 16 bits, inclusive.

The SSI module performs serial-to-parallel conversion on data received from a peripheral device, and parallel-to-serial conversion on data transmitted to a peripheral device. The TX and RX paths are buffered with internal FIFOs, allowing up to eight 16-bit values to be stored independently.

The SSI module can be configured as either a master or slave device. As a slave device, the SSI module can also be configured to disable its output, which allows a master device to be coupled with multiple slave devices.

The SSI module also includes a programmable bit rate clock divider and prescaler to generate the output serial clock derived from the SSI module's input clock. Bit rates are generated based on the input clock and the maximum bit rate is determined by the connected peripheral.

1.4.4.3 I²C (see page 366)

The Inter-Integrated Circuit (I²C) bus provides bi-directional data transfer through a two-wire design (a serial data line SDA and a serial clock line SCL).

The I²C bus interfaces to external I²C devices such as serial memory (RAMs and ROMs), networking devices, LCDs, tone generators, and so on. The I²C bus may also be used for system testing and diagnostic purposes in product development and manufacture.

The LM3S6916 controller includes one I²C module that provides the ability to communicate to other IC devices over an I²C bus. The I²C bus supports devices that can both transmit and receive (write and read) data.

Devices on the I²C bus can be designated as either a master or a slave. The I²C module supports both sending and receiving data as either a master or a slave, and also supports the simultaneous operation as both a master and a slave. The four I²C modes are: Master Transmit, Master Receive, Slave Transmit, and Slave Receive.

A Stellaris[®] I²C module can operate at two speeds: Standard (100 Kbps) and Fast (400 Kbps).

Both the I²C master and slave can generate interrupts. The I²C master generates interrupts when a transmit or receive operation completes (or aborts due to an error). The I²C slave generates interrupts when data has been sent or requested by a master.

1.4.4.4 Ethernet Controller (see page 401)

Ethernet is a frame-based computer networking technology for local area networks (LANs). Ethernet has been standardized as IEEE 802.3. It defines a number of wiring and signaling standards for the

physical layer, two means of network access at the Media Access Control (MAC)/Data Link Layer, and a common addressing format.

The Stellaris® Ethernet Controller consists of a fully integrated media access controller (MAC) and network physical (PHY) interface device. The Ethernet Controller conforms to IEEE 802.3 specifications and fully supports 10BASE-T and 100BASE-TX standards. In addition, the Ethernet Controller supports automatic MDI/MDI-X cross-over correction.

1.4.5 System Peripherals

1.4.5.1 Programmable GPIOs (see page 156)

General-purpose input/output (GPIO) pins offer flexibility for a variety of connections.

The Stellaris® GPIO module is composed of seven physical GPIO blocks, each corresponding to an individual GPIO port. The GPIO module is FiRM-compliant (compliant to the ARM Foundation IP for Real-Time Microcontrollers specification) and supports 7-35 programmable input/output pins. The number of GPIOs available depends on the peripherals being used (see “Signal Tables” on page 481 for the signals available to each GPIO pin).

The GPIO module features programmable interrupt generation as either edge-triggered or level-sensitive on all pins, programmable control for GPIO pad configuration, and bit masking in both read and write operations through address lines.

1.4.5.2 Four Programmable Timers (see page 197)

Programmable timers can be used to count or time external events that drive the Timer input pins.

The Stellaris® General-Purpose Timer Module (GPTM) contains four GPTM blocks. Each GPTM block provides two 16-bit timers/counters that can be configured to operate independently as timers or event counters, or configured to operate as one 32-bit timer or one 32-bit Real-Time Clock (RTC). Timers can also be used to trigger analog-to-digital (ADC) conversions.

When configured in 32-bit mode, a timer can run as a Real-Time Clock (RTC), one-shot timer or periodic timer. When in 16-bit mode, a timer can run as a one-shot timer or periodic timer, and can extend its precision by using an 8-bit prescaler. A 16-bit timer can also be configured for event capture or Pulse Width Modulation (PWM) generation.

1.4.5.3 Watchdog Timer (see page 233)

A watchdog timer can generate nonmaskable interrupts (NMIs) or a reset when a time-out value is reached. The watchdog timer is used to regain control when a system has failed due to a software error or to the failure of an external device to respond in the expected way.

The Stellaris® Watchdog Timer module consists of a 32-bit down counter, a programmable load register, interrupt generation logic, and a locking register.

The Watchdog Timer can be configured to generate an interrupt to the controller on its first time-out, and to generate a reset signal on its second time-out. Once the Watchdog Timer has been configured, the lock register can be written to prevent the timer configuration from being inadvertently altered.

1.4.6 Memory Peripherals

The LM3S6916 controller offers both single-cycle SRAM and single-cycle Flash memory.

1.4.6.1 SRAM (see page 132)

The LM3S6916 static random access memory (SRAM) controller supports 64 KB SRAM. The internal SRAM of the Stellaris® devices is located at offset 0x0000.0000 of the device memory map. To

reduce the number of time-consuming read-modify-write (RMW) operations, ARM has introduced *bit-banding* technology in the new Cortex-M3 processor. With a bit-band-enabled processor, certain regions in the memory map (SRAM and peripheral space) can use address aliases to access individual bits in a single, atomic operation.

1.4.6.2 Flash (see page 133)

The LM3S6916 Flash controller supports 256 KB of flash memory. The flash is organized as a set of 1-KB blocks that can be individually erased. Erasing a block causes the entire contents of the block to be reset to all 1s. These blocks are paired into a set of 2-KB blocks that can be individually protected. The blocks can be marked as read-only or execute-only, providing different levels of code protection. Read-only blocks cannot be erased or programmed, protecting the contents of those blocks from being modified. Execute-only blocks cannot be erased or programmed, and can only be read by the controller instruction fetch mechanism, protecting the contents of those blocks from being read by either the controller or by a debugger.

1.4.7 Additional Features

1.4.7.1 Memory Map (see page 40)

A memory map lists the location of instructions and data in memory. The memory map for the LM3S6916 controller can be found in “Memory Map” on page 40. Register addresses are given as a hexadecimal increment, relative to the module's base address as shown in the memory map.

The *ARM® Cortex™-M3 Technical Reference Manual* provides further information on the memory map.

1.4.7.2 JTAG TAP Controller (see page 44)

The Joint Test Action Group (JTAG) port provides a standardized serial interface for controlling the Test Access Port (TAP) and associated test logic. The TAP, JTAG instruction register, and JTAG data registers can be used to test the interconnects of assembled printed circuit boards, obtain manufacturing information on the components, and observe and/or control the inputs and outputs of the controller during normal operation. The JTAG port provides a high degree of testability and chip-level access at a low cost.

The JTAG port is comprised of the standard five pins: $\overline{\text{TRST}}$, TCK, TMS, TDI, and TDO. Data is transmitted serially into the controller on TDI and out of the controller on TDO. The interpretation of this data is dependent on the current state of the TAP controller. For detailed information on the operation of the JTAG port and TAP controller, please refer to the *IEEE Standard 1149.1-Test Access Port and Boundary-Scan Architecture*.

The Luminary Micro JTAG controller works with the ARM JTAG controller built into the Cortex-M3 core. This is implemented by multiplexing the TDO outputs from both JTAG controllers. ARM JTAG instructions select the ARM TDO output while Luminary Micro JTAG instructions select the Luminary Micro TDO outputs. The multiplexer is controlled by the Luminary Micro JTAG controller, which has comprehensive programming for the ARM, Luminary Micro, and unimplemented JTAG instructions.

1.4.7.3 System Control and Clocks (see page 55)

System control determines the overall operation of the device. It provides information about the device, controls the clocking of the device and individual peripherals, and handles reset detection and reporting.

1.4.7.4 Hibernation Module (see page 113)

The Hibernation module provides logic to switch power off to the main processor and peripherals, and to wake on external or time-based events. The Hibernation module includes power-sequencing logic, a real-time clock with a pair of match registers, low-battery detection circuitry, and interrupt signalling to the processor. It also includes 64 32-bit words of non-volatile memory that can be used for saving state during hibernation.

1.4.8 Hardware Details

Details on the pins and package can be found in the following sections:

- “Pin Diagram” on page 480
- “Signal Tables” on page 481
- “Operating Characteristics” on page 494
- “Electrical Characteristics” on page 495
- “Package Information” on page 510

2 ARM Cortex-M3 Processor Core

The ARM Cortex-M3 processor provides the core for a high-performance, low-cost platform that meets the needs of minimal memory implementation, reduced pin count, and low power consumption, while delivering outstanding computational performance and exceptional system response to interrupts. Features include:

- Compact core.
- Thumb-2 instruction set, delivering the high-performance expected of an ARM core in the memory size usually associated with 8- and 16-bit devices; typically in the range of a few kilobytes of memory for microcontroller class applications.
- Rapid application execution through Harvard architecture characterized by separate buses for instruction and data.
- Exceptional interrupt handling, by implementing the register manipulations required for handling an interrupt in hardware.
- Memory protection unit (MPU) to provide a privileged mode of operation for complex applications.
- Migration from the ARM7™ processor family for better performance and power efficiency.
- Full-featured debug solution with a:
 - Serial Wire JTAG Debug Port (SWJ-DP)
 - Flash Patch and Breakpoint (FPB) unit for implementing breakpoints
 - Data Watchpoint and Trigger (DWT) unit for implementing watchpoints, trigger resources, and system profiling
 - Instrumentation Trace Macrocell (ITM) for support of printf style debugging
 - Trace Port Interface Unit (TPIU) for bridging to a Trace Port Analyzer

The Stellaris® family of microcontrollers builds on this core to bring high-performance 32-bit computing to cost-sensitive embedded microcontroller applications, such as factory automation and control, industrial control power devices, building and home automation, and stepper motors.

For more information on the ARM Cortex-M3 processor core, see the *ARM® Cortex™-M3 Technical Reference Manual*. For information on SWJ-DP, see the *ARM® CoreSight Technical Reference Manual*.

2.1 Block Diagram

Figure 2-1. CPU Block Diagram

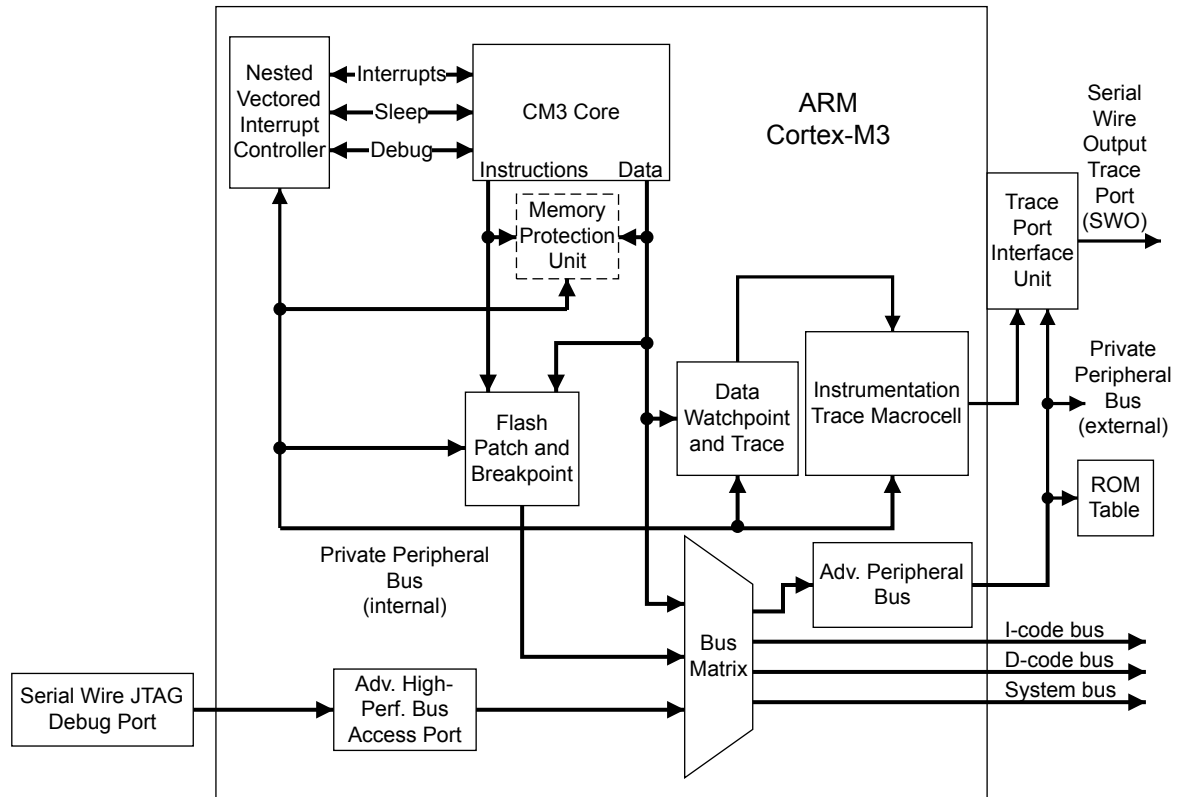

2.2 Functional Description

Important: The *ARM® Cortex™-M3 Technical Reference Manual* describes all the features of an ARM Cortex-M3 in detail. However, these features differ based on the implementation. This section describes the Stellaris® implementation.

Luminary Micro has implemented the ARM Cortex-M3 core as shown in Figure 2-1 on page 35. As noted in the *ARM® Cortex™-M3 Technical Reference Manual*, several Cortex-M3 components are flexible in their implementation: SW/JTAG-DP, ETM, TPIU, the ROM table, the MPU, and the Nested Vectored Interrupt Controller (NVIC). Each of these is addressed in the sections that follow.

2.2.1 Serial Wire and JTAG Debug

Luminary Micro has replaced the ARM SW-DP and JTAG-DP with the ARM CoreSight™-compliant Serial Wire JTAG Debug Port (SWJ-DP) interface. This means Chapter 12, “Debug Port,” of the *ARM® Cortex™-M3 Technical Reference Manual* does not apply to Stellaris® devices.

The SWJ-DP interface combines the SWD and JTAG debug ports into one module. See the *CoreSight™ Design Kit Technical Reference Manual* for details on SWJ-DP.

2.2.2 Embedded Trace Macrocell (ETM)

ETM was not implemented in the Stellaris[®] devices. This means Chapters 15 and 16 of the *ARM[®] Cortex[™]-M3 Technical Reference Manual* can be ignored.

2.2.3 Trace Port Interface Unit (TPIU)

The TPIU acts as a bridge between the Cortex-M3 trace data from the ITM, and an off-chip Trace Port Analyzer. The Stellaris[®] devices have implemented TPIU as shown in Figure 2-2 on page 36. This is similar to the non-ETM version described in the *ARM[®] Cortex[™]-M3 Technical Reference Manual*, however, SWJ-DP only provides SWV output for the TPIU.

Figure 2-2. TPIU Block Diagram

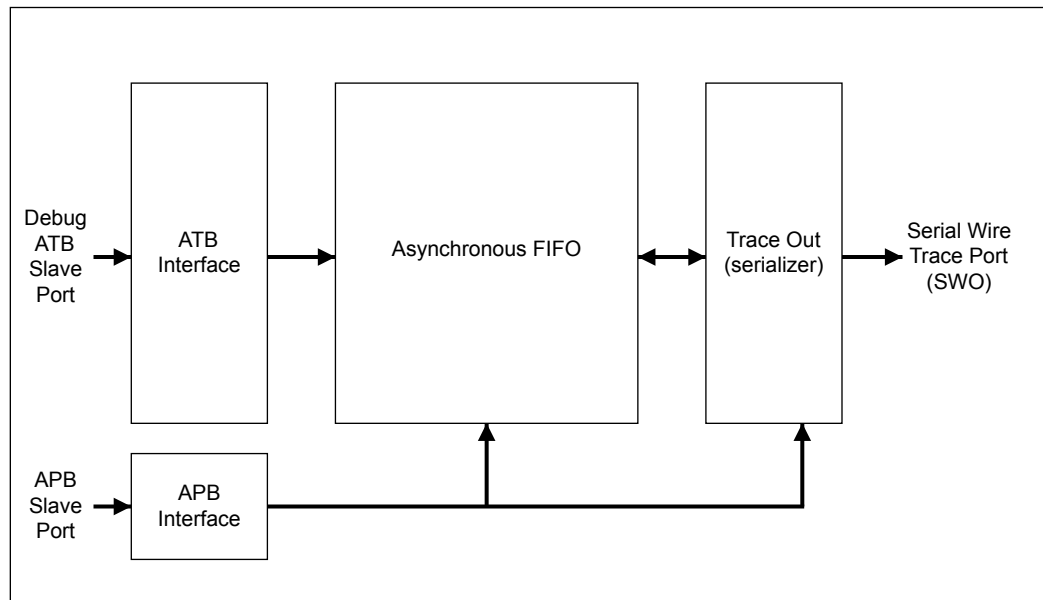

2.2.4 ROM Table

The default ROM table was implemented as described in the *ARM[®] Cortex[™]-M3 Technical Reference Manual*.

2.2.5 Memory Protection Unit (MPU)

The Memory Protection Unit (MPU) is included on the LM3S6916 controller and supports the standard ARMv7 Protected Memory System Architecture (PMSA) model. The MPU provides full support for protection regions, overlapping protection regions, access permissions, and exporting memory attributes to the system.

2.2.6 Nested Vectored Interrupt Controller (NVIC)

The Nested Vectored Interrupt Controller (NVIC):

- Facilitates low-latency exception and interrupt handling
- Controls power management
- Implements system control registers

The NVIC supports up to 240 dynamically reprioritizable interrupts each with up to 256 levels of priority. The NVIC and the processor core interface are closely coupled, which enables low latency interrupt processing and efficient processing of late arriving interrupts. The NVIC maintains knowledge of the stacked (nested) interrupts to enable tail-chaining of interrupts.

You can only fully access the NVIC from privileged mode, but you can pend interrupts in user-mode if you enable the Configuration Control Register (see the ARM® Cortex™-M3 Technical Reference Manual). Any other user-mode access causes a bus fault.

All NVIC registers are accessible using byte, halfword, and word unless otherwise stated.

All NVIC registers and system debug registers are little endian regardless of the endianness state of the processor.

2.2.6.1 Interrupts

The *ARM® Cortex™-M3 Technical Reference Manual* describes the maximum number of interrupts and interrupt priorities. The LM3S6916 microcontroller supports 31 interrupts with eight priority levels.

2.2.6.2 System Timer (SysTick)

Cortex-M3 includes an integrated system timer, SysTick. SysTick provides a simple, 24-bit clear-on-write, decrementing, wrap-on-zero counter with a flexible control mechanism. The counter can be used in several different ways, for example:

- An RTOS tick timer which fires at a programmable rate (for example, 100 Hz) and invokes a SysTick routine.
- A high-speed alarm timer using the system clock.
- A variable rate alarm or signal timer—the duration is range-dependent on the reference clock used and the dynamic range of the counter.
- A simple counter. Software can use this to measure time to completion and time used.
- An internal clock source control based on missing/meeting durations. The COUNTFLAG bit-field in the control and status register can be used to determine if an action completed within a set duration, as part of a dynamic clock management control loop.

Functional Description

The timer consists of three registers:

- A control and status counter to configure its clock, enable the counter, enable the SysTick interrupt, and determine counter status.
- The reload value for the counter, used to provide the counter's wrap value.
- The current value of the counter.

A fourth register, the SysTick Calibration Value Register, is not implemented in the Stellaris® devices.

When enabled, the timer counts down from the reload value to zero, reloads (wraps) to the value in the SysTick Reload Value register on the next clock edge, then decrements on subsequent clocks. Writing a value of zero to the Reload Value register disables the counter on the next wrap. When the counter reaches zero, the COUNTFLAG status bit is set. The COUNTFLAG bit clears on reads.

Writing to the Current Value register clears the register and the COUNTFLAG status bit. The write does not trigger the SysTick exception logic. On a read, the current value is the value of the register at the time the register is accessed.

If the core is in debug state (halted), the counter will not decrement. The timer is clocked with respect to a reference clock. The reference clock can be the core clock or an external clock source.

SysTick Control and Status Register

Use the SysTick Control and Status Register to enable the SysTick features. The reset is 0x0000.0000.

Bit/Field	Name	Type	Reset	Description
31:17	reserved	RO	0	Software should not rely on the value of a reserved bit. To provide compatibility with future products, the value of a reserved bit should be preserved across a read-modify-write operation.
16	COUNTFLAG	R/W	0	Returns 1 if timer counted to 0 since last time this was read. Clears on read by application. If read by the debugger using the DAP, this bit is cleared on read-only if the MasterType bit in the AHB-AP Control Register is set to 0. Otherwise, the COUNTFLAG bit is not changed by the debugger read.
15:3	reserved	RO	0	Software should not rely on the value of a reserved bit. To provide compatibility with future products, the value of a reserved bit should be preserved across a read-modify-write operation.
2	CLKSOURCE	R/W	0	0 = external reference clock. (Not implemented for Stellaris microcontrollers.) 1 = core clock. If no reference clock is provided, it is held at 1 and so gives the same time as the core clock. The core clock must be at least 2.5 times faster than the reference clock. If it is not, the count values are unpredictable.
1	TICKINT	R/W	0	1 = counting down to 0 pends the SysTick handler. 0 = counting down to 0 does not pend the SysTick handler. Software can use the COUNTFLAG to determine if ever counted to 0.
0	ENABLE	R/W	0	1 = counter operates in a multi-shot way. That is, counter loads with the Reload value and then begins counting down. On reaching 0, it sets the COUNTFLAG to 1 and optionally pends the SysTick handler, based on TICKINT. It then loads the Reload value again, and begins counting. 0 = counter disabled.

SysTick Reload Value Register

Use the SysTick Reload Value Register to specify the start value to load into the current value register when the counter reaches 0. It can be any value between 1 and 0x00FF.FFFF. A start value of 0 is possible, but has no effect because the SysTick interrupt and COUNTFLAG are activated when counting from 1 to 0.

Therefore, as a multi-shot timer, repeated over and over, it fires every N+1 clock pulse, where N is any value from 1 to 0x00FF.FFFF. So, if the tick interrupt is required every 100 clock pulses, 99 must be written into the RELOAD. If a new value is written on each tick interrupt, so treated as single shot, then the actual count down must be written. For example, if a tick is next required after 400 clock pulses, 400 must be written into the RELOAD.

Bit/Field	Name	Type	Reset	Description
31:24	reserved	RO	0	Software should not rely on the value of a reserved bit. To provide compatibility with future products, the value of a reserved bit should be preserved across a read-modify-write operation.

Bit/Field	Name	Type	Reset	Description
23:0	RELOAD	W1C	-	Value to load into the SysTick Current Value Register when the counter reaches 0.

SysTick Current Value Register

Use the SysTick Current Value Register to find the current value in the register.

Bit/Field	Name	Type	Reset	Description
31:24	reserved	RO	0	Software should not rely on the value of a reserved bit. To provide compatibility with future products, the value of a reserved bit should be preserved across a read-modify-write operation.
23:0	CURRENT	W1C	-	Current value at the time the register is accessed. No read-modify-write protection is provided, so change with care. This register is write-clear. Writing to it with any value clears the register to 0. Clearing this register also clears the COUNTFLAG bit of the SysTick Control and Status Register.

SysTick Calibration Value Register

The SysTick Calibration Value register is not implemented.

3 Memory Map

The memory map for the LM3S6916 controller is provided in Table 3-1 on page 40.

In this manual, register addresses are given as a hexadecimal increment, relative to the module's base address as shown in the memory map. See also Chapter 4, "Memory Map" in the *ARM® Cortex™-M3 Technical Reference Manual*.

Important: In Table 3-1 on page 40, addresses not listed are reserved.

Table 3-1. Memory Map^a

Start	End	Description	For details on registers, see page ...
Memory			
0x0000.0000	0x0003.FFFF	On-chip flash ^b	136
0x2000.0000	0x2000.FFFF	Bit-banded on-chip SRAM ^c	136
0x2010.0000	0x21FF.FFFF	Reserved non-bit-banded SRAM space	-
0x2200.0000	0x23FF.FFFF	Bit-band alias of 0x2000.0000 through 0x200F.FFFF	132
0x2400.0000	0x3FFF.FFFF	Reserved non-bit-banded SRAM space	-
FiRM Peripherals			
0x4000.0000	0x4000.0FFF	Watchdog timer	235
0x4000.4000	0x4000.4FFF	GPIO Port A	162
0x4000.5000	0x4000.5FFF	GPIO Port B	162
0x4000.6000	0x4000.6FFF	GPIO Port C	162
0x4000.7000	0x4000.7FFF	GPIO Port D	162
0x4000.8000	0x4000.8FFF	SSI0	340
0x4000.C000	0x4000.CFFF	UART0	295
0x4000.D000	0x4000.DFFF	UART1	295
0x4000.E000	0x4000.EFFF	UART2	295
Peripherals			
0x4002.0000	0x4002.07FF	I2C Master 0	379
0x4002.0800	0x4002.0FFF	I2C Slave 0	392
0x4002.4000	0x4002.4FFF	GPIO Port E	162
0x4002.5000	0x4002.5FFF	GPIO Port F	162
0x4002.6000	0x4002.6FFF	GPIO Port G	162
0x4002.8000	0x4002.8FFF	PWM	451
0x4003.0000	0x4003.0FFF	Timer0	208
0x4003.1000	0x4003.1FFF	Timer1	208
0x4003.2000	0x4003.2FFF	Timer2	208
0x4003.3000	0x4003.3FFF	Timer3	208
0x4003.8000	0x4003.8FFF	ADC	261
0x4004.8000	0x4004.8FFF	Ethernet Controller	409
0x400F.C000	0x400F.CFFF	Hibernation Module	119
0x400F.D000	0x400F.DFFF	Flash control	136

Start	End	Description	For details on registers, see page ...
0x400F.E000	0x400F.EFFF	System control	62
0x4200.0000	0x43FF.FFFF	Bit-banded alias of 0x4000.0000 through 0x400F.FFFF	-
Private Peripheral Bus			
0xE000.0000	0xE000.0FFF	Instrumentation Trace Macrocell (ITM)	ARM® Cortex™-M3 Technical Reference Manual
0xE000.1000	0xE000.1FFF	Data Watchpoint and Trace (DWT)	
0xE000.2000	0xE000.2FFF	Flash Patch and Breakpoint (FPB)	
0xE000.3000	0xE000.DFFF	Reserved	
0xE000.E000	0xE000.EFFF	Nested Vectored Interrupt Controller (NVIC)	
0xE000.F000	0xE003.FFFF	Reserved	
0xE004.0000	0xE004.0FFF	Trace Port Interface Unit (TPIU)	
0xE004.1000	0xE004.1FFF	Reserved	-
0xE004.2000	0xE00F.FFFF	Reserved	-
0xE010.0000	0xFFFF.FFFF	Reserved for vendor peripherals	-

- a. All reserved space returns a bus fault when read or written.
b. The unavailable flash will bus fault throughout this range.
c. The unavailable SRAM will bus fault throughout this range.

4 Interrupts

The ARM Cortex-M3 processor and the Nested Vectored Interrupt Controller (NVIC) prioritize and handle all exceptions. All exceptions are handled in Handler Mode. The processor state is automatically stored to the stack on an exception, and automatically restored from the stack at the end of the Interrupt Service Routine (ISR). The vector is fetched in parallel to the state saving, which enables efficient interrupt entry. The processor supports tail-chaining, which enables back-to-back interrupts to be performed without the overhead of state saving and restoration.

Table 4-1 on page 42 lists all the exceptions. Software can set eight priority levels on seven of these exceptions (system handlers) as well as on 31 interrupts (listed in Table 4-2 on page 43).

Priorities on the system handlers are set with the NVIC System Handler Priority registers. Interrupts are enabled through the NVIC Interrupt Set Enable register and prioritized with the NVIC Interrupt Priority registers. You can also group priorities by splitting priority levels into pre-emption priorities and subpriorities. All the interrupt registers are described in Chapter 8, “Nested Vectored Interrupt Controller” in the *ARM® Cortex™-M3 Technical Reference Manual*.

Internally, the highest user-settable priority (0) is treated as fourth priority, after a Reset, NMI, and a Hard Fault. Note that 0 is the default priority for all the settable priorities.

If you assign the same priority level to two or more interrupts, their hardware priority (the lower the position number) determines the order in which the processor activates them. For example, if both GPIO Port A and GPIO Port B are priority level 1, then GPIO Port A has higher priority.

See Chapter 5, “Exceptions” and Chapter 8, “Nested Vectored Interrupt Controller” in the *ARM® Cortex™-M3 Technical Reference Manual* for more information on exceptions and interrupts.

Note: In Table 4-2 on page 43 interrupts not listed are reserved.

Table 4-1. Exception Types

Exception Type	Position	Priority ^a	Description
-	0	-	Stack top is loaded from first entry of vector table on reset.
Reset	1	-3 (highest)	Invoked on power up and warm reset. On first instruction, drops to lowest priority (and then is called the base level of activation). This is asynchronous.
Non-Maskable Interrupt (NMI)	2	-2	Cannot be stopped or preempted by any exception but reset. This is asynchronous. An NMI is only producible by software, using the NVIC Interrupt Control State register.
Hard Fault	3	-1	All classes of Fault, when the fault cannot activate due to priority or the configurable fault handler has been disabled. This is synchronous.
Memory Management	4	settable	MPU mismatch, including access violation and no match. This is synchronous. The priority of this exception can be changed.
Bus Fault	5	settable	Pre-fetch fault, memory access fault, and other address/memory related faults. This is synchronous when precise and asynchronous when imprecise. You can enable or disable this fault.
Usage Fault	6	settable	Usage fault, such as undefined instruction executed or illegal state transition attempt. This is synchronous.
-	7-10	-	Reserved.
SVCcall	11	settable	System service call with SVC instruction. This is synchronous.

Exception Type	Position	Priority ^a	Description
Debug Monitor	12	settable	Debug monitor (when not halting). This is synchronous, but only active when enabled. It does not activate if lower priority than the current activation.
-	13	-	Reserved.
PendSV	14	settable	Pendable request for system service. This is asynchronous and only pended by software.
SysTick	15	settable	System tick timer has fired. This is asynchronous.
Interrupts	16 and above	settable	Asserted from outside the ARM Cortex-M3 core and fed through the NVIC (prioritized). These are all asynchronous. Table 4-2 on page 43 lists the interrupts on the LM3S6916 controller.

a. 0 is the default priority for all the settable priorities.

Table 4-2. Interrupts

Interrupt (Bit in Interrupt Registers)	Description
0	GPIO Port A
1	GPIO Port B
2	GPIO Port C
3	GPIO Port D
4	GPIO Port E
5	UART0
6	UART1
7	SSI0
8	I2C0
9	PWM Fault
10	PWM Generator 0
14	ADC Sequence 0
15	ADC Sequence 1
16	ADC Sequence 2
17	ADC Sequence 3
18	Watchdog timer
19	Timer0 A
20	Timer0 B
21	Timer1 A
22	Timer1 B
23	Timer2 A
24	Timer2 B
28	System Control
29	Flash Control
30	GPIO Port F
31	GPIO Port G
33	UART2
35	Timer3 A
36	Timer3 B
42	Ethernet Controller
43	Hibernation Module

5 JTAG Interface

The Joint Test Action Group (JTAG) port is an IEEE standard that defines a Test Access Port and Boundary Scan Architecture for digital integrated circuits and provides a standardized serial interface for controlling the associated test logic. The TAP, Instruction Register (IR), and Data Registers (DR) can be used to test the interconnections of assembled printed circuit boards and obtain manufacturing information on the components. The JTAG Port also provides a means of accessing and controlling design-for-test features such as I/O pin observation and control, scan testing, and debugging.

The JTAG port is comprised of the standard five pins: $\overline{\text{TRST}}$, TCK, TMS, TDI, and TDO. Data is transmitted serially into the controller on TDI and out of the controller on TDO. The interpretation of this data is dependent on the current state of the TAP controller. For detailed information on the operation of the JTAG port and TAP controller, please refer to the *IEEE Standard 1149.1-Test Access Port and Boundary-Scan Architecture*.

The Luminary Micro JTAG controller works with the ARM JTAG controller built into the Cortex-M3 core. This is implemented by multiplexing the TDO outputs from both JTAG controllers. ARM JTAG instructions select the ARM TDO output while Luminary Micro JTAG instructions select the Luminary Micro TDO outputs. The multiplexer is controlled by the Luminary Micro JTAG controller, which has comprehensive programming for the ARM, Luminary Micro, and unimplemented JTAG instructions.

The JTAG module has the following features:

- IEEE 1149.1-1990 compatible Test Access Port (TAP) controller
- Four-bit Instruction Register (IR) chain for storing JTAG instructions
- IEEE standard instructions:
 - BYPASS instruction
 - IDCODE instruction
 - SAMPLE/PRELOAD instruction
 - EXTEST instruction
 - INTEST instruction
- ARM additional instructions:
 - APACC instruction
 - DPACC instruction
 - ABORT instruction
- Integrated ARM Serial Wire Debug (SWD)

See the *ARM® Cortex™-M3 Technical Reference Manual* for more information on the ARM JTAG controller.

5.1 Block Diagram

Figure 5-1. JTAG Module Block Diagram

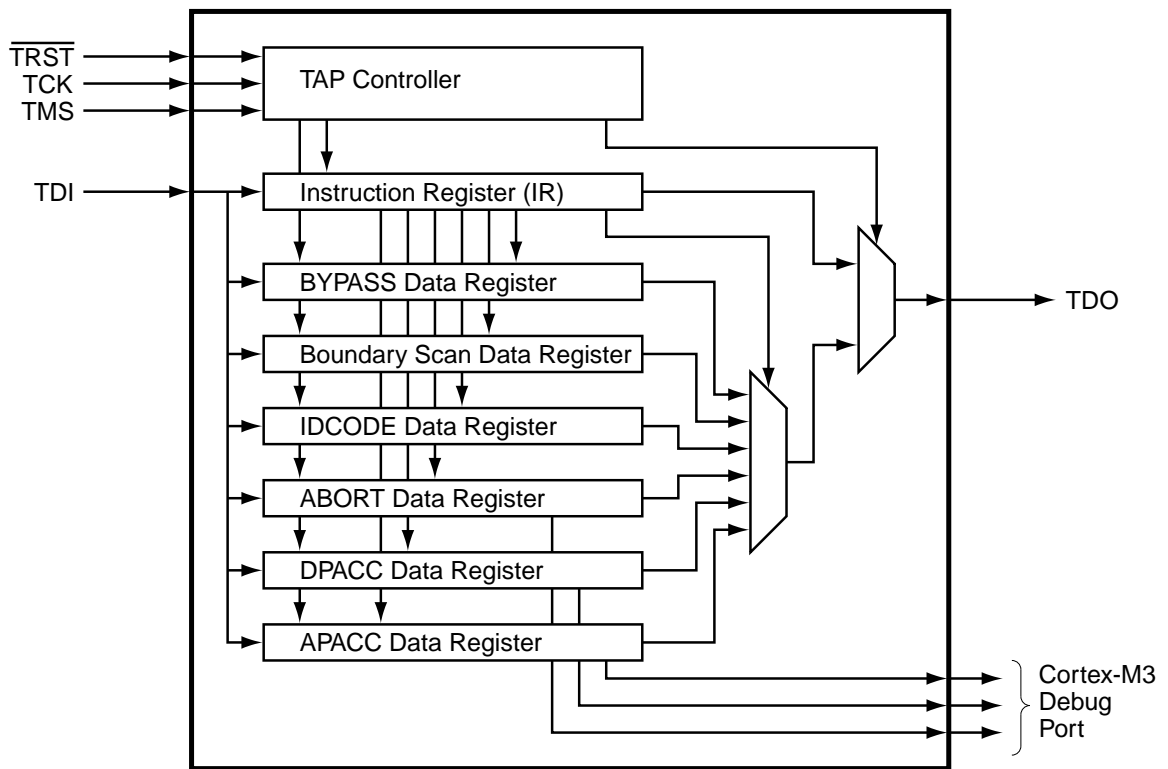

5.2 Functional Description

A high-level conceptual drawing of the JTAG module is shown in Figure 5-1 on page 45. The JTAG module is composed of the Test Access Port (TAP) controller and serial shift chains with parallel update registers. The TAP controller is a simple state machine controlled by the $\overline{\text{TRST}}$, TCK and TMS inputs. The current state of the TAP controller depends on the current value of $\overline{\text{TRST}}$ and the sequence of values captured on TMS at the rising edge of TCK . The TAP controller determines when the serial shift chains capture new data, shift data from TDI towards TDO , and update the parallel load registers. The current state of the TAP controller also determines whether the Instruction Register (IR) chain or one of the Data Register (DR) chains is being accessed.

The serial shift chains with parallel load registers are comprised of a single Instruction Register (IR) chain and multiple Data Register (DR) chains. The current instruction loaded in the parallel load register determines which DR chain is captured, shifted, or updated during the sequencing of the TAP controller.

Some instructions, like EXTEST and INTEST , operate on data currently in a DR chain and do not capture, shift, or update any of the chains. Instructions that are not implemented decode to the BYPASS instruction to ensure that the serial path between TDI and TDO is always connected (see Table 5-2 on page 51 for a list of implemented instructions).

See “JTAG and Boundary Scan” on page 505 for JTAG timing diagrams.

5.2.1 JTAG Interface Pins

The JTAG interface consists of five standard pins: $\overline{\text{TRST}}$, TCK, TMS, TDI, and TDO. These pins and their associated reset state are given in Table 5-1 on page 46. Detailed information on each pin follows.

Table 5-1. JTAG Port Pins Reset State

Pin Name	Data Direction	Internal Pull-Up	Internal Pull-Down	Drive Strength	Drive Value
$\overline{\text{TRST}}$	Input	Enabled	Disabled	N/A	N/A
TCK	Input	Enabled	Disabled	N/A	N/A
TMS	Input	Enabled	Disabled	N/A	N/A
TDI	Input	Enabled	Disabled	N/A	N/A
TDO	Output	Enabled	Disabled	2-mA driver	High-Z

5.2.1.1 Test Reset Input ($\overline{\text{TRST}}$)

The $\overline{\text{TRST}}$ pin is an asynchronous active Low input signal for initializing and resetting the JTAG TAP controller and associated JTAG circuitry. When $\overline{\text{TRST}}$ is asserted, the TAP controller resets to the Test-Logic-Reset state and remains there while $\overline{\text{TRST}}$ is asserted. When the TAP controller enters the Test-Logic-Reset state, the JTAG Instruction Register (IR) resets to the default instruction, IDCODE.

By default, the internal pull-up resistor on the $\overline{\text{TRST}}$ pin is enabled after reset. Changes to the pull-up resistor settings on GPIO Port B should ensure that the internal pull-up resistor remains enabled on PB7/ $\overline{\text{TRST}}$; otherwise JTAG communication could be lost.

5.2.1.2 Test Clock Input (TCK)

The TCK pin is the clock for the JTAG module. This clock is provided so the test logic can operate independently of any other system clocks. In addition, it ensures that multiple JTAG TAP controllers that are daisy-chained together can synchronously communicate serial test data between components. During normal operation, TCK is driven by a free-running clock with a nominal 50% duty cycle. When necessary, TCK can be stopped at 0 or 1 for extended periods of time. While TCK is stopped at 0 or 1, the state of the TAP controller does not change and data in the JTAG Instruction and Data Registers is not lost.

By default, the internal pull-up resistor on the TCK pin is enabled after reset. This assures that no clocking occurs if the pin is not driven from an external source. The internal pull-up and pull-down resistors can be turned off to save internal power as long as the TCK pin is constantly being driven by an external source.

5.2.1.3 Test Mode Select (TMS)

The TMS pin selects the next state of the JTAG TAP controller. TMS is sampled on the rising edge of TCK. Depending on the current TAP state and the sampled value of TMS, the next state is entered. Because the TMS pin is sampled on the rising edge of TCK, the *IEEE Standard 1149.1* expects the value on TMS to change on the falling edge of TCK.

Holding TMS high for five consecutive TCK cycles drives the TAP controller state machine to the Test-Logic-Reset state. When the TAP controller enters the Test-Logic-Reset state, the JTAG Instruction Register (IR) resets to the default instruction, IDCODE. Therefore, this sequence can be used as a reset mechanism, similar to asserting $\overline{\text{TRST}}$. The JTAG Test Access Port state machine can be seen in its entirety in Figure 5-2 on page 48.

By default, the internal pull-up resistor on the TMS pin is enabled after reset. Changes to the pull-up resistor settings on GPIO Port C should ensure that the internal pull-up resistor remains enabled on PC1/TMS; otherwise JTAG communication could be lost.

5.2.1.4 Test Data Input (TDI)

The TDI pin provides a stream of serial information to the IR chain and the DR chains. TDI is sampled on the rising edge of TCK and, depending on the current TAP state and the current instruction, presents this data to the proper shift register chain. Because the TDI pin is sampled on the rising edge of TCK, the *IEEE Standard 1149.1* expects the value on TDI to change on the falling edge of TCK.

By default, the internal pull-up resistor on the TDI pin is enabled after reset. Changes to the pull-up resistor settings on GPIO Port C should ensure that the internal pull-up resistor remains enabled on PC2/TDI; otherwise JTAG communication could be lost.

5.2.1.5 Test Data Output (TDO)

The TDO pin provides an output stream of serial information from the IR chain or the DR chains. The value of TDO depends on the current TAP state, the current instruction, and the data in the chain being accessed. In order to save power when the JTAG port is not being used, the TDO pin is placed in an inactive drive state when not actively shifting out data. Because TDO can be connected to the TDI of another controller in a daisy-chain configuration, the *IEEE Standard 1149.1* expects the value on TDO to change on the falling edge of TCK.

By default, the internal pull-up resistor on the TDO pin is enabled after reset. This assures that the pin remains at a constant logic level when the JTAG port is not being used. The internal pull-up and pull-down resistors can be turned off to save internal power if a High-Z output value is acceptable during certain TAP controller states.

5.2.2 JTAG TAP Controller

The JTAG TAP controller state machine is shown in Figure 5-2 on page 48. The TAP controller state machine is reset to the Test-Logic-Reset state on the assertion of a Power-On-Reset (POR) or the assertion of $\overline{\text{TRST}}$. Asserting the correct sequence on the TMS pin allows the JTAG module to shift in new instructions, shift in data, or idle during extended testing sequences. For detailed information on the function of the TAP controller and the operations that occur in each state, please refer to *IEEE Standard 1149.1*.

Figure 5-2. Test Access Port State Machine

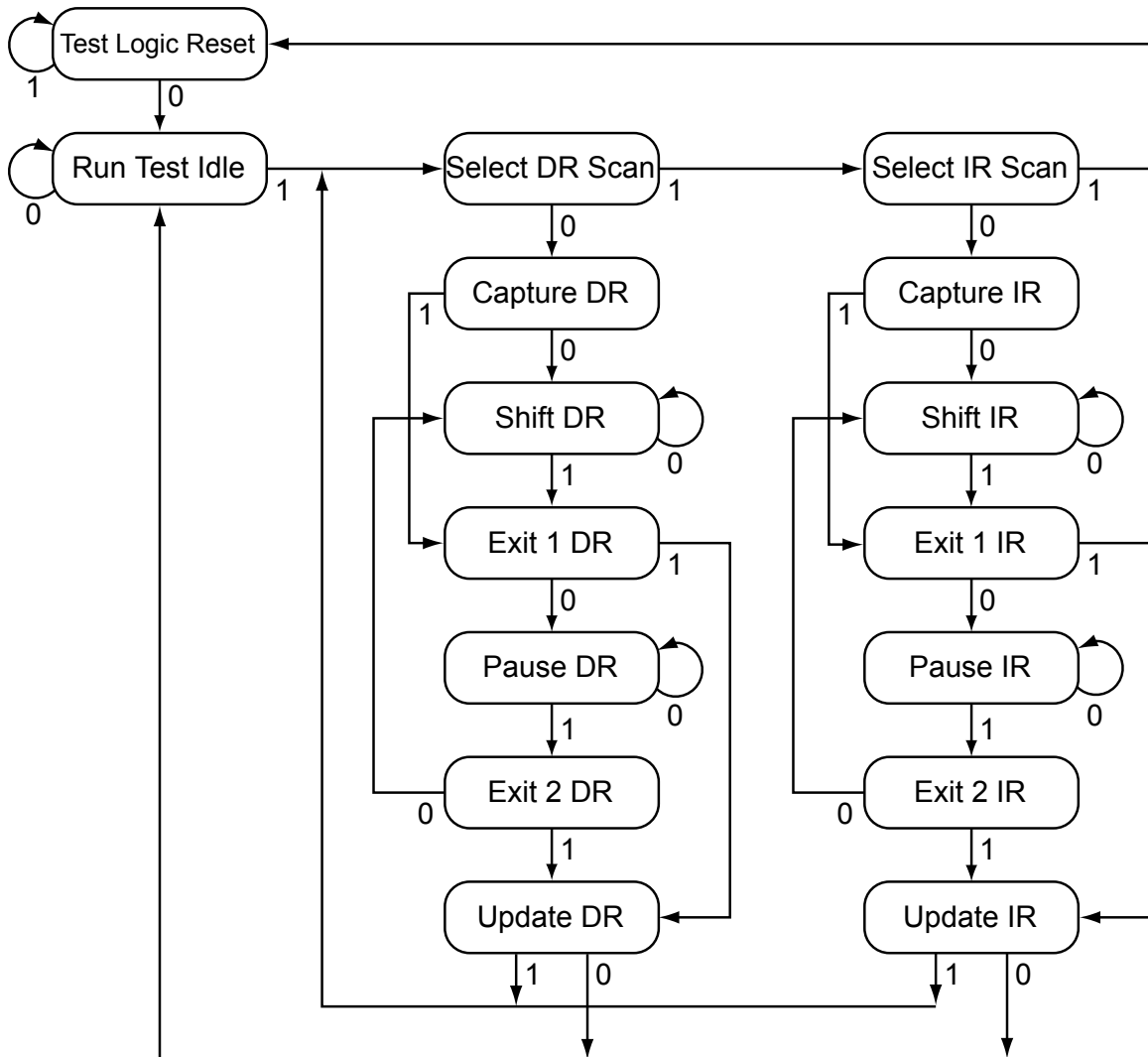

5.2.3 Shift Registers

The Shift Registers consist of a serial shift register chain and a parallel load register. The serial shift register chain samples specific information during the TAP controller's CAPTURE states and allows this information to be shifted out of TDO during the TAP controller's SHIFT states. While the sampled data is being shifted out of the chain on TDO, new data is being shifted into the serial shift register on TDI. This new data is stored in the parallel load register during the TAP controller's UPDATE states. Each of the shift registers is discussed in detail in "Register Descriptions" on page 51.

5.2.4 Operational Considerations

There are certain operational considerations when using the JTAG module. Because the JTAG pins can be programmed to be GPIOs, board configuration and reset conditions on these pins must be considered. In addition, because the JTAG module has integrated ARM Serial Wire Debug, the method for switching between these two operational modes is described below.

5.2.4.1 GPIO Functionality

When the controller is reset with either a POR or $\overline{\text{RST}}$, the JTAG/SWD port pins default to their JTAG/SWD configurations. The default configuration includes enabling digital functionality (setting **GPIO DEN** to 1), enabling the pull-up resistors (setting **GPIO PUR** to 1), and enabling the alternate hardware function (setting **GPIO AFSEL** to 1) for the PB7 and $\text{PC}[3:0]$ JTAG/SWD pins.

It is possible for software to configure these pins as GPIOs after reset by writing 0s to PB7 and $\text{PC}[3:0]$ in the **GPIO AFSEL** register. If the user does not require the JTAG/SWD port for debugging or board-level testing, this provides five more GPIOs for use in the design.

Caution – If the JTAG pins are used as GPIOs in a design, PB7 and PC2 cannot have external pull-down resistors connected to both of them at the same time. If both pins are pulled Low during reset, the controller has unpredictable behavior. If this happens, remove one or both of the pull-down resistors, and apply $\overline{\text{RST}}$ or power-cycle the part.

In addition, it is possible to create a software sequence that prevents the debugger from connecting to the Stellaris[®] microcontroller. If the program code loaded into flash immediately changes the JTAG pins to their GPIO functionality, the debugger may not have enough time to connect and halt the controller before the JTAG pin functionality switches. This may lock the debugger out of the part. This can be avoided with a software routine that restores JTAG functionality based on an external or software trigger.

The commit control registers provide a layer of protection against accidental programming of critical hardware peripherals. Writes to protected bits of the **GPIO Alternate Function Select (GPIO AFSEL)** register (see page 172) are not committed to storage unless the **GPIO Lock (GPIO LOCK)** register (see page 182) has been unlocked and the appropriate bits of the **GPIO Commit (GPIO CR)** register (see page 183) have been set to 1.

Recovering a "Locked" Device

If software configures any of the JTAG/SWD pins as GPIO and loses the ability to communicate with the debugger, there is a debug sequence that can be used to recover the device. Performing a total of ten JTAG-to-SWD and SWD-to-JTAG switch sequences while holding the device in reset mass erases the flash memory. The sequence to recover the device is:

1. Assert and hold the $\overline{\text{RST}}$ signal.
2. Perform the JTAG-to-SWD switch sequence.
3. Perform the SWD-to-JTAG switch sequence.
4. Perform the JTAG-to-SWD switch sequence.
5. Perform the SWD-to-JTAG switch sequence.
6. Perform the JTAG-to-SWD switch sequence.
7. Perform the SWD-to-JTAG switch sequence.
8. Perform the JTAG-to-SWD switch sequence.
9. Perform the SWD-to-JTAG switch sequence.
10. Perform the JTAG-to-SWD switch sequence.
11. Perform the SWD-to-JTAG switch sequence.

12. Release the $\overline{\text{RST}}$ signal.

The JTAG-to-SWD and SWD-to-JTAG switch sequences are described in “ARM Serial Wire Debug (SWD)” on page 50. When performing switch sequences for the purpose of recovering the debug capabilities of the device, only steps 1 and 2 of the switch sequence need to be performed.

5.2.4.2 ARM Serial Wire Debug (SWD)

In order to seamlessly integrate the ARM Serial Wire Debug (SWD) functionality, a serial-wire debugger must be able to connect to the Cortex-M3 core without having to perform, or have any knowledge of, JTAG cycles. This is accomplished with a SWD preamble that is issued before the SWD session begins.

The preamble used to enable the SWD interface of the SWJ-DP module starts with the TAP controller in the Test-Logic-Reset state. From here, the preamble sequences the TAP controller through the following states: Run Test Idle, Select DR, Select IR, Test Logic Reset, Test Logic Reset, Run Test Idle, Run Test Idle, Select DR, Select IR, Test Logic Reset, Test Logic Reset, Run Test Idle, Run Test Idle, Select DR, Select IR, and Test Logic Reset states.

Stepping through this sequences of the TAP state machine enables the SWD interface and disables the JTAG interface. For more information on this operation and the SWD interface, see the *ARM® Cortex™-M3 Technical Reference Manual* and the *ARM® CoreSight Technical Reference Manual*.

Because this sequence is a valid series of JTAG operations that could be issued, the ARM JTAG TAP controller is not fully compliant to the *IEEE Standard 1149.1*. This is the only instance where the ARM JTAG TAP controller does not meet full compliance with the specification. Due to the low probability of this sequence occurring during normal operation of the TAP controller, it should not affect normal performance of the JTAG interface.

JTAG-to-SWD Switching

To switch the operating mode of the Debug Access Port (DAP) from JTAG to SWD mode, the external debug hardware must send a switch sequence to the device. The 16-bit switch sequence for switching to SWD mode is defined as b1110011110011110, transmitted LSB first. This can also be represented as 16'hE79E when transmitted LSB first. The complete switch sequence should consist of the following transactions on the TCK/SWCLK and TMS/SWDIO signals:

1. Send at least 50 TCK/SWCLK cycles with TMS/SWDIO set to 1. This ensures that both JTAG and SWD are in their reset/idle states.
2. Send the 16-bit JTAG-to-SWD switch sequence, 16'hE79E.
3. Send at least 50 TCK/SWCLK cycles with TMS/SWDIO set to 1. This ensures that if SWJ-DP was already in SWD mode, before sending the switch sequence, the SWD goes into the line reset state.

SWD-to-JTAG Switching

To switch the operating mode of the Debug Access Port (DAP) from SWD to JTAG mode, the external debug hardware must send a switch sequence to the device. The 16-bit switch sequence for switching to JTAG mode is defined as b1110011110011110, transmitted LSB first. This can also be represented as 16'hE73C when transmitted LSB first. The complete switch sequence should consist of the following transactions on the TCK/SWCLK and TMS/SWDIO signals:

1. Send at least 50 TCK/SWCLK cycles with TMS/SWDIO set to 1. This ensures that both JTAG and SWD are in their reset/idle states.

2. Send the 16-bit SWD-to-JTAG switch sequence, 16'hE73C.
3. Send at least 5 TCK/SWCLK cycles with TMS/SWDIO set to 1. This ensures that if SWJ-DP was already in JTAG mode, before sending the switch sequence, the JTAG goes into the Test Logic Reset state.

5.3 Initialization and Configuration

After a Power-On-Reset or an external reset ($\overline{\text{RST}}$), the JTAG pins are automatically configured for JTAG communication. No user-defined initialization or configuration is needed. However, if the user application changes these pins to their GPIO function, they must be configured back to their JTAG functionality before JTAG communication can be restored. This is done by enabling the five JTAG pins (PB7 and PC[3:0]) for their alternate function using the **GPIOAFSEL** register.

5.4 Register Descriptions

There are no APB-accessible registers in the JTAG TAP Controller or Shift Register chains. The registers within the JTAG controller are all accessed serially through the TAP Controller. The registers can be broken down into two main categories: Instruction Registers and Data Registers.

5.4.1 Instruction Register (IR)

The JTAG TAP Instruction Register (IR) is a four-bit serial scan chain with a parallel load register connected between the JTAG TDI and TDO pins. When the TAP Controller is placed in the correct states, bits can be shifted into the Instruction Register. Once these bits have been shifted into the chain and updated, they are interpreted as the current instruction. The decode of the Instruction Register bits is shown in Table 5-2 on page 51. A detailed explanation of each instruction, along with its associated Data Register, follows.

Table 5-2. JTAG Instruction Register Commands

IR[3:0]	Instruction	Description
0000	EXTEST	Drives the values preloaded into the Boundary Scan Chain by the SAMPLE/PRELOAD instruction onto the pads.
0001	INTEST	Drives the values preloaded into the Boundary Scan Chain by the SAMPLE/PRELOAD instruction into the controller.
0010	SAMPLE / PRELOAD	Captures the current I/O values and shifts the sampled values out of the Boundary Scan Chain while new preload data is shifted in.
1000	ABORT	Shifts data into the ARM Debug Port Abort Register.
1010	DPACC	Shifts data into and out of the ARM DP Access Register.
1011	APACC	Shifts data into and out of the ARM AC Access Register.
1110	IDCODE	Loads manufacturing information defined by the <i>IEEE Standard 1149.1</i> into the IDCODE chain and shifts it out.
1111	BYPASS	Connects TDI to TDO through a single Shift Register chain.
All Others	Reserved	Defaults to the BYPASS instruction to ensure that TDI is always connected to TDO.

5.4.1.1 EXTEST Instruction

The EXTEST instruction does not have an associated Data Register chain. The EXTEST instruction uses the data that has been preloaded into the Boundary Scan Data Register using the SAMPLE/PRELOAD instruction. When the EXTEST instruction is present in the Instruction Register, the preloaded data in the Boundary Scan Data Register associated with the outputs and output enables are used to drive the GPIO pads rather than the signals coming from the core. This allows

tests to be developed that drive known values out of the controller, which can be used to verify connectivity.

5.4.1.2 INTEST Instruction

The INTEST instruction does not have an associated Data Register chain. The INTEST instruction uses the data that has been preloaded into the Boundary Scan Data Register using the SAMPLE/PRELOAD instruction. When the INTEST instruction is present in the Instruction Register, the preloaded data in the Boundary Scan Data Register associated with the inputs are used to drive the signals going into the core rather than the signals coming from the GPIO pads. This allows tests to be developed that drive known values into the controller, which can be used for testing. It is important to note that although the $\overline{\text{RST}}$ input pin is on the Boundary Scan Data Register chain, it is only observable.

5.4.1.3 SAMPLE/PRELOAD Instruction

The SAMPLE/PRELOAD instruction connects the Boundary Scan Data Register chain between TDI and TDO . This instruction samples the current state of the pad pins for observation and preloads new test data. Each GPIO pad has an associated input, output, and output enable signal. When the TAP controller enters the Capture DR state during this instruction, the input, output, and output-enable signals to each of the GPIO pads are captured. These samples are serially shifted out of TDO while the TAP controller is in the Shift DR state and can be used for observation or comparison in various tests.

While these samples of the inputs, outputs, and output enables are being shifted out of the Boundary Scan Data Register, new data is being shifted into the Boundary Scan Data Register from TDI . Once the new data has been shifted into the Boundary Scan Data Register, the data is saved in the parallel load registers when the TAP controller enters the Update DR state. This update of the parallel load register preloads data into the Boundary Scan Data Register that is associated with each input, output, and output enable. This preloaded data can be used with the EXTEST and INTEST instructions to drive data into or out of the controller. Please see “Boundary Scan Data Register” on page 54 for more information.

5.4.1.4 ABORT Instruction

The ABORT instruction connects the associated ABORT Data Register chain between TDI and TDO . This instruction provides read and write access to the ABORT Register of the ARM Debug Access Port (DAP). Shifting the proper data into this Data Register clears various error bits or initiates a DAP abort of a previous request. Please see the “ABORT Data Register” on page 54 for more information.

5.4.1.5 DPACC Instruction

The DPACC instruction connects the associated DPACC Data Register chain between TDI and TDO . This instruction provides read and write access to the DPACC Register of the ARM Debug Access Port (DAP). Shifting the proper data into this register and reading the data output from this register allows read and write access to the ARM debug and status registers. Please see “DPACC Data Register” on page 54 for more information.

5.4.1.6 APACC Instruction

The APACC instruction connects the associated APACC Data Register chain between TDI and TDO . This instruction provides read and write access to the APACC Register of the ARM Debug Access Port (DAP). Shifting the proper data into this register and reading the data output from this register allows read and write access to internal components and buses through the Debug Port. Please see “APACC Data Register” on page 54 for more information.

5.4.1.7 IDCODE Instruction

The IDCODE instruction connects the associated IDCODE Data Register chain between TDI and TDO. This instruction provides information on the manufacturer, part number, and version of the ARM core. This information can be used by testing equipment and debuggers to automatically configure their input and output data streams. IDCODE is the default instruction that is loaded into the JTAG Instruction Register when a power-on-reset (POR) is asserted, $\overline{\text{TRST}}$ is asserted, or the Test-Logic-Reset state is entered. Please see “IDCODE Data Register” on page 53 for more information.

5.4.1.8 BYPASS Instruction

The BYPASS instruction connects the associated BYPASS Data Register chain between TDI and TDO. This instruction is used to create a minimum length serial path between the TDI and TDO ports. The BYPASS Data Register is a single-bit shift register. This instruction improves test efficiency by allowing components that are not needed for a specific test to be bypassed in the JTAG scan chain by loading them with the BYPASS instruction. Please see “BYPASS Data Register” on page 53 for more information.

5.4.2 Data Registers

The JTAG module contains six Data Registers. These include: IDCODE, BYPASS, Boundary Scan, APACC, DPACC, and ABORT serial Data Register chains. Each of these Data Registers is discussed in the following sections.

5.4.2.1 IDCODE Data Register

The format for the 32-bit IDCODE Data Register defined by the *IEEE Standard 1149.1* is shown in Figure 5-3 on page 53. The standard requires that every JTAG-compliant device implement either the IDCODE instruction or the BYPASS instruction as the default instruction. The LSB of the IDCODE Data Register is defined to be a 1 to distinguish it from the BYPASS instruction, which has an LSB of 0. This allows auto configuration test tools to determine which instruction is the default instruction.

The major uses of the JTAG port are for manufacturer testing of component assembly, and program development and debug. To facilitate the use of auto-configuration debug tools, the IDCODE instruction outputs a value of 0x3BA00477. This value indicates an ARM Cortex-M3, Version 1 processor. This allows the debuggers to automatically configure themselves to work correctly with the Cortex-M3 during debug.

Figure 5-3. IDCODE Register Format

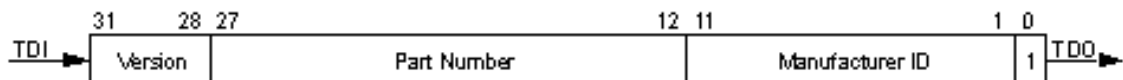

5.4.2.2 BYPASS Data Register

The format for the 1-bit BYPASS Data Register defined by the *IEEE Standard 1149.1* is shown in Figure 5-4 on page 54. The standard requires that every JTAG-compliant device implement either the BYPASS instruction or the IDCODE instruction as the default instruction. The LSB of the BYPASS Data Register is defined to be a 0 to distinguish it from the IDCODE instruction, which has an LSB of 1. This allows auto configuration test tools to determine which instruction is the default instruction.

Figure 5-4. BYPASS Register Format

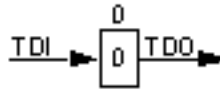

5.4.2.3 Boundary Scan Data Register

The format of the Boundary Scan Data Register is shown in Figure 5-5 on page 54. Each GPIO pin, in a counter-clockwise direction from the JTAG port pins, is included in the Boundary Scan Data Register. Each GPIO pin has three associated digital signals that are included in the chain. These signals are input, output, and output enable, and are arranged in that order as can be seen in the figure. In addition to the GPIO pins, the controller reset pin, \overline{RST} , is included in the chain. Because the reset pin is always an input, only the input signal is included in the Data Register chain.

When the Boundary Scan Data Register is accessed with the SAMPLE/PRELOAD instruction, the input, output, and output enable from each digital pad are sampled and then shifted out of the chain to be verified. The sampling of these values occurs on the rising edge of TCK in the Capture DR state of the TAP controller. While the sampled data is being shifted out of the Boundary Scan chain in the Shift DR state of the TAP controller, new data can be preloaded into the chain for use with the EXTEST and INTEST instructions. These instructions either force data out of the controller, with the EXTEST instruction, or into the controller, with the INTEST instruction.

Figure 5-5. Boundary Scan Register Format

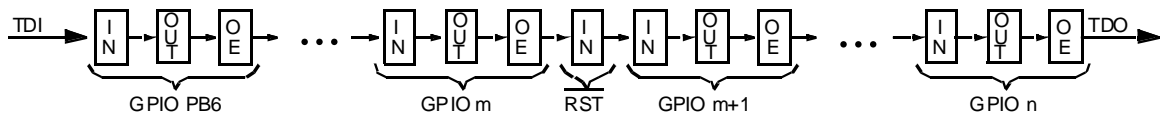

For detailed information on the order of the input, output, and output enable bits for each of the GPIO ports, please refer to the Stellaris® Family Boundary Scan Description Language (BSDL) files, downloadable from www.luminarymicro.com.

5.4.2.4 APACC Data Register

The format for the 35-bit APACC Data Register defined by ARM is described in the *ARM® Cortex™-M3 Technical Reference Manual*.

5.4.2.5 DPACC Data Register

The format for the 35-bit DPACC Data Register defined by ARM is described in the *ARM® Cortex™-M3 Technical Reference Manual*.

5.4.2.6 ABORT Data Register

The format for the 35-bit ABORT Data Register defined by ARM is described in the *ARM® Cortex™-M3 Technical Reference Manual*.

6 System Control

System control determines the overall operation of the device. It provides information about the device, controls the clocking to the core and individual peripherals, and handles reset detection and reporting.

6.1 Functional Description

The System Control module provides the following capabilities:

- Device identification, see “Device Identification” on page 55
- Local control, such as reset (see “Reset Control” on page 55), power (see “Power Control” on page 58) and clock control (see “Clock Control” on page 58)
- System control (Run, Sleep, and Deep-Sleep modes), see “System Control” on page 60

6.1.1 Device Identification

Seven read-only registers provide software with information on the microcontroller, such as version, part number, SRAM size, flash size, and other features. See the **DID0**, **DID1**, and **DC0-DC4** registers.

6.1.2 Reset Control

This section discusses aspects of hardware functions during reset as well as system software requirements following the reset sequence.

6.1.2.1 CMOD0 and CMOD1 Test-Mode Control Pins

Two pins, **CMOD0** and **CMOD1**, are defined for use by Luminary Micro for testing the devices during manufacture. They have no end-user function and should not be used. The **CMOD** pins should be connected to ground.

6.1.2.2 Reset Sources

The controller has five sources of reset:

1. External reset input pin ($\overline{\text{RST}}$) assertion, see “ $\overline{\text{RST}}$ Pin Assertion” on page 55.
2. Power-on reset (POR), see “Power-On Reset (POR)” on page 56.
3. Internal brown-out (BOR) detector, see “Brown-Out Reset (BOR)” on page 56.
4. Software-initiated reset (with the software reset registers), see “Software Reset” on page 57.
5. A watchdog timer reset condition violation, see “Watchdog Timer Reset” on page 57.

After a reset, the **Reset Cause (RESC)** register is set with the reset cause. The bits in this register are sticky and maintain their state across multiple reset sequences, except when an internal POR is the cause, and then all the other bits in the **RESC** register are cleared except for the POR indicator.

6.1.2.3 $\overline{\text{RST}}$ Pin Assertion

The external reset pin ($\overline{\text{RST}}$) resets the controller. This resets the core and all the peripherals except the JTAG TAP controller (see “JTAG Interface” on page 44). The external reset sequence is as follows:

1. The external reset pin ($\overline{\text{RST}}$) is asserted and then de-asserted.
2. The internal reset is released and the core loads from memory the initial stack pointer, the initial program counter, the first instruction designated by the program counter, and begins execution. A few clocks cycles from $\overline{\text{RST}}$ de-assertion to the start of the reset sequence is necessary for synchronization.

The external reset timing is shown in Figure 21-11 on page 508.

6.1.2.4 Power-On Reset (POR)

The Power-On Reset (POR) circuit monitors the power supply voltage (V_{DD}). The POR circuit generates a reset signal to the internal logic when the power supply ramp reaches a threshold value (V_{TH}). If the application only uses the POR circuit, the $\overline{\text{RST}}$ input needs to be connected to the power supply (V_{DD}) through a pull-up resistor (1K to 10K Ω).

The device must be operating within the specified operating parameters at the point when the on-chip power-on reset pulse is complete. The 3.3-V power supply to the device must reach 3.0 V within 10 msec of it crossing 2.0 V to guarantee proper operation. For applications that require the use of an external reset to hold the device in reset longer than the internal POR, the $\overline{\text{RST}}$ input may be used with the circuit as shown in Figure 6-1 on page 56.

Figure 6-1. External Circuitry to Extend Reset

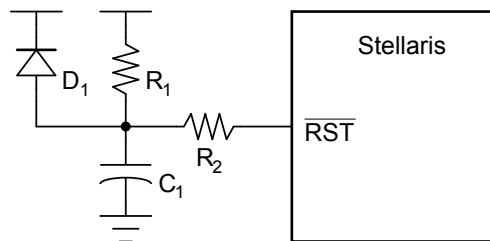

The R_1 and C_1 components define the power-on delay. The R_2 resistor mitigates any leakage from the $\overline{\text{RST}}$ input. The diode (D_1) discharges C_1 rapidly when the power supply is turned off.

The Power-On Reset sequence is as follows:

1. The controller waits for the later of external reset ($\overline{\text{RST}}$) or internal POR to go inactive.
2. The internal reset is released and the core loads from memory the initial stack pointer, the initial program counter, the first instruction designated by the program counter, and begins execution.

The internal POR is only active on the initial power-up of the controller. The Power-On Reset timing is shown in Figure 21-12 on page 508.

Note: The power-on reset also resets the JTAG controller. An external reset does not.

6.1.2.5 Brown-Out Reset (BOR)

A drop in the input voltage resulting in the assertion of the internal brown-out detector can be used to reset the controller. This is initially disabled and may be enabled by software.

The system provides a brown-out detection circuit that triggers if the power supply (V_{DD}) drops below a brown-out threshold voltage (V_{BTH}). If a brown-out condition is detected, the system may generate a controller interrupt or a system reset.

Brown-out resets are controlled with the **Power-On and Brown-Out Reset Control (PBORCTL)** register. The `BORIOR` bit in the **PBORCTL** register must be set for a brown-out condition to trigger a reset.

The brown-out reset is equivalent to an assertion of the external \overline{RST} input and the reset is held active until the proper V_{DD} level is restored. The **RESC** register can be examined in the reset interrupt handler to determine if a Brown-Out condition was the cause of the reset, thus allowing software to determine what actions are required to recover.

The internal Brown-Out Reset timing is shown in Figure 21-13 on page 508.

6.1.2.6 Software Reset

Software can reset a specific peripheral or generate a reset to the entire system .

Peripherals can be individually reset by software via three registers that control reset signals to each peripheral (see the **SRCRn** registers). If the bit position corresponding to a peripheral is set and subsequently cleared, the peripheral is reset. The encoding of the reset registers is consistent with the encoding of the clock gating control for peripherals and on-chip functions (see “System Control” on page 60). Note that all reset signals for all clocks of the specified unit are asserted as a result of a software-initiated reset.

The entire system can be reset by software by setting the `SYSRESETREQ` bit in the Cortex-M3 Application Interrupt and Reset Control register resets the entire system including the core. The software-initiated system reset sequence is as follows:

1. A software system reset is initiated by writing the `SYSRESETREQ` bit in the ARM Cortex-M3 Application Interrupt and Reset Control register.
2. An internal reset is asserted.
3. The internal reset is deasserted and the controller loads from memory the initial stack pointer, the initial program counter, and the first instruction designated by the program counter, and then begins execution.

The software-initiated system reset timing is shown in Figure 21-14 on page 509.

6.1.2.7 Watchdog Timer Reset

The watchdog timer module's function is to prevent system hangs. The watchdog timer can be configured to generate an interrupt to the controller on its first time-out, and to generate a reset signal on its second time-out.

After the first time-out event, the 32-bit counter is reloaded with the value of the **Watchdog Timer Load (WDTLOAD)** register, and the timer resumes counting down from that value. If the timer counts down to its zero state again before the first time-out interrupt is cleared, and the reset signal has been enabled, the watchdog timer asserts its reset signal to the system. The watchdog timer reset sequence is as follows:

1. The watchdog timer times out for the second time without being serviced.
2. An internal reset is asserted.
3. The internal reset is released and the controller loads from memory the initial stack pointer, the initial program counter, the first instruction designated by the program counter, and begins execution.

The watchdog reset timing is shown in Figure 21-15 on page 509.

6.1.3 Power Control

The Stellaris[®] microcontroller provides an integrated LDO regulator that may be used to provide power to the majority of the controller's internal logic. The LDO regulator provides software a mechanism to adjust the regulated value, in small increments (VSTEP), over the range of 2.25 V to 2.75 V (inclusive)—or $2.5\text{ V} \pm 10\%$. The adjustment is made by changing the value of the VADJ field in the **LDO Power Control (LDOPCTL)** register.

Note: The use of the LDO is optional. The internal logic may be supplied by the on-chip LDO or by an external regulator. If the LDO is used, the LDO output pin is connected to the VDD25 pins on the printed circuit board. The LDO requires decoupling capacitors on the printed circuit board. If an external regulator is used, it is strongly recommended that the external regulator supply the controller only and not be shared with other devices on the printed circuit board.

6.1.4 Clock Control

System control determines the control of clocks in this part.

6.1.4.1 Fundamental Clock Sources

There are four clock sources for use in the device:

- **Internal Oscillator (IOSC):** The internal oscillator is an on-chip clock source. It does not require the use of any external components. The frequency of the internal oscillator is $12\text{ MHz} \pm 30\%$. Applications that do not depend on accurate clock sources may use this clock source to reduce system cost. The internal oscillator is the clock source the device uses during and following POR. If the main oscillator is required, software must enable the main oscillator following reset and allow the main oscillator to stabilize before changing the clock reference.
- **Main Oscillator:** The main oscillator provides a frequency-accurate clock source by one of two means: an external single-ended clock source is connected to the OSC0 input pin, or an external crystal is connected across the OSC0 input and OSC1 output pins. The crystal value allowed depends on whether the main oscillator is used as the clock reference source to the PLL. If so, the crystal must be one of the supported frequencies between 3.579545 MHz through 8.192 MHz (inclusive). If the PLL is not being used, the crystal may be any one of the supported frequencies between 1 MHz and 8.192 MHz. The single-ended clock source range is from DC through the specified speed of the device. The supported crystals are listed in the XTAL bit in the **RCC** register (see page 71).
- **Internal 30-kHz Oscillator:** The internal 30-kHz oscillator is similar to the internal oscillator, except that it provides an operational frequency of $30\text{ kHz} \pm 30\%$. It is intended for use during Deep-Sleep power-saving modes. This power-savings mode benefits from reduced internal switching and also allows the main oscillator to be powered down.
- **External Real-Time Oscillator:** The external real-time oscillator provides a low-frequency, accurate clock reference. It is intended to provide the system with a real-time clock source. The real-time oscillator is part of the Hibernation Module (“Hibernation Module” on page 113) and may also provide an accurate source of Deep-Sleep or Hibernate mode power savings.

The internal system clock (sysclk), is derived from any of the four sources plus two others: the output of the internal PLL, and the internal oscillator divided by four ($3\text{ MHz} \pm 30\%$). The frequency of the PLL clock reference must be in the range of 3.579545 MHz to 8.192 MHz (inclusive).

The **Run-Mode Clock Configuration (RCC)** and **Run-Mode Clock Configuration 2 (RCC2)** registers provide control for the system clock. The **RCC2** register is provided to extend fields that offer additional encodings over the **RCC** register. When used, the **RCC2** register field values are used by the logic over the corresponding field in the **RCC** register. In particular, **RCC2** provides for a larger assortment of clock configuration options.

6.1.4.2 Crystal Configuration for the Main Oscillator (MOSC)

The main oscillator supports the use of a select number of crystals. If the main oscillator is used by the PLL as a reference clock, the supported range of crystals is 3.579545 to 8.192 MHz, otherwise, the range of supported crystals is 1 to 8.192 MHz.

The **XTAL** bit in the **RCC** register (see page 71) describes the available crystal choices and default programming values.

Software configures the **RCC** register **XTAL** field with the crystal number. If the PLL is used in the design, the **XTAL** field value is internally translated to the PLL settings.

6.1.4.3 PLL Frequency Configuration

The PLL is disabled by default during power-on reset and is enabled later by software if required. Software configures the PLL input reference clock source, specifies the output divisor to set the system clock frequency, and enables the PLL to drive the output.

If the main oscillator provides the clock reference to the PLL, the translation provided by hardware and used to program the PLL is available for software in the **XTAL to PLL Translation (PLLCFG)** register (see page 75). The internal translation provides a translation within $\pm 1\%$ of the targeted PLL VCO frequency.

The Crystal Value field (**XTAL**) on page 71 describes the available crystal choices and default programming of the **PLLCFG** register. The crystal number is written into the **XTAL** field of the **Run-Mode Clock Configuration (RCC)** register. Any time the **XTAL** field changes, the new settings are translated and the internal PLL settings are updated.

6.1.4.4 PLL Modes

The PLL has two modes of operation: Normal and Power-Down

- Normal: The PLL multiplies the input clock reference and drives the output.
- Power-Down: Most of the PLL internal circuitry is disabled and the PLL does not drive the output.

The modes are programmed using the **RCC/RCC2** register fields (see page 71 and page 76).

6.1.4.5 PLL Operation

If the PLL configuration is changed, the PLL output frequency is unstable until it reconverges (relocks) to the new setting. The time between the configuration change and relock is T_{READY} (see Table 21-6 on page 498). During this time, the PLL is not usable as a clock reference.

The PLL is changed by one of the following:

- Change to the **XTAL** value in the **RCC** register—writes of the same value do not cause a relock.
- Change in the PLL from Power-Down to Normal mode.

A counter is defined to measure the T_{READY} requirement. The counter is clocked by the main oscillator. The range of the main oscillator has been taken into account and the down counter is set

to 0x1200 (that is, ~600 μ s at an 8.192 MHz external oscillator clock). Hardware is provided to keep the PLL from being used as a system clock until the T_{READY} condition is met after one of the two changes above. It is the user's responsibility to have a stable clock source (like the main oscillator) before the **RCC/RCC2** register is switched to use the PLL.

6.1.5 System Control

For power-savings purposes, the **RCGCn**, **SCGCn**, and **DCGCn** registers control the clock gating logic for each peripheral or block in the system while the controller is in Run, Sleep, and Deep-Sleep mode, respectively.

In Run mode, the processor executes code. In Sleep mode, the clock frequency of the active peripherals is unchanged, but the processor is not clocked and therefore no longer executes code. In Deep-Sleep mode, the clock frequency of the active peripherals may change (depending on the Run mode clock configuration) in addition to the processor clock being stopped. An interrupt returns the device to Run mode from one of the sleep modes; the sleep modes are entered on request from the code. Each mode is described in more detail below.

There are four levels of operation for the device defined as:

- **Run Mode.** Run mode provides normal operation of the processor and all of the peripherals that are currently enabled by the **RCGCn** registers. The system clock can be any of the available clock sources including the PLL.
- **Sleep Mode.** Sleep mode is entered by the Cortex-M3 core executing a **WFI** (Wait for Interrupt) instruction. Any properly configured interrupt event in the system will bring the processor back into Run mode. See the system control NVIC section of the *ARM® Cortex™-M3 Technical Reference Manual* for more details.

In Sleep mode, the Cortex-M3 processor core and the memory subsystem are not clocked. Peripherals are clocked that are enabled in the **SCGCn** register when auto-clock gating is enabled (see the **RCC** register) or the **RCGCn** register when the auto-clock gating is disabled. The system clock has the same source and frequency as that during Run mode.

- **Deep-Sleep Mode.** Deep-Sleep mode is entered by first writing the Deep Sleep Enable bit in the ARM Cortex-M3 NVIC system control register and then executing a **WFI** instruction. Any properly configured interrupt event in the system will bring the processor back into Run mode. See the system control NVIC section of the *ARM® Cortex™-M3 Technical Reference Manual* for more details.

The Cortex-M3 processor core and the memory subsystem are not clocked. Peripherals are clocked that are enabled in the **DCGCn** register when auto-clock gating is enabled (see the **RCC** register) or the **RCGCn** register when auto-clock gating is disabled. The system clock source is the main oscillator by default or the internal oscillator specified in the **DSLPCCLKCFG** register if one is enabled. When the **DSLPCCLKCFG** register is used, the internal oscillator is powered up, if necessary, and the main oscillator is powered down. If the PLL is running at the time of the **WFI** instruction, hardware will power the PLL down and override the **SYSDIV** field of the active **RCC/RCC2** register to be /16 or /64, respectively. When the Deep-Sleep exit event occurs, hardware brings the system clock back to the source and frequency it had at the onset of Deep-Sleep mode before enabling the clocks that had been stopped during the Deep-Sleep duration.

- **Hibernate Mode.** In this mode, the power supplies are turned off to the main part of the device and only the Hibernation module's circuitry is active. An external wake event or RTC event is required to bring the device back to Run mode. The Cortex-M3 processor and peripherals outside

of the Hibernation module see a normal "power on" sequence and the processor starts running code. It can determine that it has been restarted from Hibernate mode by inspecting the Hibernation module registers.

6.2 Initialization and Configuration

The PLL is configured using direct register writes to the **RCC/RCC2** register. If the **RCC2** register is being used, the **USERCC2** bit must be set and the appropriate **RCC2** bit/field is used. The steps required to successfully change the PLL-based system clock are:

1. Bypass the PLL and system clock divider by setting the **BYPASS** bit and clearing the **USESYS** bit in the **RCC** register. This configures the system to run off a "raw" clock source (using the main oscillator or internal oscillator) and allows for the new PLL configuration to be validated before switching the system clock to the PLL.
2. Select the crystal value (**XTAL**) and oscillator source (**OSCSRC**), and clear the **PWRDN** bit in **RCC/RCC2**. Setting the **XTAL** field automatically pulls valid PLL configuration data for the appropriate crystal, and clearing the **PWRDN** bit powers and enables the PLL and its output.
3. Select the desired system divider (**SYSDIV**) in **RCC/RCC2** and set the **USESYS** bit in **RCC**. The **SYSDIV** field determines the system frequency for the microcontroller.
4. Wait for the PLL to lock by polling the **PLLLRIS** bit in the **Raw Interrupt Status (RIS)** register.
5. Enable use of the PLL by clearing the **BYPASS** bit in **RCC/RCC2**.

6.3 Register Map

Table 6-1 on page 61 lists the System Control registers, grouped by function. The offset listed is a hexadecimal increment to the register's address, relative to the System Control base address of 0x400F.E000.

Note: Spaces in the System Control register space that are not used are reserved for future or internal use by Luminary Micro, Inc. Software should not modify any reserved memory address.

Table 6-1. System Control Register Map

Offset	Name	Type	Reset	Description	See page
0x000	DID0	RO	-	Device Identification 0	63
0x004	DID1	RO	-	Device Identification 1	79
0x008	DC0	RO	0x00FF.007F	Device Capabilities 0	81
0x010	DC1	RO	0x0011.32DF	Device Capabilities 1	82
0x014	DC2	RO	0x000F.1017	Device Capabilities 2	84
0x018	DC3	RO	0x3F3F.8003	Device Capabilities 3	86
0x01C	DC4	RO	0x5000.007F	Device Capabilities 4	88
0x030	PBORCTL	R/W	0x0000.7FFD	Brown-Out Reset Control	65
0x034	LDOPCTL	R/W	0x0000.0000	LDO Power Control	66

Offset	Name	Type	Reset	Description	See page
0x040	SRCR0	R/W	0x00000000	Software Reset Control 0	108
0x044	SRCR1	R/W	0x00000000	Software Reset Control 1	109
0x048	SRCR2	R/W	0x00000000	Software Reset Control 2	111
0x050	RIS	RO	0x0000.0000	Raw Interrupt Status	67
0x054	IMC	R/W	0x0000.0000	Interrupt Mask Control	68
0x058	MISC	R/W1C	0x0000.0000	Masked Interrupt Status and Clear	69
0x05C	RESC	R/W	-	Reset Cause	70
0x060	RCC	R/W	0x07AE.3AD1	Run-Mode Clock Configuration	71
0x064	PLLCFG	RO	-	XTAL to PLL Translation	75
0x070	RCC2	R/W	0x0780.2800	Run-Mode Clock Configuration 2	76
0x100	RCGC0	R/W	0x00000040	Run Mode Clock Gating Control Register 0	90
0x104	RCGC1	R/W	0x00000000	Run Mode Clock Gating Control Register 1	96
0x108	RCGC2	R/W	0x00000000	Run Mode Clock Gating Control Register 2	102
0x110	SCGC0	R/W	0x00000040	Sleep Mode Clock Gating Control Register 0	92
0x114	SCGC1	R/W	0x00000000	Sleep Mode Clock Gating Control Register 1	98
0x118	SCGC2	R/W	0x00000000	Sleep Mode Clock Gating Control Register 2	104
0x120	DCGC0	R/W	0x00000040	Deep Sleep Mode Clock Gating Control Register 0	94
0x124	DCGC1	R/W	0x00000000	Deep Sleep Mode Clock Gating Control Register 1	100
0x128	DCGC2	R/W	0x00000000	Deep Sleep Mode Clock Gating Control Register 2	106
0x144	DSLPCCLKCFG	R/W	0x0780.0000	Deep Sleep Clock Configuration	78

6.4 Register Descriptions

All addresses given are relative to the System Control base address of 0x400F.E000.

Register 1: Device Identification 0 (DID0), offset 0x000

This register identifies the version of the device.

Device Identification 0 (DID0)

Base 0x400F.E000

Offset 0x000

Type RO, reset -

	31	30	29	28	27	26	25	24	23	22	21	20	19	18	17	16
	reserved	VER			reserved				CLASS							
Type	RO	RO	RO	RO	RO	RO	RO	RO	RO	RO	RO	RO	RO	RO	RO	RO
Reset	0	0	0	1	0	0	0	0	0	0	0	0	0	0	0	1
	15	14	13	12	11	10	9	8	7	6	5	4	3	2	1	0
	MAJOR								MINOR							
Type	RO	RO	RO	RO	RO	RO	RO	RO	RO	RO	RO	RO	RO	RO	RO	RO
Reset	-	-	-	-	-	-	-	-	-	-	-	-	-	-	-	-

Bit/Field	Name	Type	Reset	Description						
31	reserved	RO	0	Software should not rely on the value of a reserved bit. To provide compatibility with future products, the value of a reserved bit should be preserved across a read-modify-write operation.						
30:28	VER	RO	0x1	<p>DID0 Version</p> <p>This field defines the DID0 register format version. The version number is numeric. The value of the <code>VER</code> field is encoded as follows:</p> <table border="1"> <thead> <tr> <th>Value</th> <th>Description</th> </tr> </thead> <tbody> <tr> <td>0x1</td> <td>First revision of the DID0 register format, for Stellaris® Fury-class devices .</td> </tr> </tbody> </table>	Value	Description	0x1	First revision of the DID0 register format, for Stellaris® Fury-class devices .		
Value	Description									
0x1	First revision of the DID0 register format, for Stellaris® Fury-class devices .									
27:24	reserved	RO	0x0	Software should not rely on the value of a reserved bit. To provide compatibility with future products, the value of a reserved bit should be preserved across a read-modify-write operation.						
23:16	CLASS	RO	0x1	<p>Device Class</p> <p>The <code>CLASS</code> field value identifies the internal design from which all mask sets are generated for all devices in a particular product line. The <code>CLASS</code> field value is changed for new product lines, for changes in fab process (for example, a remap or shrink), or any case where the <code>MAJOR</code> or <code>MINOR</code> fields require differentiation from prior devices. The value of the <code>CLASS</code> field is encoded as follows (all other encodings are reserved):</p> <table border="1"> <thead> <tr> <th>Value</th> <th>Description</th> </tr> </thead> <tbody> <tr> <td>0x0</td> <td>Stellaris® Sandstorm-class devices.</td> </tr> <tr> <td>0x1</td> <td>Stellaris® Fury-class devices.</td> </tr> </tbody> </table>	Value	Description	0x0	Stellaris® Sandstorm-class devices.	0x1	Stellaris® Fury-class devices.
Value	Description									
0x0	Stellaris® Sandstorm-class devices.									
0x1	Stellaris® Fury-class devices.									

Bit/Field	Name	Type	Reset	Description								
15:8	MAJOR	RO	-	<p>Major Revision</p> <p>This field specifies the major revision number of the device. The major revision reflects changes to base layers of the design. The major revision number is indicated in the part number as a letter (A for first revision, B for second, and so on). This field is encoded as follows:</p> <table><thead><tr><th>Value</th><th>Description</th></tr></thead><tbody><tr><td>0x0</td><td>Revision A (initial device)</td></tr><tr><td>0x1</td><td>Revision B (first base layer revision)</td></tr><tr><td>0x2</td><td>Revision C (second base layer revision)</td></tr></tbody></table> <p>and so on.</p>	Value	Description	0x0	Revision A (initial device)	0x1	Revision B (first base layer revision)	0x2	Revision C (second base layer revision)
Value	Description											
0x0	Revision A (initial device)											
0x1	Revision B (first base layer revision)											
0x2	Revision C (second base layer revision)											
7:0	MINOR	RO	-	<p>Minor Revision</p> <p>This field specifies the minor revision number of the device. The minor revision reflects changes to the metal layers of the design. The <code>MINOR</code> field value is reset when the <code>MAJOR</code> field is changed. This field is numeric and is encoded as follows:</p> <table><thead><tr><th>Value</th><th>Description</th></tr></thead><tbody><tr><td>0x0</td><td>Initial device, or a major revision update.</td></tr><tr><td>0x1</td><td>First metal layer change.</td></tr><tr><td>0x2</td><td>Second metal layer change.</td></tr></tbody></table> <p>and so on.</p>	Value	Description	0x0	Initial device, or a major revision update.	0x1	First metal layer change.	0x2	Second metal layer change.
Value	Description											
0x0	Initial device, or a major revision update.											
0x1	First metal layer change.											
0x2	Second metal layer change.											

Register 2: Brown-Out Reset Control (PBORCTL), offset 0x030

This register is responsible for controlling reset conditions after initial power-on reset.

Brown-Out Reset Control (PBORCTL)

Base 0x400F.E000

Offset 0x030

Type R/W, reset 0x0000.7FFD

	31	30	29	28	27	26	25	24	23	22	21	20	19	18	17	16	
	reserved																
Type	RO	RO	RO	RO	RO	RO	RO	RO	RO	RO	RO	RO	RO	RO	RO	RO	
Reset	0	0	0	0	0	0	0	0	0	0	0	0	0	0	0	0	
	15	14	13	12	11	10	9	8	7	6	5	4	3	2	1	0	
	reserved															BORIOR	reserved
Type	RO	RO	RO	RO	RO	RO	RO	RO	RO	RO	RO	RO	RO	RO	RO	R/W	RO
Reset	0	0	0	0	0	0	0	0	0	0	0	0	0	0	0	0	0

Bit/Field	Name	Type	Reset	Description
31:2	reserved	RO	0x0	Software should not rely on the value of a reserved bit. To provide compatibility with future products, the value of a reserved bit should be preserved across a read-modify-write operation.
1	BORIOR	R/W	0	BOR Interrupt or Reset This bit controls how a BOR event is signaled to the controller. If set, a reset is signaled. Otherwise, an interrupt is signaled.
0	reserved	RO	0	Software should not rely on the value of a reserved bit. To provide compatibility with future products, the value of a reserved bit should be preserved across a read-modify-write operation.

Register 3: LDO Power Control (LDOPCTL), offset 0x034

The V_{ADJ} field in this register adjusts the on-chip output voltage (V_{OUT}).

LDO Power Control (LDOPCTL)

Base 0x400F.E000
 Offset 0x034
 Type R/W, reset 0x0000.0000

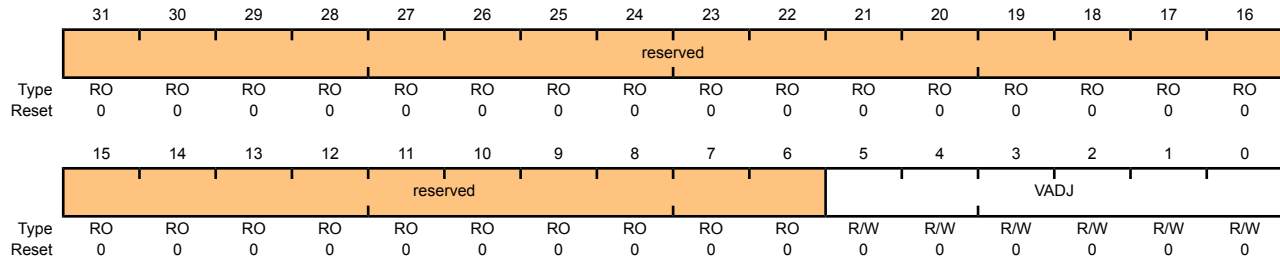

Bit/Field	Name	Type	Reset	Description
31:6	reserved	RO	0	Software should not rely on the value of a reserved bit. To provide compatibility with future products, the value of a reserved bit should be preserved across a read-modify-write operation.

5:0	VADJ	R/W	0x0	LDO Output Voltage
				This field sets the on-chip output voltage. The programming values for the V_{ADJ} field are provided below.

Value	V_{OUT} (V)
0x00	2.50
0x01	2.45
0x02	2.40
0x03	2.35
0x04	2.30
0x05	2.25
0x06-0x3F	Reserved
0x1B	2.75
0x1C	2.70
0x1D	2.65
0x1E	2.60
0x1F	2.55

Register 4: Raw Interrupt Status (RIS), offset 0x050

Central location for system control raw interrupts. These are set and cleared by hardware.

Raw Interrupt Status (RIS)

Base 0x400F.E000

Offset 0x050

Type RO, reset 0x0000.0000

	31	30	29	28	27	26	25	24	23	22	21	20	19	18	17	16	
	reserved																
Type	RO	RO	RO	RO	RO	RO	RO	RO	RO	RO	RO	RO	RO	RO	RO	RO	
Reset	0	0	0	0	0	0	0	0	0	0	0	0	0	0	0	0	
	15	14	13	12	11	10	9	8	7	6	5	4	3	2	1	0	
	reserved										PLLLRIS	reserved				BORRIS	reserved
Type	RO	RO	RO	RO	RO	RO	RO	RO	RO	RO	RO	RO	RO	RO	RO	RO	
Reset	0	0	0	0	0	0	0	0	0	0	0	0	0	0	0	0	

Bit/Field	Name	Type	Reset	Description
31:7	reserved	RO	0	Software should not rely on the value of a reserved bit. To provide compatibility with future products, the value of a reserved bit should be preserved across a read-modify-write operation.
6	PLLLRIS	RO	0	PLL Lock Raw Interrupt Status This bit is set when the PLL T _{READY} Timer asserts.
5:2	reserved	RO	0	Software should not rely on the value of a reserved bit. To provide compatibility with future products, the value of a reserved bit should be preserved across a read-modify-write operation.
1	BORRIS	RO	0	Brown-Out Reset Raw Interrupt Status This bit is the raw interrupt status for any brown-out conditions. If set, a brown-out condition is currently active. This is an unregistered signal from the brown-out detection circuit. An interrupt is reported if the BORIM bit in the IMC register is set and the BORIOR bit in the PBORCTL register is cleared.
0	reserved	RO	0	Software should not rely on the value of a reserved bit. To provide compatibility with future products, the value of a reserved bit should be preserved across a read-modify-write operation.

Register 5: Interrupt Mask Control (IMC), offset 0x054

Central location for system control interrupt masks.

Interrupt Mask Control (IMC)

Base 0x400F.E000
 Offset 0x054
 Type R/W, reset 0x0000.0000

	31	30	29	28	27	26	25	24	23	22	21	20	19	18	17	16
	reserved															
Type	RO	RO	RO	RO	RO	RO	RO	RO	RO	RO	RO	RO	RO	RO	RO	RO
Reset	0	0	0	0	0	0	0	0	0	0	0	0	0	0	0	0
	15	14	13	12	11	10	9	8	7	6	5	4	3	2	1	0
	reserved										PLLIM	reserved			BORIM	reserved
Type	RO	RO	RO	RO	RO	RO	RO	RO	RO	RO	R/W	RO	RO	RO	RO	RO
Reset	0	0	0	0	0	0	0	0	0	0	0	0	0	0	0	0

Bit/Field	Name	Type	Reset	Description
31:7	reserved	RO	0	Software should not rely on the value of a reserved bit. To provide compatibility with future products, the value of a reserved bit should be preserved across a read-modify-write operation.
6	PLLIM	R/W	0	PLL Lock Interrupt Mask This bit specifies whether a current limit detection is promoted to a controller interrupt. If set, an interrupt is generated if <code>PLLRRIS</code> in RIS is set; otherwise, an interrupt is not generated.
5:2	reserved	RO	0	Software should not rely on the value of a reserved bit. To provide compatibility with future products, the value of a reserved bit should be preserved across a read-modify-write operation.
1	BORIM	R/W	0	Brown-Out Reset Interrupt Mask This bit specifies whether a brown-out condition is promoted to a controller interrupt. If set, an interrupt is generated if <code>BORRIS</code> is set; otherwise, an interrupt is not generated.
0	reserved	RO	0	Software should not rely on the value of a reserved bit. To provide compatibility with future products, the value of a reserved bit should be preserved across a read-modify-write operation.

Register 6: Masked Interrupt Status and Clear (MISC), offset 0x058

Central location for system control result of RIS AND IMC to generate an interrupt to the controller. All of the bits are R/W1C and this action also clears the corresponding raw interrupt bit in the **RIS** register (see page 67).

Masked Interrupt Status and Clear (MISC)

Base 0x400F.E000

Offset 0x058

Type R/W1C, reset 0x0000.0000

	31	30	29	28	27	26	25	24	23	22	21	20	19	18	17	16	
	reserved																
Type	RO	RO	RO	RO	RO	RO	RO	RO	RO	RO	RO	RO	RO	RO	RO	RO	
Reset	0	0	0	0	0	0	0	0	0	0	0	0	0	0	0	0	
	15	14	13	12	11	10	9	8	7	6	5	4	3	2	1	0	
	reserved										PLLLMIS	reserved				BORMIS	reserved
Type	RO	RO	RO	RO	RO	RO	RO	RO	RO	R/W1C	RO	RO	RO	RO	R/W1C	RO	
Reset	0	0	0	0	0	0	0	0	0	0	0	0	0	0	0	0	

Bit/Field	Name	Type	Reset	Description
31:7	reserved	RO	0	Software should not rely on the value of a reserved bit. To provide compatibility with future products, the value of a reserved bit should be preserved across a read-modify-write operation.
6	PLLLMIS	R/W1C	0	PLL Lock Masked Interrupt Status This bit is set when the PLL T _{READY} timer asserts. The interrupt is cleared by writing a 1 to this bit.
5:2	reserved	RO	0	Software should not rely on the value of a reserved bit. To provide compatibility with future products, the value of a reserved bit should be preserved across a read-modify-write operation.
1	BORMIS	R/W1C	0	BOR Masked Interrupt Status The BORMIS is simply the BORRIS ANDed with the mask value, BORIM.
0	reserved	RO	0	Software should not rely on the value of a reserved bit. To provide compatibility with future products, the value of a reserved bit should be preserved across a read-modify-write operation.

Register 7: Reset Cause (RESC), offset 0x05C

This register is set with the reset cause after reset. The bits in this register are sticky and maintain their state across multiple reset sequences, except when an external reset is the cause, and then all the other bits in the **RESC** register are cleared.

Reset Cause (RESC)

Base 0x400F.E000

Offset 0x05C

Type R/W, reset -

	31	30	29	28	27	26	25	24	23	22	21	20	19	18	17	16	
	reserved																
Type	RO	RO	RO	RO	RO	RO	RO	RO	RO	RO	RO	RO	RO	RO	RO	RO	
Reset	0	0	0	0	0	0	0	0	0	0	0	0	0	0	0	0	
	15	14	13	12	11	10	9	8	7	6	5	4	3	2	1	0	
	reserved											LDO	SW	WDT	BOR	POR	EXT
Type	RO	RO	RO	RO	RO	RO	RO	RO	RO	RO	R/W	R/W	R/W	R/W	R/W	R/W	
Reset	0	0	0	0	0	0	0	0	0	0	-	-	-	-	-	-	

Bit/Field	Name	Type	Reset	Description
31:6	reserved	RO	0	Software should not rely on the value of a reserved bit. To provide compatibility with future products, the value of a reserved bit should be preserved across a read-modify-write operation.
5	LDO	R/W	-	LDO Reset When set, indicates the LDO circuit has lost regulation and has generated a reset event.
4	SW	R/W	-	Software Reset When set, indicates a software reset is the cause of the reset event.
3	WDT	R/W	-	Watchdog Timer Reset When set, indicates a watchdog reset is the cause of the reset event.
2	BOR	R/W	-	Brown-Out Reset When set, indicates a brown-out reset is the cause of the reset event.
1	POR	R/W	-	Power-On Reset When set, indicates a power-on reset is the cause of the reset event.
0	EXT	R/W	-	External Reset When set, indicates an external reset (\overline{RST} assertion) is the cause of the reset event.

Register 8: Run-Mode Clock Configuration (RCC), offset 0x060

This register is defined to provide source control and frequency speed.

Run-Mode Clock Configuration (RCC)

Base 0x400F.E000

Offset 0x060

Type R/W, reset 0x07AE.3AD1

	31	30	29	28	27	26	25	24	23	22	21	20	19	18	17	16
	reserved				ACG	SYSDIV				USESYSDIV	reserved	USEPWMDIV	PWMDIV			reserved
Type	RO	RO	RO	RO	R/W	R/W	R/W	R/W	R/W	R/W	RO	R/W	R/W	R/W	R/W	RO
Reset	0	0	0	0	0	1	1	1	1	0	0	0	1	1	1	0
	15	14	13	12	11	10	9	8	7	6	5	4	3	2	1	0
	reserved		PWRDN	reserved	BYPASS	reserved	XTAL				OSCSRC		reserved		IOSCDIS	MOSCDIS
Type	RO	RO	R/W	RO	R/W	RO	R/W	R/W	R/W	R/W	R/W	R/W	RO	RO	R/W	R/W
Reset	0	0	1	1	1	0	1	0	1	1	0	1	0	0	0	1

Bit/Field	Name	Type	Reset	Description
31:28	reserved	RO	0x0	Software should not rely on the value of a reserved bit. To provide compatibility with future products, the value of a reserved bit should be preserved across a read-modify-write operation.
27	ACG	R/W	0	Auto Clock Gating

This bit specifies whether the system uses the **Sleep-Mode Clock Gating Control (SCGCn)** registers and **Deep-Sleep-Mode Clock Gating Control (DCGCn)** registers if the controller enters a Sleep or Deep-Sleep mode (respectively). If set, the **SCGCn** or **DCGCn** registers are used to control the clocks distributed to the peripherals when the controller is in a sleep mode. Otherwise, the **Run-Mode Clock Gating Control (RCGCn)** registers are used when the controller enters a sleep mode.

The **RCGCn** registers are always used to control the clocks in Run mode.

This allows peripherals to consume less power when the controller is in a sleep mode and the peripheral is unused.

Bit/Field	Name	Type	Reset	Description																																																			
26:23	SYSDIV	R/W	0xF	<p>System Clock Divisor</p> <p>Specifies which divisor is used to generate the system clock from the PLL output.</p> <p>The PLL VCO frequency is 400 MHz.</p> <table border="1"> <thead> <tr> <th>Value</th> <th>Divisor (BYPASS=1)</th> <th>Frequency (BYPASS=0)</th> </tr> </thead> <tbody> <tr><td>0x0</td><td>reserved</td><td>reserved</td></tr> <tr><td>0x1</td><td>/2</td><td>reserved</td></tr> <tr><td>0x2</td><td>/3</td><td>reserved</td></tr> <tr><td>0x3</td><td>/4</td><td>50 MHz</td></tr> <tr><td>0x4</td><td>/5</td><td>40 MHz</td></tr> <tr><td>0x5</td><td>/6</td><td>33.33 MHz</td></tr> <tr><td>0x6</td><td>/7</td><td>28.57 MHz</td></tr> <tr><td>0x7</td><td>/8</td><td>25 MHz</td></tr> <tr><td>0x8</td><td>/9</td><td>22.22 MHz</td></tr> <tr><td>0x9</td><td>/10</td><td>20 MHz</td></tr> <tr><td>0xA</td><td>/11</td><td>18.18 MHz</td></tr> <tr><td>0xB</td><td>/12</td><td>16.67 MHz</td></tr> <tr><td>0xC</td><td>/13</td><td>15.38 MHz</td></tr> <tr><td>0xD</td><td>/14</td><td>14.29 MHz</td></tr> <tr><td>0xE</td><td>/15</td><td>13.33 MHz</td></tr> <tr><td>0xF</td><td>/16</td><td>12.5 MHz (default)</td></tr> </tbody> </table> <p>When reading the Run-Mode Clock Configuration (RCC) register (see page 71), the SYSDIV value is MINSYSDIV if a lower divider was requested and the PLL is being used. This lower value is allowed to divide a non-PLL source.</p>	Value	Divisor (BYPASS=1)	Frequency (BYPASS=0)	0x0	reserved	reserved	0x1	/2	reserved	0x2	/3	reserved	0x3	/4	50 MHz	0x4	/5	40 MHz	0x5	/6	33.33 MHz	0x6	/7	28.57 MHz	0x7	/8	25 MHz	0x8	/9	22.22 MHz	0x9	/10	20 MHz	0xA	/11	18.18 MHz	0xB	/12	16.67 MHz	0xC	/13	15.38 MHz	0xD	/14	14.29 MHz	0xE	/15	13.33 MHz	0xF	/16	12.5 MHz (default)
Value	Divisor (BYPASS=1)	Frequency (BYPASS=0)																																																					
0x0	reserved	reserved																																																					
0x1	/2	reserved																																																					
0x2	/3	reserved																																																					
0x3	/4	50 MHz																																																					
0x4	/5	40 MHz																																																					
0x5	/6	33.33 MHz																																																					
0x6	/7	28.57 MHz																																																					
0x7	/8	25 MHz																																																					
0x8	/9	22.22 MHz																																																					
0x9	/10	20 MHz																																																					
0xA	/11	18.18 MHz																																																					
0xB	/12	16.67 MHz																																																					
0xC	/13	15.38 MHz																																																					
0xD	/14	14.29 MHz																																																					
0xE	/15	13.33 MHz																																																					
0xF	/16	12.5 MHz (default)																																																					
22	USESYSYSDIV	R/W	0	<p>Enable System Clock Divider</p> <p>Use the system clock divider as the source for the system clock. The system clock divider is forced to be used when the PLL is selected as the source.</p>																																																			
21	reserved	RO	0	<p>Software should not rely on the value of a reserved bit. To provide compatibility with future products, the value of a reserved bit should be preserved across a read-modify-write operation.</p>																																																			
20	USEPWMDIV	R/W	0	<p>Enable PWM Clock Divisor</p> <p>Use the PWM clock divider as the source for the PWM clock.</p>																																																			

Bit/Field	Name	Type	Reset	Description
19:17	PWMDIV	R/W	0x7	<p>PWM Unit Clock Divisor</p> <p>This field specifies the binary divisor used to predivide the system clock down for use as the timing reference for the PWM module. This clock is only power 2 divide and rising edge is synchronous without phase shift from the system clock.</p> <p>Value Divisor</p> <p>0x0 /2</p> <p>0x1 /4</p> <p>0x2 /8</p> <p>0x3 /16</p> <p>0x4 /32</p> <p>0x5 /64</p> <p>0x6 /64</p> <p>0x7 /64 (default)</p>
16:14	reserved	RO	0	Software should not rely on the value of a reserved bit. To provide compatibility with future products, the value of a reserved bit should be preserved across a read-modify-write operation.
13	PWRDN	R/W	1	<p>PLL Power Down</p> <p>This bit connects to the PLL PWRDN input. The reset value of 1 powers down the PLL.</p>
12	reserved	RO	1	Software should not rely on the value of a reserved bit. To provide compatibility with future products, the value of a reserved bit should be preserved across a read-modify-write operation.
11	BYPASS	R/W	1	<p>PLL Bypass</p> <p>Chooses whether the system clock is derived from the PLL output or the OSC source. If set, the clock that drives the system is the OSC source. Otherwise, the clock that drives the system is the PLL output clock divided by the system divider.</p> <p>Note: The ADC must be clocked from the PLL or directly from a 14-MHz to 18-MHz clock source to operate properly. While the ADC works in a 14-18 MHz range, to maintain a 1 M sample/second rate, the ADC must be provided a 16-MHz clock source.</p>
10	reserved	RO	0	Software should not rely on the value of a reserved bit. To provide compatibility with future products, the value of a reserved bit should be preserved across a read-modify-write operation.

Bit/Field	Name	Type	Reset	Description																																																			
9:6	XTAL	R/W	0xB	<p>Crystal Value</p> <p>This field specifies the crystal value attached to the main oscillator. The encoding for this field is provided below.</p> <table border="1"> <thead> <tr> <th>Value</th> <th>Crystal Frequency (MHz) Not Using the PLL</th> <th>Crystal Frequency (MHz) Using the PLL</th> </tr> </thead> <tbody> <tr><td>0x0</td><td>1.000</td><td>reserved</td></tr> <tr><td>0x1</td><td>1.8432</td><td>reserved</td></tr> <tr><td>0x2</td><td>2.000</td><td>reserved</td></tr> <tr><td>0x3</td><td>2.4576</td><td>reserved</td></tr> <tr><td>0x4</td><td></td><td>3.579545 MHz</td></tr> <tr><td>0x5</td><td></td><td>3.6864 MHz</td></tr> <tr><td>0x6</td><td></td><td>4 MHz</td></tr> <tr><td>0x7</td><td></td><td>4.096 MHz</td></tr> <tr><td>0x8</td><td></td><td>4.9152 MHz</td></tr> <tr><td>0x9</td><td></td><td>5 MHz</td></tr> <tr><td>0xA</td><td></td><td>5.12 MHz</td></tr> <tr><td>0xB</td><td></td><td>6 MHz (reset value)</td></tr> <tr><td>0xC</td><td></td><td>6.144 MHz</td></tr> <tr><td>0xD</td><td></td><td>7.3728 MHz</td></tr> <tr><td>0xE</td><td></td><td>8 MHz</td></tr> <tr><td>0xF</td><td></td><td>8.192 MHz</td></tr> </tbody> </table>	Value	Crystal Frequency (MHz) Not Using the PLL	Crystal Frequency (MHz) Using the PLL	0x0	1.000	reserved	0x1	1.8432	reserved	0x2	2.000	reserved	0x3	2.4576	reserved	0x4		3.579545 MHz	0x5		3.6864 MHz	0x6		4 MHz	0x7		4.096 MHz	0x8		4.9152 MHz	0x9		5 MHz	0xA		5.12 MHz	0xB		6 MHz (reset value)	0xC		6.144 MHz	0xD		7.3728 MHz	0xE		8 MHz	0xF		8.192 MHz
Value	Crystal Frequency (MHz) Not Using the PLL	Crystal Frequency (MHz) Using the PLL																																																					
0x0	1.000	reserved																																																					
0x1	1.8432	reserved																																																					
0x2	2.000	reserved																																																					
0x3	2.4576	reserved																																																					
0x4		3.579545 MHz																																																					
0x5		3.6864 MHz																																																					
0x6		4 MHz																																																					
0x7		4.096 MHz																																																					
0x8		4.9152 MHz																																																					
0x9		5 MHz																																																					
0xA		5.12 MHz																																																					
0xB		6 MHz (reset value)																																																					
0xC		6.144 MHz																																																					
0xD		7.3728 MHz																																																					
0xE		8 MHz																																																					
0xF		8.192 MHz																																																					
5:4	OSCSRC	R/W	0x1	<p>Oscillator Source</p> <p>Picks among the four input sources for the OSC. The values are:</p> <table border="1"> <thead> <tr> <th>Value</th> <th>Input Source</th> </tr> </thead> <tbody> <tr><td>0x0</td><td>Main oscillator (default)</td></tr> <tr><td>0x1</td><td>Internal oscillator (default)</td></tr> <tr><td>0x2</td><td>Internal oscillator / 4 (this is necessary if used as input to PLL)</td></tr> <tr><td>0x3</td><td>reserved</td></tr> </tbody> </table>	Value	Input Source	0x0	Main oscillator (default)	0x1	Internal oscillator (default)	0x2	Internal oscillator / 4 (this is necessary if used as input to PLL)	0x3	reserved																																									
Value	Input Source																																																						
0x0	Main oscillator (default)																																																						
0x1	Internal oscillator (default)																																																						
0x2	Internal oscillator / 4 (this is necessary if used as input to PLL)																																																						
0x3	reserved																																																						
3:2	reserved	RO	0x0	Software should not rely on the value of a reserved bit. To provide compatibility with future products, the value of a reserved bit should be preserved across a read-modify-write operation.																																																			
1	IOSCDIS	R/W	0	<p>Internal Oscillator Disable</p> <p>0: Internal oscillator (IOSC) is enabled. 1: Internal oscillator is disabled.</p>																																																			
0	MOSCDIS	R/W	1	<p>Main Oscillator Disable</p> <p>0: Main oscillator is enabled. 1: Main oscillator is disabled (default).</p>																																																			

Register 9: XTAL to PLL Translation (PLLCFG), offset 0x064

This register provides a means of translating external crystal frequencies into the appropriate PLL settings. This register is initialized during the reset sequence and updated anytime that the `XTAL` field changes in the **Run-Mode Clock Configuration (RCC)** register (see page 71).

The PLL frequency is calculated using the **PLLCFG** field values, as follows:

$$\text{PLLFreq} = \text{OSCFreq} * F / (R + 1)$$

XTAL to PLL Translation (PLLCFG)

Base 0x400F.E000

Offset 0x064

Type RO, reset -

	31	30	29	28	27	26	25	24	23	22	21	20	19	18	17	16
	reserved															
Type	RO	RO	RO	RO	RO	RO	RO	RO	RO	RO	RO	RO	RO	RO	RO	RO
Reset	0	0	0	0	0	0	0	0	0	0	0	0	0	0	0	0
	15	14	13	12	11	10	9	8	7	6	5	4	3	2	1	0
	reserved		F										R			
Type	RO	RO	RO	RO	RO	RO	RO	RO	RO	RO	RO	RO	RO	RO	RO	RO
Reset	0	0	-	-	-	-	-	-	-	-	-	-	-	-	-	-

Bit/Field	Name	Type	Reset	Description
31:14	reserved	RO	0x0	Software should not rely on the value of a reserved bit. To provide compatibility with future products, the value of a reserved bit should be preserved across a read-modify-write operation.
13:5	F	RO	-	PLL F Value This field specifies the value supplied to the PLL's F input.
4:0	R	RO	-	PLL R Value This field specifies the value supplied to the PLL's R input.

Register 10: Run-Mode Clock Configuration 2 (RCC2), offset 0x070

This register overrides the **RCC** equivalent register fields when the `USERCC2` bit is set. This allows **RCC2** to be used to extend the capabilities, while also providing a means to be backward-compatible to previous parts. The fields within the **RCC2** register occupy the same bit positions as they do within the **RCC** register as LSB-justified.

The `SYSDIV2` field is wider so that additional larger divisors are possible. This allows a lower system clock frequency for improved Deep Sleep power consumption.

Run-Mode Clock Configuration 2 (RCC2)

Base 0x400F.E000
 Offset 0x070
 Type R/W, reset 0x0780.2800

	31	30	29	28	27	26	25	24	23	22	21	20	19	18	17	16
	USERCC2	reserved			SYSDIV2						reserved					
Type	R/W	RO	RO	R/W	R/W	R/W	R/W	R/W	R/W	RO	RO	RO	RO	RO	RO	RO
Reset	0	0	0	0	0	1	1	1	1	0	0	0	0	0	0	0
	15	14	13	12	11	10	9	8	7	6	5	4	3	2	1	0
	reserved		PWRDN2	reserved	BYPASS2	reserved				OSCSRC2			reserved			
Type	RO	RO	R/W	RO	R/W	RO	RO	RO	RO	R/W	R/W	R/W	RO	RO	RO	RO
Reset	0	0	1	0	1	0	0	0	0	0	0	0	0	0	0	0

Bit/Field	Name	Type	Reset	Description
31	USERCC2	R/W	0	Use RCC2 When set, overrides the RCC register fields.
30:29	reserved	RO	0x0	Software should not rely on the value of a reserved bit. To provide compatibility with future products, the value of a reserved bit should be preserved across a read-modify-write operation.
28:23	SYSDIV2	R/W	0x0F	System Clock Divisor Specifies which divisor is used to generate the system clock from the PLL output. The PLL VCO frequency is 400 MHz. This field is wider than the RCC register <code>SYSDIV</code> field in order to provide additional divisor values. This permits the system clock to be run at much lower frequencies during Deep Sleep mode. For example, where the RCC register <code>SYSDIV</code> encoding of 1111 provides /16, the RCC2 register <code>SYSDIV2</code> encoding of 111111 provides /64.
22:14	reserved	RO	0x0	Software should not rely on the value of a reserved bit. To provide compatibility with future products, the value of a reserved bit should be preserved across a read-modify-write operation.
13	PWRDN2	R/W	1	Power-Down PLL When set, powers down the PLL.
12	reserved	RO	0	Software should not rely on the value of a reserved bit. To provide compatibility with future products, the value of a reserved bit should be preserved across a read-modify-write operation.
11	BYPASS2	R/W	1	Bypass PLL When set, bypasses the PLL for the clock source.

Bit/Field	Name	Type	Reset	Description												
10:7	reserved	RO	0x0	Software should not rely on the value of a reserved bit. To provide compatibility with future products, the value of a reserved bit should be preserved across a read-modify-write operation.												
6:4	OSCSRC2	R/W	0x0	System Clock Source <table border="1"> <thead> <tr> <th>Value</th> <th>Description</th> </tr> </thead> <tbody> <tr> <td>0x0</td> <td>Main oscillator (MOSC)</td> </tr> <tr> <td>0x1</td> <td>Internal oscillator (IOSC)</td> </tr> <tr> <td>0x2</td> <td>Internal oscillator / 4</td> </tr> <tr> <td>0x3</td> <td>30 kHz internal oscillator</td> </tr> <tr> <td>0x7</td> <td>32 kHz external oscillator</td> </tr> </tbody> </table>	Value	Description	0x0	Main oscillator (MOSC)	0x1	Internal oscillator (IOSC)	0x2	Internal oscillator / 4	0x3	30 kHz internal oscillator	0x7	32 kHz external oscillator
Value	Description															
0x0	Main oscillator (MOSC)															
0x1	Internal oscillator (IOSC)															
0x2	Internal oscillator / 4															
0x3	30 kHz internal oscillator															
0x7	32 kHz external oscillator															
3:0	reserved	RO	0	Software should not rely on the value of a reserved bit. To provide compatibility with future products, the value of a reserved bit should be preserved across a read-modify-write operation.												

Register 11: Deep Sleep Clock Configuration (DSLPCCLKCFG), offset 0x144

This register provides configuration information for the hardware control of Deep Sleep Mode.

Deep Sleep Clock Configuration (DSLPCCLKCFG)

Base 0x400F.E000
 Offset 0x144
 Type R/W, reset 0x0780.0000

	31	30	29	28	27	26	25	24	23	22	21	20	19	18	17	16
	reserved			DSDIVORIDE						reserved						
Type	RO	RO	RO	R/W	R/W	R/W	R/W	R/W	R/W	RO	RO	RO	RO	RO	RO	RO
Reset	0	0	0	0	0	1	1	1	1	0	0	0	0	0	0	0
	15	14	13	12	11	10	9	8	7	6	5	4	3	2	1	0
	reserved										DSOSCSRC		reserved			
Type	RO	RO	RO	RO	RO	RO	RO	RO	RO	R/W	R/W	R/W	RO	RO	RO	RO
Reset	0	0	0	0	0	0	0	0	0	0	0	0	0	0	0	0

Bit/Field	Name	Type	Reset	Description															
31:29	reserved	RO	0x0	Software should not rely on the value of a reserved bit. To provide compatibility with future products, the value of a reserved bit should be preserved across a read-modify-write operation.															
28:23	DSDIVORIDE	R/W	0x0F	Divider Field Override 6-bit system divider field to override when Deep-Sleep occurs with PLL running.															
22:7	reserved	RO	0x0	Software should not rely on the value of a reserved bit. To provide compatibility with future products, the value of a reserved bit should be preserved across a read-modify-write operation.															
6:4	DSOSCSRC	R/W	0x0	Clock Source When set, forces IOSC to be clock source during Deep Sleep mode. <table border="1"> <thead> <tr> <th>Value</th> <th>Name</th> <th>Description</th> </tr> </thead> <tbody> <tr> <td>0x0</td> <td>NOORIDE</td> <td>No override to the oscillator clock source is done</td> </tr> <tr> <td>0x1</td> <td>IOSC</td> <td>Use internal 12 MHz oscillator as source</td> </tr> <tr> <td>0x3</td> <td>30kHz</td> <td>Use 30 kHz internal oscillator</td> </tr> <tr> <td>0x7</td> <td>32kHz</td> <td>Use 32 kHz external oscillator</td> </tr> </tbody> </table>	Value	Name	Description	0x0	NOORIDE	No override to the oscillator clock source is done	0x1	IOSC	Use internal 12 MHz oscillator as source	0x3	30kHz	Use 30 kHz internal oscillator	0x7	32kHz	Use 32 kHz external oscillator
Value	Name	Description																	
0x0	NOORIDE	No override to the oscillator clock source is done																	
0x1	IOSC	Use internal 12 MHz oscillator as source																	
0x3	30kHz	Use 30 kHz internal oscillator																	
0x7	32kHz	Use 32 kHz external oscillator																	
3:0	reserved	RO	0x0	Software should not rely on the value of a reserved bit. To provide compatibility with future products, the value of a reserved bit should be preserved across a read-modify-write operation.															

Register 12: Device Identification 1 (DID1), offset 0x004

This register identifies the device family, part number, temperature range, pin count, and package type.

Device Identification 1 (DID1)

Base 0x400F.E000

Offset 0x004

Type RO, reset -

	31	30	29	28	27	26	25	24	23	22	21	20	19	18	17	16
	VER				FAM				PARTNO							
Type	RO	RO	RO	RO	RO	RO	RO	RO	RO	RO	RO	RO	RO	RO	RO	RO
Reset	0	0	0	1	0	0	0	0	1	1	0	1	0	0	1	1
	15	14	13	12	11	10	9	8	7	6	5	4	3	2	1	0
	PINCOUNT			reserved				TEMP			PKG		ROHS	QUAL		
Type	RO	RO	RO	RO	RO	RO	RO	RO	RO	RO	RO	RO	RO	RO	RO	RO
Reset	0	1	0	0	0	0	0	0	0	0	1	0	1	1	-	-

Bit/Field	Name	Type	Reset	Description				
31:28	VER	RO	0x1	<p>DID1 Version</p> <p>This field defines the DID1 register format version. The version number is numeric. The value of the <code>VER</code> field is encoded as follows (all other encodings are reserved):</p> <table border="1"> <thead> <tr> <th>Value</th> <th>Description</th> </tr> </thead> <tbody> <tr> <td>0x1</td> <td>First revision of the DID1 register format, indicating a Stellaris Fury-class device.</td> </tr> </tbody> </table>	Value	Description	0x1	First revision of the DID1 register format, indicating a Stellaris Fury-class device.
Value	Description							
0x1	First revision of the DID1 register format, indicating a Stellaris Fury-class device.							
27:24	FAM	RO	0x0	<p>Family</p> <p>This field provides the family identification of the device within the Luminary Micro product portfolio. The value is encoded as follows (all other encodings are reserved):</p> <table border="1"> <thead> <tr> <th>Value</th> <th>Description</th> </tr> </thead> <tbody> <tr> <td>0x0</td> <td>Stellaris family of microcontrollers, that is, all devices with external part numbers starting with LM3S.</td> </tr> </tbody> </table>	Value	Description	0x0	Stellaris family of microcontrollers, that is, all devices with external part numbers starting with LM3S.
Value	Description							
0x0	Stellaris family of microcontrollers, that is, all devices with external part numbers starting with LM3S.							
23:16	PARTNO	RO	0xD3	<p>Part Number</p> <p>This field provides the part number of the device within the family. The value is encoded as follows (all other encodings are reserved):</p> <table border="1"> <thead> <tr> <th>Value</th> <th>Description</th> </tr> </thead> <tbody> <tr> <td>0xD3</td> <td>LM3S6916</td> </tr> </tbody> </table>	Value	Description	0xD3	LM3S6916
Value	Description							
0xD3	LM3S6916							
15:13	PINCOUNT	RO	0x2	<p>Package Pin Count</p> <p>This field specifies the number of pins on the device package. The value is encoded as follows (all other encodings are reserved):</p> <table border="1"> <thead> <tr> <th>Value</th> <th>Description</th> </tr> </thead> <tbody> <tr> <td>0x2</td> <td>100-pin package</td> </tr> </tbody> </table>	Value	Description	0x2	100-pin package
Value	Description							
0x2	100-pin package							

Bit/Field	Name	Type	Reset	Description
12:8	reserved	RO	0	Software should not rely on the value of a reserved bit. To provide compatibility with future products, the value of a reserved bit should be preserved across a read-modify-write operation.
7:5	TEMP	RO	0x1	Temperature Range This field specifies the temperature rating of the device. The value is encoded as follows (all other encodings are reserved): Value Description 0x1 Industrial temperature range (-40°C to 85°C)
4:3	PKG	RO	0x1	Package Type This field specifies the package type. The value is encoded as follows (all other encodings are reserved): Value Description 0x1 LQFP package
2	ROHS	RO	1	RoHS-Compliance This bit specifies whether the device is RoHS-compliant. A 1 indicates the part is RoHS-compliant.
1:0	QUAL	RO	-	Qualification Status This field specifies the qualification status of the device. The value is encoded as follows (all other encodings are reserved): Value Description 0x0 Engineering Sample (unqualified) 0x1 Pilot Production (unqualified) 0x2 Fully Qualified

Register 13: Device Capabilities 0 (DC0), offset 0x008

This register is predefined by the part and can be used to verify features.

Device Capabilities 0 (DC0)

Base 0x400F.E000

Offset 0x008

Type RO, reset 0x00FF.007F

	31	30	29	28	27	26	25	24	23	22	21	20	19	18	17	16
	SRAMSZ															
Type	RO	RO	RO	RO	RO	RO	RO	RO	RO	RO	RO	RO	RO	RO	RO	RO
Reset	0	0	0	0	0	0	0	0	1	1	1	1	1	1	1	1
	15	14	13	12	11	10	9	8	7	6	5	4	3	2	1	0
	FLASHSZ															
Type	RO	RO	RO	RO	RO	RO	RO	RO	RO	RO	RO	RO	RO	RO	RO	RO
Reset	0	0	0	0	0	0	0	0	0	1	1	1	1	1	1	1

Bit/Field	Name	Type	Reset	Description
31:16	SRAMSZ	RO	0x00FF	SRAM Size Indicates the size of the on-chip SRAM memory. Value Description 0x00FF 64 KB of SRAM
15:0	FLASHSZ	RO	0x007F	Flash Size Indicates the size of the on-chip flash memory. Value Description 0x007F 256 KB of Flash

Register 14: Device Capabilities 1 (DC1), offset 0x010

This register provides a list of features available in the system. The Stellaris family uses this register format to indicate the availability of the following family features in the specific device: CANs, PWM, ADC, Watchdog timer, Hibernation module, and debug capabilities. This register also indicates the maximum clock frequency and maximum ADC sample rate. The format of this register is consistent with the **RCGC0**, **SCGC0**, and **DCGC0** clock control registers and the **SRCR0** software reset control register.

Device Capabilities 1 (DC1)

Base 0x400F.E000
 Offset 0x010
 Type RO, reset 0x0011.32DF

	31	30	29	28	27	26	25	24	23	22	21	20	19	18	17	16
	reserved											PWM	reserved			ADC
Type	RO	RO	RO	RO	RO	RO	RO	RO	RO	RO	RO	RO	RO	RO	RO	RO
Reset	0	0	0	0	0	0	0	0	0	0	0	1	0	0	0	1
	15	14	13	12	11	10	9	8	7	6	5	4	3	2	1	0
	MINSYSDIV				MAXADCSPD				MPU	HIB	reserved	PLL	WDT	SWO	SWD	JTAG
Type	RO	RO	RO	RO	RO	RO	RO	RO	RO	RO	RO	RO	RO	RO	RO	RO
Reset	0	0	1	1	0	0	1	0	1	1	0	1	1	1	1	1

Bit/Field	Name	Type	Reset	Description
31:21	reserved	RO	0	Software should not rely on the value of a reserved bit. To provide compatibility with future products, the value of a reserved bit should be preserved across a read-modify-write operation.
20	PWM	RO	1	PWM Module Present When set, indicates that the PWM module is present.
19:17	reserved	RO	0	Software should not rely on the value of a reserved bit. To provide compatibility with future products, the value of a reserved bit should be preserved across a read-modify-write operation.
16	ADC	RO	1	ADC Module Present When set, indicates that the ADC module is present.
15:12	MINSYSDIV	RO	0x3	System Clock Divider Minimum 4-bit divider value for system clock. The reset value is hardware-dependent. See the RCC register for how to change the system clock divisor using the <i>SYSDIV</i> bit. Value Description 0x3 Specifies a 50-MHz CPU clock with a PLL divider of 4.
11:8	MAXADCSPD	RO	0x2	Max ADC Speed Indicates the maximum rate at which the ADC samples data. Value Description 0x2 500K samples/second

Bit/Field	Name	Type	Reset	Description
7	MPU	RO	1	<p>MPU Present</p> <p>When set, indicates that the Cortex-M3 Memory Protection Unit (MPU) module is present. See the ARM Cortex-M3 Technical Reference Manual for details on the MPU.</p>
6	HIB	RO	1	<p>Hibernation Module Present</p> <p>When set, indicates that the Hibernation module is present.</p>
5	reserved	RO	0	<p>Software should not rely on the value of a reserved bit. To provide compatibility with future products, the value of a reserved bit should be preserved across a read-modify-write operation.</p>
4	PLL	RO	1	<p>PLL Present</p> <p>When set, indicates that the on-chip Phase Locked Loop (PLL) is present.</p>
3	WDT	RO	1	<p>Watchdog Timer Present</p> <p>When set, indicates that a watchdog timer is present.</p>
2	SWO	RO	1	<p>SWO Trace Port Present</p> <p>When set, indicates that the Serial Wire Output (SWO) trace port is present.</p>
1	SWD	RO	1	<p>SWD Present</p> <p>When set, indicates that the Serial Wire Debugger (SWD) is present.</p>
0	JTAG	RO	1	<p>JTAG Present</p> <p>When set, indicates that the JTAG debugger interface is present.</p>

Register 15: Device Capabilities 2 (DC2), offset 0x014

This register provides a list of features available in the system. The Stellaris family uses this register format to indicate the availability of the following family features in the specific device: Analog Comparators, General-Purpose Timers, I2Cs, QEIs, SSIs, and UARTs. The format of this register is consistent with the **RCGC1**, **SCGC1**, and **DCGC1** clock control registers and the **SRCR1** software reset control register.

Device Capabilities 2 (DC2)

Base 0x400F.E000

Offset 0x014

Type RO, reset 0x000F.1017

	31	30	29	28	27	26	25	24	23	22	21	20	19	18	17	16
	reserved												TIMER3	TIMER2	TIMER1	TIMER0
Type	RO	RO	RO	RO	RO	RO	RO	RO	RO	RO	RO	RO	RO	RO	RO	RO
Reset	0	0	0	0	0	0	0	0	0	0	0	0	1	1	1	1
	15	14	13	12	11	10	9	8	7	6	5	4	3	2	1	0
	reserved		I2C0	reserved								SSI0	reserved	UART2	UART1	UART0
Type	RO	RO	RO	RO	RO	RO	RO	RO	RO	RO	RO	RO	RO	RO	RO	RO
Reset	0	0	0	1	0	0	0	0	0	0	0	1	0	1	1	1

Bit/Field	Name	Type	Reset	Description
31:20	reserved	RO	0	Software should not rely on the value of a reserved bit. To provide compatibility with future products, the value of a reserved bit should be preserved across a read-modify-write operation.
19	TIMER3	RO	1	Timer 3 Present When set, indicates that General-Purpose Timer module 3 is present.
18	TIMER2	RO	1	Timer 2 Present When set, indicates that General-Purpose Timer module 2 is present.
17	TIMER1	RO	1	Timer 1 Present When set, indicates that General-Purpose Timer module 1 is present.
16	TIMER0	RO	1	Timer 0 Present When set, indicates that General-Purpose Timer module 0 is present.
15:13	reserved	RO	0	Software should not rely on the value of a reserved bit. To provide compatibility with future products, the value of a reserved bit should be preserved across a read-modify-write operation.
12	I2C0	RO	1	I2C Module 0 Present When set, indicates that I2C module 0 is present.
11:5	reserved	RO	0	Software should not rely on the value of a reserved bit. To provide compatibility with future products, the value of a reserved bit should be preserved across a read-modify-write operation.
4	SSI0	RO	1	SSI0 Present When set, indicates that SSI module 0 is present.

Bit/Field	Name	Type	Reset	Description
3	reserved	RO	0	Software should not rely on the value of a reserved bit. To provide compatibility with future products, the value of a reserved bit should be preserved across a read-modify-write operation.
2	UART2	RO	1	UART2 Present When set, indicates that UART module 2 is present.
1	UART1	RO	1	UART1 Present When set, indicates that UART module 1 is present.
0	UART0	RO	1	UART0 Present When set, indicates that UART module 0 is present.

Register 16: Device Capabilities 3 (DC3), offset 0x018

This register provides a list of features available in the system. The Stellaris family uses this register format to indicate the availability of the following family features in the specific device: Analog Comparator I/Os, CCP I/Os, ADC I/Os, and PWM I/Os.

Device Capabilities 3 (DC3)

Base 0x400F.E000
 Offset 0x018
 Type RO, reset 0x3F3F.8003

	31	30	29	28	27	26	25	24	23	22	21	20	19	18	17	16
	reserved		CCP5	CCP4	CCP3	CCP2	CCP1	CCP0	reserved		ADC5	ADC4	ADC3	ADC2	ADC1	ADC0
Type	RO	RO	RO	RO	RO	RO	RO	RO	RO	RO	RO	RO	RO	RO	RO	RO
Reset	0	0	1	1	1	1	1	1	0	0	1	1	1	1	1	1
	15	14	13	12	11	10	9	8	7	6	5	4	3	2	1	0
	PWMFAULT	reserved													PWM1	PWM0
Type	RO	RO	RO	RO	RO	RO	RO	RO	RO	RO	RO	RO	RO	RO	RO	RO
Reset	1	0	0	0	0	0	0	0	0	0	0	0	0	0	1	1

Bit/Field	Name	Type	Reset	Description
31:30	reserved	RO	0	Software should not rely on the value of a reserved bit. To provide compatibility with future products, the value of a reserved bit should be preserved across a read-modify-write operation.
29	CCP5	RO	1	CCP5 Pin Present When set, indicates that Capture/Compare/PWM pin 5 is present.
28	CCP4	RO	1	CCP4 Pin Present When set, indicates that Capture/Compare/PWM pin 4 is present.
27	CCP3	RO	1	CCP3 Pin Present When set, indicates that Capture/Compare/PWM pin 3 is present.
26	CCP2	RO	1	CCP2 Pin Present When set, indicates that Capture/Compare/PWM pin 2 is present.
25	CCP1	RO	1	CCP1 Pin Present When set, indicates that Capture/Compare/PWM pin 1 is present.
24	CCP0	RO	1	CCP0 Pin Present When set, indicates that Capture/Compare/PWM pin 0 is present.
23:22	reserved	RO	0	Software should not rely on the value of a reserved bit. To provide compatibility with future products, the value of a reserved bit should be preserved across a read-modify-write operation.
21	ADC5	RO	1	ADC5 Pin Present When set, indicates that ADC pin 5 is present.
20	ADC4	RO	1	ADC4 Pin Present When set, indicates that ADC pin 4 is present.

Bit/Field	Name	Type	Reset	Description
19	ADC3	RO	1	ADC3 Pin Present When set, indicates that ADC pin 3 is present.
18	ADC2	RO	1	ADC2 Pin Present When set, indicates that ADC pin 2 is present.
17	ADC1	RO	1	ADC1 Pin Present When set, indicates that ADC pin 1 is present.
16	ADC0	RO	1	ADC0 Pin Present When set, indicates that ADC pin 0 is present.
15	PWMFAULT	RO	1	PWM Fault Pin Present When set, indicates that the PWM Fault pin is present.
14:2	reserved	RO	0	Software should not rely on the value of a reserved bit. To provide compatibility with future products, the value of a reserved bit should be preserved across a read-modify-write operation.
1	PWM1	RO	1	PWM1 Pin Present When set, indicates that the PWM pin 1 is present.
0	PWM0	RO	1	PWM0 Pin Present When set, indicates that the PWM pin 0 is present.

Register 17: Device Capabilities 4 (DC4), offset 0x01C

This register provides a list of features available in the system. The Stellaris family uses this register format to indicate the availability of the following family features in the specific device: Ethernet MAC and PHY, GPIOs, and CCP I/Os. The format of this register is consistent with the **RCGC2**, **SCGC2**, and **DCGC2** clock control registers and the **SRCR2** software reset control register.

Device Capabilities 4 (DC4)

Base 0x400F.E000
 Offset 0x01C
 Type RO, reset 0x5000.007F

	31	30	29	28	27	26	25	24	23	22	21	20	19	18	17	16	
	reserved	EPHY0	reserved	EMAC0	reserved												
Type	RO	RO	RO	RO	RO	RO	RO	RO	RO	RO	RO	RO	RO	RO	RO	RO	
Reset	0	1	0	1	0	0	0	0	0	0	0	0	0	0	0	0	
	15	14	13	12	11	10	9	8	7	6	5	4	3	2	1	0	
	reserved										GPIOG	GPIOF	GPIOE	GPIOD	GPIOC	GPIOB	GPIOA
Type	RO	RO	RO	RO	RO	RO	RO	RO	RO	RO	RO	RO	RO	RO	RO	RO	
Reset	0	0	0	0	0	0	0	0	0	0	1	1	1	1	1	1	

Bit/Field	Name	Type	Reset	Description
31	reserved	RO	0	Software should not rely on the value of a reserved bit. To provide compatibility with future products, the value of a reserved bit should be preserved across a read-modify-write operation.
30	EPHY0	RO	1	Ethernet PHY0 Present When set, indicates that Ethernet PHY module 0 is present.
29	reserved	RO	0	Software should not rely on the value of a reserved bit. To provide compatibility with future products, the value of a reserved bit should be preserved across a read-modify-write operation.
28	EMAC0	RO	1	Ethernet MAC0 Present When set, indicates that Ethernet MAC module 0 is present.
27:7	reserved	RO	0	Software should not rely on the value of a reserved bit. To provide compatibility with future products, the value of a reserved bit should be preserved across a read-modify-write operation.
6	GPIOG	RO	1	GPIO Port G Present When set, indicates that GPIO Port G is present.
5	GPIOF	RO	1	GPIO Port F Present When set, indicates that GPIO Port F is present.
4	GPIOE	RO	1	GPIO Port E Present When set, indicates that GPIO Port E is present.
3	GPIOD	RO	1	GPIO Port D Present When set, indicates that GPIO Port D is present.
2	GPIOC	RO	1	GPIO Port C Present When set, indicates that GPIO Port C is present.

Bit/Field	Name	Type	Reset	Description
1	GPIOB	RO	1	GPIO Port B Present When set, indicates that GPIO Port B is present.
0	GPIOA	RO	1	GPIO Port A Present When set, indicates that GPIO Port A is present.

Register 18: Run Mode Clock Gating Control Register 0 (RCGC0), offset 0x100

This register controls the clock gating logic. Each bit controls a clock enable for a given interface, function, or unit. If set, the unit receives a clock and functions. Otherwise, the unit is unclocked and disabled (saving power). If the unit is unclocked, reads or writes to the unit will generate a bus fault. The reset state of these bits is 0 (unclocked) unless otherwise noted, so that all functional units are disabled. It is the responsibility of software to enable the ports necessary for the application. Note that these registers may contain more bits than there are interfaces, functions, or units to control. This is to assure reasonable code compatibility with other family and future parts. **RCGC0** is the clock configuration register for running operation, **SCGC0** for Sleep operation, and **DCGC0** for Deep-Sleep operation. Setting the **ACG** bit in the **Run-Mode Clock Configuration (RCC)** register specifies that the system uses sleep modes.

Run Mode Clock Gating Control Register 0 (RCGC0)

Base 0x400F.E000
 Offset 0x100
 Type R/W, reset 0x00000040

	31	30	29	28	27	26	25	24	23	22	21	20	19	18	17	16
	reserved											PWM	reserved			ADC
Type	RO	RO	RO	RO	RO	RO	RO	RO	RO	RO	RO	R/W	RO	RO	RO	R/W
Reset	0	0	0	0	0	0	0	0	0	0	0	0	0	0	0	0
	15	14	13	12	11	10	9	8	7	6	5	4	3	2	1	0
	reserved				MAXADCSPD			reserved	HIB	reserved	WDT	reserved				
Type	RO	RO	RO	RO	R/W	R/W	R/W	R/W	RO	R/W	RO	RO	R/W	RO	RO	RO
Reset	0	0	0	0	0	0	0	0	0	0	0	0	0	0	0	0

Bit/Field	Name	Type	Reset	Description
31:21	reserved	RO	0	Software should not rely on the value of a reserved bit. To provide compatibility with future products, the value of a reserved bit should be preserved across a read-modify-write operation.
20	PWM	R/W	0	<p>PWM Clock Gating Control</p> <p>This bit controls the clock gating for the PWM module. If set, the unit receives a clock and functions. Otherwise, the unit is unclocked and disabled. If the unit is unclocked, a read or write to the unit generates a bus fault.</p>
19:17	reserved	RO	0	Software should not rely on the value of a reserved bit. To provide compatibility with future products, the value of a reserved bit should be preserved across a read-modify-write operation.
16	ADC	R/W	0	<p>ADC0 Clock Gating Control</p> <p>This bit controls the clock gating for SAR ADC module 0. If set, the unit receives a clock and functions. Otherwise, the unit is unclocked and disabled. If the unit is unclocked, a read or write to the unit generates a bus fault.</p>
15:12	reserved	RO	0	Software should not rely on the value of a reserved bit. To provide compatibility with future products, the value of a reserved bit should be preserved across a read-modify-write operation.

Bit/Field	Name	Type	Reset	Description								
11:8	MAXADCSPD	R/W	0	<p>ADC Sample Speed</p> <p>This field sets the rate at which the ADC samples data. You cannot set the rate higher than the maximum rate. You can set the sample rate by setting the MAXADCSPD bit as follows:</p> <table border="1"> <thead> <tr> <th>Value</th> <th>Description</th> </tr> </thead> <tbody> <tr> <td>0x2</td> <td>500K samples/second</td> </tr> <tr> <td>0x1</td> <td>250K samples/second</td> </tr> <tr> <td>0x0</td> <td>125K samples/second</td> </tr> </tbody> </table>	Value	Description	0x2	500K samples/second	0x1	250K samples/second	0x0	125K samples/second
Value	Description											
0x2	500K samples/second											
0x1	250K samples/second											
0x0	125K samples/second											
7	reserved	RO	0	Software should not rely on the value of a reserved bit. To provide compatibility with future products, the value of a reserved bit should be preserved across a read-modify-write operation.								
6	HIB	R/W	0	<p>HIB Clock Gating Control</p> <p>This bit controls the clock gating for the Hibernation module. If set, the unit receives a clock and functions. Otherwise, the unit is unlocked and disabled.</p>								
5:4	reserved	RO	0	Software should not rely on the value of a reserved bit. To provide compatibility with future products, the value of a reserved bit should be preserved across a read-modify-write operation.								
3	WDT	R/W	0	<p>WDT Clock Gating Control</p> <p>This bit controls the clock gating for the WDT module. If set, the unit receives a clock and functions. Otherwise, the unit is unlocked and disabled. If the unit is unlocked, a read or write to the unit generates a bus fault.</p>								
2:0	reserved	RO	0	Software should not rely on the value of a reserved bit. To provide compatibility with future products, the value of a reserved bit should be preserved across a read-modify-write operation.								

Register 19: Sleep Mode Clock Gating Control Register 0 (SCGC0), offset 0x110

This register controls the clock gating logic. Each bit controls a clock enable for a given interface, function, or unit. If set, the unit receives a clock and functions. Otherwise, the unit is unlocked and disabled (saving power). If the unit is unlocked, reads or writes to the unit will generate a bus fault. The reset state of these bits is 0 (unlocked) unless otherwise noted, so that all functional units are disabled. It is the responsibility of software to enable the ports necessary for the application. Note that these registers may contain more bits than there are interfaces, functions, or units to control. This is to assure reasonable code compatibility with other family and future parts. **RCGC0** is the clock configuration register for running operation, **SCGC0** for Sleep operation, and **DCGC0** for Deep-Sleep operation. Setting the **ACG** bit in the **Run-Mode Clock Configuration (RCC)** register specifies that the system uses sleep modes.

Sleep Mode Clock Gating Control Register 0 (SCGC0)

Base 0x400F.E000
 Offset 0x110
 Type R/W, reset 0x00000040

	31	30	29	28	27	26	25	24	23	22	21	20	19	18	17	16
	reserved											PWM	reserved		ADC	
Type	RO	RO	RO	RO	RO	RO	RO	RO	RO	RO	RO	R/W	RO	RO	RO	R/W
Reset	0	0	0	0	0	0	0	0	0	0	0	0	0	0	0	0
	15	14	13	12	11	10	9	8	7	6	5	4	3	2	1	0
	reserved				MAXADCSPD			reserved	HIB	reserved	WDT	reserved				
Type	RO	RO	RO	RO	R/W	R/W	R/W	R/W	RO	R/W	RO	RO	R/W	RO	RO	RO
Reset	0	0	0	0	0	0	0	0	0	0	0	0	0	0	0	0

Bit/Field	Name	Type	Reset	Description
31:21	reserved	RO	0	Software should not rely on the value of a reserved bit. To provide compatibility with future products, the value of a reserved bit should be preserved across a read-modify-write operation.
20	PWM	R/W	0	<p>PWM Clock Gating Control</p> <p>This bit controls the clock gating for the PWM module. If set, the unit receives a clock and functions. Otherwise, the unit is unlocked and disabled. If the unit is unlocked, a read or write to the unit generates a bus fault.</p>
19:17	reserved	RO	0	Software should not rely on the value of a reserved bit. To provide compatibility with future products, the value of a reserved bit should be preserved across a read-modify-write operation.
16	ADC	R/W	0	<p>ADC0 Clock Gating Control</p> <p>This bit controls the clock gating for SAR ADC module 0. If set, the unit receives a clock and functions. Otherwise, the unit is unlocked and disabled. If the unit is unlocked, a read or write to the unit generates a bus fault.</p>
15:12	reserved	RO	0	Software should not rely on the value of a reserved bit. To provide compatibility with future products, the value of a reserved bit should be preserved across a read-modify-write operation.

Bit/Field	Name	Type	Reset	Description								
11:8	MAXADCSPD	R/W	0	<p>ADC Sample Speed</p> <p>This field sets the rate at which the ADC samples data. You cannot set the rate higher than the maximum rate. You can set the sample rate by setting the MAXADCSPD bit as follows:</p> <table border="1"> <thead> <tr> <th>Value</th> <th>Description</th> </tr> </thead> <tbody> <tr> <td>0x2</td> <td>500K samples/second</td> </tr> <tr> <td>0x1</td> <td>250K samples/second</td> </tr> <tr> <td>0x0</td> <td>125K samples/second</td> </tr> </tbody> </table>	Value	Description	0x2	500K samples/second	0x1	250K samples/second	0x0	125K samples/second
Value	Description											
0x2	500K samples/second											
0x1	250K samples/second											
0x0	125K samples/second											
7	reserved	RO	0	Software should not rely on the value of a reserved bit. To provide compatibility with future products, the value of a reserved bit should be preserved across a read-modify-write operation.								
6	HIB	R/W	0	<p>HIB Clock Gating Control</p> <p>This bit controls the clock gating for the Hibernation module. If set, the unit receives a clock and functions. Otherwise, the unit is unlocked and disabled.</p>								
5:4	reserved	RO	0	Software should not rely on the value of a reserved bit. To provide compatibility with future products, the value of a reserved bit should be preserved across a read-modify-write operation.								
3	WDT	R/W	0	<p>WDT Clock Gating Control</p> <p>This bit controls the clock gating for the WDT module. If set, the unit receives a clock and functions. Otherwise, the unit is unlocked and disabled. If the unit is unlocked, a read or write to the unit generates a bus fault.</p>								
2:0	reserved	RO	0	Software should not rely on the value of a reserved bit. To provide compatibility with future products, the value of a reserved bit should be preserved across a read-modify-write operation.								

Register 20: Deep Sleep Mode Clock Gating Control Register 0 (DCGC0), offset 0x120

This register controls the clock gating logic. Each bit controls a clock enable for a given interface, function, or unit. If set, the unit receives a clock and functions. Otherwise, the unit is unlocked and disabled (saving power). If the unit is unlocked, reads or writes to the unit will generate a bus fault. The reset state of these bits is 0 (unlocked) unless otherwise noted, so that all functional units are disabled. It is the responsibility of software to enable the ports necessary for the application. Note that these registers may contain more bits than there are interfaces, functions, or units to control. This is to assure reasonable code compatibility with other family and future parts. **RCGC0** is the clock configuration register for running operation, **SCGC0** for Sleep operation, and **DCGC0** for Deep-Sleep operation. Setting the **ACG** bit in the **Run-Mode Clock Configuration (RCC)** register specifies that the system uses sleep modes.

Deep Sleep Mode Clock Gating Control Register 0 (DCGC0)

Base 0x400F.E000
 Offset 0x120
 Type R/W, reset 0x00000040

	31	30	29	28	27	26	25	24	23	22	21	20	19	18	17	16
	reserved											PWM	reserved			ADC
Type	RO	RO	RO	RO	RO	RO	RO	RO	RO	RO	RO	R/W	RO	RO	RO	R/W
Reset	0	0	0	0	0	0	0	0	0	0	0	0	0	0	0	0
	15	14	13	12	11	10	9	8	7	6	5	4	3	2	1	0
	reserved				MAXADCSPD				reserved	HIB	reserved	WDT	reserved			
Type	RO	RO	RO	RO	R/W	R/W	R/W	R/W	RO	R/W	RO	RO	R/W	RO	RO	RO
Reset	0	0	0	0	0	0	0	0	0	0	0	0	0	0	0	0

Bit/Field	Name	Type	Reset	Description
31:21	reserved	RO	0	Software should not rely on the value of a reserved bit. To provide compatibility with future products, the value of a reserved bit should be preserved across a read-modify-write operation.
20	PWM	R/W	0	<p>PWM Clock Gating Control</p> <p>This bit controls the clock gating for the PWM module. If set, the unit receives a clock and functions. Otherwise, the unit is unlocked and disabled. If the unit is unlocked, a read or write to the unit generates a bus fault.</p>
19:17	reserved	RO	0	Software should not rely on the value of a reserved bit. To provide compatibility with future products, the value of a reserved bit should be preserved across a read-modify-write operation.
16	ADC	R/W	0	<p>ADC0 Clock Gating Control</p> <p>This bit controls the clock gating for SAR ADC module 0. If set, the unit receives a clock and functions. Otherwise, the unit is unlocked and disabled. If the unit is unlocked, a read or write to the unit generates a bus fault.</p>
15:12	reserved	RO	0	Software should not rely on the value of a reserved bit. To provide compatibility with future products, the value of a reserved bit should be preserved across a read-modify-write operation.

Bit/Field	Name	Type	Reset	Description								
11:8	MAXADCSPD	R/W	0	<p>ADC Sample Speed</p> <p>This field sets the rate at which the ADC samples data. You cannot set the rate higher than the maximum rate. You can set the sample rate by setting the MAXADCSPD bit as follows:</p> <table border="1"> <thead> <tr> <th>Value</th> <th>Description</th> </tr> </thead> <tbody> <tr> <td>0x2</td> <td>500K samples/second</td> </tr> <tr> <td>0x1</td> <td>250K samples/second</td> </tr> <tr> <td>0x0</td> <td>125K samples/second</td> </tr> </tbody> </table>	Value	Description	0x2	500K samples/second	0x1	250K samples/second	0x0	125K samples/second
Value	Description											
0x2	500K samples/second											
0x1	250K samples/second											
0x0	125K samples/second											
7	reserved	RO	0	Software should not rely on the value of a reserved bit. To provide compatibility with future products, the value of a reserved bit should be preserved across a read-modify-write operation.								
6	HIB	R/W	0	<p>HIB Clock Gating Control</p> <p>This bit controls the clock gating for the Hibernation module. If set, the unit receives a clock and functions. Otherwise, the unit is unlocked and disabled.</p>								
5:4	reserved	RO	0	Software should not rely on the value of a reserved bit. To provide compatibility with future products, the value of a reserved bit should be preserved across a read-modify-write operation.								
3	WDT	R/W	0	<p>WDT Clock Gating Control</p> <p>This bit controls the clock gating for the WDT module. If set, the unit receives a clock and functions. Otherwise, the unit is unlocked and disabled. If the unit is unlocked, a read or write to the unit generates a bus fault.</p>								
2:0	reserved	RO	0	Software should not rely on the value of a reserved bit. To provide compatibility with future products, the value of a reserved bit should be preserved across a read-modify-write operation.								

Register 21: Run Mode Clock Gating Control Register 1 (RCGC1), offset 0x104

This register controls the clock gating logic. Each bit controls a clock enable for a given interface, function, or unit. If set, the unit receives a clock and functions. Otherwise, the unit is unclocked and disabled (saving power). If the unit is unclocked, reads or writes to the unit will generate a bus fault. The reset state of these bits is 0 (unclocked) unless otherwise noted, so that all functional units are disabled. It is the responsibility of software to enable the ports necessary for the application. Note that these registers may contain more bits than there are interfaces, functions, or units to control. This is to assure reasonable code compatibility with other family and future parts. **RCGC1** is the clock configuration register for running operation, **SCGC1** for Sleep operation, and **DCGC1** for Deep-Sleep operation. Setting the **ACG** bit in the **Run-Mode Clock Configuration (RCC)** register specifies that the system uses sleep modes.

Run Mode Clock Gating Control Register 1 (RCGC1)

Base 0x400F.E000
 Offset 0x104
 Type R/W, reset 0x00000000

	31	30	29	28	27	26	25	24	23	22	21	20	19	18	17	16
	reserved												TIMER3	TIMER2	TIMER1	TIMER0
Type	RO	RO	RO	RO	RO	RO	RO	RO	RO	RO	RO	RO	R/W	R/W	R/W	R/W
Reset	0	0	0	0	0	0	0	0	0	0	0	0	0	0	0	0
	15	14	13	12	11	10	9	8	7	6	5	4	3	2	1	0
	reserved			I2C0	reserved							SSI0	reserved	UART2	UART1	UART0
Type	RO	RO	RO	R/W	RO	RO	RO	RO	RO	RO	RO	R/W	RO	R/W	R/W	R/W
Reset	0	0	0	0	0	0	0	0	0	0	0	0	0	0	0	0

Bit/Field	Name	Type	Reset	Description
31:20	reserved	RO	0	Software should not rely on the value of a reserved bit. To provide compatibility with future products, the value of a reserved bit should be preserved across a read-modify-write operation.
19	TIMER3	R/W	0	<p>Timer 3 Clock Gating Control</p> <p>This bit controls the clock gating for General-Purpose Timer module 3. If set, the unit receives a clock and functions. Otherwise, the unit is unclocked and disabled. If the unit is unclocked, reads or writes to the unit will generate a bus fault.</p>
18	TIMER2	R/W	0	<p>Timer 2 Clock Gating Control</p> <p>This bit controls the clock gating for General-Purpose Timer module 2. If set, the unit receives a clock and functions. Otherwise, the unit is unclocked and disabled. If the unit is unclocked, reads or writes to the unit will generate a bus fault.</p>
17	TIMER1	R/W	0	<p>Timer 1 Clock Gating Control</p> <p>This bit controls the clock gating for General-Purpose Timer module 1. If set, the unit receives a clock and functions. Otherwise, the unit is unclocked and disabled. If the unit is unclocked, reads or writes to the unit will generate a bus fault.</p>
16	TIMER0	R/W	0	<p>Timer 0 Clock Gating Control</p> <p>This bit controls the clock gating for General-Purpose Timer module 0. If set, the unit receives a clock and functions. Otherwise, the unit is unclocked and disabled. If the unit is unclocked, reads or writes to the unit will generate a bus fault.</p>

Bit/Field	Name	Type	Reset	Description
15:13	reserved	RO	0	Software should not rely on the value of a reserved bit. To provide compatibility with future products, the value of a reserved bit should be preserved across a read-modify-write operation.
12	I2C0	R/W	0	I2C0 Clock Gating Control This bit controls the clock gating for I2C module 0. If set, the unit receives a clock and functions. Otherwise, the unit is unlocked and disabled. If the unit is unlocked, reads or writes to the unit will generate a bus fault.
11:5	reserved	RO	0	Software should not rely on the value of a reserved bit. To provide compatibility with future products, the value of a reserved bit should be preserved across a read-modify-write operation.
4	SSI0	R/W	0	SSI0 Clock Gating Control This bit controls the clock gating for SSI module 0. If set, the unit receives a clock and functions. Otherwise, the unit is unlocked and disabled. If the unit is unlocked, reads or writes to the unit will generate a bus fault.
3	reserved	RO	0	Software should not rely on the value of a reserved bit. To provide compatibility with future products, the value of a reserved bit should be preserved across a read-modify-write operation.
2	UART2	R/W	0	UART2 Clock Gating Control This bit controls the clock gating for UART module 2. If set, the unit receives a clock and functions. Otherwise, the unit is unlocked and disabled. If the unit is unlocked, reads or writes to the unit will generate a bus fault.
1	UART1	R/W	0	UART1 Clock Gating Control This bit controls the clock gating for UART module 1. If set, the unit receives a clock and functions. Otherwise, the unit is unlocked and disabled. If the unit is unlocked, reads or writes to the unit will generate a bus fault.
0	UART0	R/W	0	UART0 Clock Gating Control This bit controls the clock gating for UART module 0. If set, the unit receives a clock and functions. Otherwise, the unit is unlocked and disabled. If the unit is unlocked, reads or writes to the unit will generate a bus fault.

Register 22: Sleep Mode Clock Gating Control Register 1 (SCGC1), offset 0x114

This register controls the clock gating logic. Each bit controls a clock enable for a given interface, function, or unit. If set, the unit receives a clock and functions. Otherwise, the unit is unlocked and disabled (saving power). If the unit is unlocked, reads or writes to the unit will generate a bus fault. The reset state of these bits is 0 (unlocked) unless otherwise noted, so that all functional units are disabled. It is the responsibility of software to enable the ports necessary for the application. Note that these registers may contain more bits than there are interfaces, functions, or units to control. This is to assure reasonable code compatibility with other family and future parts. **RCGC1** is the clock configuration register for running operation, **SCGC1** for Sleep operation, and **DCGC1** for Deep-Sleep operation. Setting the **ACG** bit in the **Run-Mode Clock Configuration (RCC)** register specifies that the system uses sleep modes.

Sleep Mode Clock Gating Control Register 1 (SCGC1)

Base 0x400F.E000

Offset 0x114

Type R/W, reset 0x00000000

	31	30	29	28	27	26	25	24	23	22	21	20	19	18	17	16
	reserved												TIMER3	TIMER2	TIMER1	TIMERO
Type	RO	RO	RO	RO	RO	RO	RO	RO	RO	RO	RO	RO	R/W	R/W	R/W	R/W
Reset	0	0	0	0	0	0	0	0	0	0	0	0	0	0	0	0
	15	14	13	12	11	10	9	8	7	6	5	4	3	2	1	0
	reserved			I2C0	reserved							SSI0	reserved	UART2	UART1	UART0
Type	RO	RO	RO	R/W	RO	RO	RO	RO	RO	RO	RO	R/W	RO	R/W	R/W	R/W
Reset	0	0	0	0	0	0	0	0	0	0	0	0	0	0	0	0

Bit/Field	Name	Type	Reset	Description
31:20	reserved	RO	0	Software should not rely on the value of a reserved bit. To provide compatibility with future products, the value of a reserved bit should be preserved across a read-modify-write operation.
19	TIMER3	R/W	0	Timer 3 Clock Gating Control This bit controls the clock gating for General-Purpose Timer module 3. If set, the unit receives a clock and functions. Otherwise, the unit is unlocked and disabled. If the unit is unlocked, reads or writes to the unit will generate a bus fault.
18	TIMER2	R/W	0	Timer 2 Clock Gating Control This bit controls the clock gating for General-Purpose Timer module 2. If set, the unit receives a clock and functions. Otherwise, the unit is unlocked and disabled. If the unit is unlocked, reads or writes to the unit will generate a bus fault.
17	TIMER1	R/W	0	Timer 1 Clock Gating Control This bit controls the clock gating for General-Purpose Timer module 1. If set, the unit receives a clock and functions. Otherwise, the unit is unlocked and disabled. If the unit is unlocked, reads or writes to the unit will generate a bus fault.

Bit/Field	Name	Type	Reset	Description
16	TIMER0	R/W	0	<p>Timer 0 Clock Gating Control</p> <p>This bit controls the clock gating for General-Purpose Timer module 0. If set, the unit receives a clock and functions. Otherwise, the unit is unlocked and disabled. If the unit is unlocked, reads or writes to the unit will generate a bus fault.</p>
15:13	reserved	RO	0	Software should not rely on the value of a reserved bit. To provide compatibility with future products, the value of a reserved bit should be preserved across a read-modify-write operation.
12	I2C0	R/W	0	<p>I2C0 Clock Gating Control</p> <p>This bit controls the clock gating for I2C module 0. If set, the unit receives a clock and functions. Otherwise, the unit is unlocked and disabled. If the unit is unlocked, reads or writes to the unit will generate a bus fault.</p>
11:5	reserved	RO	0	Software should not rely on the value of a reserved bit. To provide compatibility with future products, the value of a reserved bit should be preserved across a read-modify-write operation.
4	SSI0	R/W	0	<p>SSI0 Clock Gating Control</p> <p>This bit controls the clock gating for SSI module 0. If set, the unit receives a clock and functions. Otherwise, the unit is unlocked and disabled. If the unit is unlocked, reads or writes to the unit will generate a bus fault.</p>
3	reserved	RO	0	Software should not rely on the value of a reserved bit. To provide compatibility with future products, the value of a reserved bit should be preserved across a read-modify-write operation.
2	UART2	R/W	0	<p>UART2 Clock Gating Control</p> <p>This bit controls the clock gating for UART module 2. If set, the unit receives a clock and functions. Otherwise, the unit is unlocked and disabled. If the unit is unlocked, reads or writes to the unit will generate a bus fault.</p>
1	UART1	R/W	0	<p>UART1 Clock Gating Control</p> <p>This bit controls the clock gating for UART module 1. If set, the unit receives a clock and functions. Otherwise, the unit is unlocked and disabled. If the unit is unlocked, reads or writes to the unit will generate a bus fault.</p>
0	UART0	R/W	0	<p>UART0 Clock Gating Control</p> <p>This bit controls the clock gating for UART module 0. If set, the unit receives a clock and functions. Otherwise, the unit is unlocked and disabled. If the unit is unlocked, reads or writes to the unit will generate a bus fault.</p>

Register 23: Deep Sleep Mode Clock Gating Control Register 1 (DCGC1), offset 0x124

This register controls the clock gating logic. Each bit controls a clock enable for a given interface, function, or unit. If set, the unit receives a clock and functions. Otherwise, the unit is unlocked and disabled (saving power). If the unit is unlocked, reads or writes to the unit will generate a bus fault. The reset state of these bits is 0 (unlocked) unless otherwise noted, so that all functional units are disabled. It is the responsibility of software to enable the ports necessary for the application. Note that these registers may contain more bits than there are interfaces, functions, or units to control. This is to assure reasonable code compatibility with other family and future parts. **RCGC1** is the clock configuration register for running operation, **SCGC1** for Sleep operation, and **DCGC1** for Deep-Sleep operation. Setting the **ACG** bit in the **Run-Mode Clock Configuration (RCC)** register specifies that the system uses sleep modes.

Deep Sleep Mode Clock Gating Control Register 1 (DCGC1)

Base 0x400F.E000
 Offset 0x124
 Type R/W, reset 0x00000000

	31	30	29	28	27	26	25	24	23	22	21	20	19	18	17	16
	reserved												TIMER3	TIMER2	TIMER1	TIMER0
Type	RO	RO	RO	RO	RO	RO	RO	RO	RO	RO	RO	RO	R/W	R/W	R/W	R/W
Reset	0	0	0	0	0	0	0	0	0	0	0	0	0	0	0	0
	15	14	13	12	11	10	9	8	7	6	5	4	3	2	1	0
	reserved			I2C0	reserved							SSI0	reserved	UART2	UART1	UART0
Type	RO	RO	RO	R/W	RO	RO	RO	RO	RO	RO	RO	R/W	RO	R/W	R/W	R/W
Reset	0	0	0	0	0	0	0	0	0	0	0	0	0	0	0	0

Bit/Field	Name	Type	Reset	Description
31:20	reserved	RO	0	Software should not rely on the value of a reserved bit. To provide compatibility with future products, the value of a reserved bit should be preserved across a read-modify-write operation.
19	TIMER3	R/W	0	Timer 3 Clock Gating Control This bit controls the clock gating for General-Purpose Timer module 3. If set, the unit receives a clock and functions. Otherwise, the unit is unlocked and disabled. If the unit is unlocked, reads or writes to the unit will generate a bus fault.
18	TIMER2	R/W	0	Timer 2 Clock Gating Control This bit controls the clock gating for General-Purpose Timer module 2. If set, the unit receives a clock and functions. Otherwise, the unit is unlocked and disabled. If the unit is unlocked, reads or writes to the unit will generate a bus fault.
17	TIMER1	R/W	0	Timer 1 Clock Gating Control This bit controls the clock gating for General-Purpose Timer module 1. If set, the unit receives a clock and functions. Otherwise, the unit is unlocked and disabled. If the unit is unlocked, reads or writes to the unit will generate a bus fault.

Bit/Field	Name	Type	Reset	Description
16	TIMER0	R/W	0	<p>Timer 0 Clock Gating Control</p> <p>This bit controls the clock gating for General-Purpose Timer module 0. If set, the unit receives a clock and functions. Otherwise, the unit is unlocked and disabled. If the unit is unlocked, reads or writes to the unit will generate a bus fault.</p>
15:13	reserved	RO	0	<p>Software should not rely on the value of a reserved bit. To provide compatibility with future products, the value of a reserved bit should be preserved across a read-modify-write operation.</p>
12	I2C0	R/W	0	<p>I2C0 Clock Gating Control</p> <p>This bit controls the clock gating for I2C module 0. If set, the unit receives a clock and functions. Otherwise, the unit is unlocked and disabled. If the unit is unlocked, reads or writes to the unit will generate a bus fault.</p>
11:5	reserved	RO	0	<p>Software should not rely on the value of a reserved bit. To provide compatibility with future products, the value of a reserved bit should be preserved across a read-modify-write operation.</p>
4	SSI0	R/W	0	<p>SSI0 Clock Gating Control</p> <p>This bit controls the clock gating for SSI module 0. If set, the unit receives a clock and functions. Otherwise, the unit is unlocked and disabled. If the unit is unlocked, reads or writes to the unit will generate a bus fault.</p>
3	reserved	RO	0	<p>Software should not rely on the value of a reserved bit. To provide compatibility with future products, the value of a reserved bit should be preserved across a read-modify-write operation.</p>
2	UART2	R/W	0	<p>UART2 Clock Gating Control</p> <p>This bit controls the clock gating for UART module 2. If set, the unit receives a clock and functions. Otherwise, the unit is unlocked and disabled. If the unit is unlocked, reads or writes to the unit will generate a bus fault.</p>
1	UART1	R/W	0	<p>UART1 Clock Gating Control</p> <p>This bit controls the clock gating for UART module 1. If set, the unit receives a clock and functions. Otherwise, the unit is unlocked and disabled. If the unit is unlocked, reads or writes to the unit will generate a bus fault.</p>
0	UART0	R/W	0	<p>UART0 Clock Gating Control</p> <p>This bit controls the clock gating for UART module 0. If set, the unit receives a clock and functions. Otherwise, the unit is unlocked and disabled. If the unit is unlocked, reads or writes to the unit will generate a bus fault.</p>

Register 24: Run Mode Clock Gating Control Register 2 (RCGC2), offset 0x108

This register controls the clock gating logic. Each bit controls a clock enable for a given interface, function, or unit. If set, the unit receives a clock and functions. Otherwise, the unit is unlocked and disabled (saving power). If the unit is unlocked, reads or writes to the unit will generate a bus fault. The reset state of these bits is 0 (unlocked) unless otherwise noted, so that all functional units are disabled. It is the responsibility of software to enable the ports necessary for the application. Note that these registers may contain more bits than there are interfaces, functions, or units to control. This is to assure reasonable code compatibility with other family and future parts. **RCGC2** is the clock configuration register for running operation, **SCGC2** for Sleep operation, and **DCGC2** for Deep-Sleep operation. Setting the **ACG** bit in the **Run-Mode Clock Configuration (RCC)** register specifies that the system uses sleep modes.

Run Mode Clock Gating Control Register 2 (RCGC2)

Base 0x400F.E000
 Offset 0x108
 Type R/W, reset 0x00000000

	31	30	29	28	27	26	25	24	23	22	21	20	19	18	17	16	
	reserved	EPHY0	reserved	EMAC0	reserved												
Type	RO	R/W	RO	R/W	RO	RO	RO	RO	RO	RO	RO	RO	RO	RO	RO	RO	
Reset	0	0	0	0	0	0	0	0	0	0	0	0	0	0	0	0	
	15	14	13	12	11	10	9	8	7	6	5	4	3	2	1	0	
	reserved										GPIOG	GPIOF	GPIOE	GPIOD	GPIOC	GPIOB	GPIOA
Type	RO	RO	RO	RO	RO	RO	RO	RO	RO	R/W	R/W	R/W	R/W	R/W	R/W	R/W	
Reset	0	0	0	0	0	0	0	0	0	0	0	0	0	0	0	0	

Bit/Field	Name	Type	Reset	Description
31	reserved	RO	0	Software should not rely on the value of a reserved bit. To provide compatibility with future products, the value of a reserved bit should be preserved across a read-modify-write operation.
30	EPHY0	R/W	0	PHY0 Clock Gating Control This bit controls the clock gating for Ethernet PHY unit 0. If set, the unit receives a clock and functions. Otherwise, the unit is unlocked and disabled. If the unit is unlocked, reads or writes to the unit will generate a bus fault.
29	reserved	RO	0	Software should not rely on the value of a reserved bit. To provide compatibility with future products, the value of a reserved bit should be preserved across a read-modify-write operation.
28	EMAC0	R/W	0	MAC0 Clock Gating Control This bit controls the clock gating for Ethernet MAC unit 0. If set, the unit receives a clock and functions. Otherwise, the unit is unlocked and disabled. If the unit is unlocked, reads or writes to the unit will generate a bus fault.
27:7	reserved	RO	0	Software should not rely on the value of a reserved bit. To provide compatibility with future products, the value of a reserved bit should be preserved across a read-modify-write operation.
6	GPIOG	R/W	0	Port G Clock Gating Control This bit controls the clock gating for Port G. If set, the unit receives a clock and functions. Otherwise, the unit is unlocked and disabled. If the unit is unlocked, reads or writes to the unit will generate a bus fault.

Bit/Field	Name	Type	Reset	Description
5	GPIOF	R/W	0	<p>Port F Clock Gating Control</p> <p>This bit controls the clock gating for Port F. If set, the unit receives a clock and functions. Otherwise, the unit is unlocked and disabled. If the unit is unlocked, reads or writes to the unit will generate a bus fault.</p>
4	GPIOE	R/W	0	<p>Port E Clock Gating Control</p> <p>This bit controls the clock gating for Port E. If set, the unit receives a clock and functions. Otherwise, the unit is unlocked and disabled. If the unit is unlocked, reads or writes to the unit will generate a bus fault.</p>
3	GPIOD	R/W	0	<p>Port D Clock Gating Control</p> <p>This bit controls the clock gating for Port D. If set, the unit receives a clock and functions. Otherwise, the unit is unlocked and disabled. If the unit is unlocked, reads or writes to the unit will generate a bus fault.</p>
2	GPIOC	R/W	0	<p>Port C Clock Gating Control</p> <p>This bit controls the clock gating for Port C. If set, the unit receives a clock and functions. Otherwise, the unit is unlocked and disabled. If the unit is unlocked, reads or writes to the unit will generate a bus fault.</p>
1	GPIOB	R/W	0	<p>Port B Clock Gating Control</p> <p>This bit controls the clock gating for Port B. If set, the unit receives a clock and functions. Otherwise, the unit is unlocked and disabled. If the unit is unlocked, reads or writes to the unit will generate a bus fault.</p>
0	GPIOA	R/W	0	<p>Port A Clock Gating Control</p> <p>This bit controls the clock gating for Port A. If set, the unit receives a clock and functions. Otherwise, the unit is unlocked and disabled. If the unit is unlocked, reads or writes to the unit will generate a bus fault.</p>

Register 25: Sleep Mode Clock Gating Control Register 2 (SCGC2), offset 0x118

This register controls the clock gating logic. Each bit controls a clock enable for a given interface, function, or unit. If set, the unit receives a clock and functions. Otherwise, the unit is unlocked and disabled (saving power). If the unit is unlocked, reads or writes to the unit will generate a bus fault. The reset state of these bits is 0 (unlocked) unless otherwise noted, so that all functional units are disabled. It is the responsibility of software to enable the ports necessary for the application. Note that these registers may contain more bits than there are interfaces, functions, or units to control. This is to assure reasonable code compatibility with other family and future parts. **RCGC2** is the clock configuration register for running operation, **SCGC2** for Sleep operation, and **DCGC2** for Deep-Sleep operation. Setting the **ACG** bit in the **Run-Mode Clock Configuration (RCC)** register specifies that the system uses sleep modes.

Sleep Mode Clock Gating Control Register 2 (SCGC2)

Base 0x400F.E000
 Offset 0x118
 Type R/W, reset 0x00000000

	31	30	29	28	27	26	25	24	23	22	21	20	19	18	17	16	
	reserved	EPHY0	reserved	EMAC0	reserved												
Type	RO	R/W	RO	R/W	RO	RO	RO	RO	RO	RO	RO	RO	RO	RO	RO	RO	
Reset	0	0	0	0	0	0	0	0	0	0	0	0	0	0	0	0	
	15	14	13	12	11	10	9	8	7	6	5	4	3	2	1	0	
	reserved										GPIOG	GPIOF	GPIOE	GPIOD	GPIOC	GPIOB	GPIOA
Type	RO	RO	RO	RO	RO	RO	RO	RO	RO	RO	R/W	R/W	R/W	R/W	R/W	R/W	
Reset	0	0	0	0	0	0	0	0	0	0	0	0	0	0	0	0	

Bit/Field	Name	Type	Reset	Description
31	reserved	RO	0	Software should not rely on the value of a reserved bit. To provide compatibility with future products, the value of a reserved bit should be preserved across a read-modify-write operation.
30	EPHY0	R/W	0	PHY0 Clock Gating Control This bit controls the clock gating for Ethernet PHY unit 0. If set, the unit receives a clock and functions. Otherwise, the unit is unlocked and disabled. If the unit is unlocked, reads or writes to the unit will generate a bus fault.
29	reserved	RO	0	Software should not rely on the value of a reserved bit. To provide compatibility with future products, the value of a reserved bit should be preserved across a read-modify-write operation.
28	EMAC0	R/W	0	MAC0 Clock Gating Control This bit controls the clock gating for Ethernet MAC unit 0. If set, the unit receives a clock and functions. Otherwise, the unit is unlocked and disabled. If the unit is unlocked, reads or writes to the unit will generate a bus fault.
27:7	reserved	RO	0	Software should not rely on the value of a reserved bit. To provide compatibility with future products, the value of a reserved bit should be preserved across a read-modify-write operation.

Bit/Field	Name	Type	Reset	Description
6	GPIOG	R/W	0	<p>Port G Clock Gating Control</p> <p>This bit controls the clock gating for Port G. If set, the unit receives a clock and functions. Otherwise, the unit is unlocked and disabled. If the unit is unlocked, reads or writes to the unit will generate a bus fault.</p>
5	GPIOF	R/W	0	<p>Port F Clock Gating Control</p> <p>This bit controls the clock gating for Port F. If set, the unit receives a clock and functions. Otherwise, the unit is unlocked and disabled. If the unit is unlocked, reads or writes to the unit will generate a bus fault.</p>
4	GPIOE	R/W	0	<p>Port E Clock Gating Control</p> <p>This bit controls the clock gating for Port E. If set, the unit receives a clock and functions. Otherwise, the unit is unlocked and disabled. If the unit is unlocked, reads or writes to the unit will generate a bus fault.</p>
3	GPIOD	R/W	0	<p>Port D Clock Gating Control</p> <p>This bit controls the clock gating for Port D. If set, the unit receives a clock and functions. Otherwise, the unit is unlocked and disabled. If the unit is unlocked, reads or writes to the unit will generate a bus fault.</p>
2	GPIOC	R/W	0	<p>Port C Clock Gating Control</p> <p>This bit controls the clock gating for Port C. If set, the unit receives a clock and functions. Otherwise, the unit is unlocked and disabled. If the unit is unlocked, reads or writes to the unit will generate a bus fault.</p>
1	GPIOB	R/W	0	<p>Port B Clock Gating Control</p> <p>This bit controls the clock gating for Port B. If set, the unit receives a clock and functions. Otherwise, the unit is unlocked and disabled. If the unit is unlocked, reads or writes to the unit will generate a bus fault.</p>
0	GPIOA	R/W	0	<p>Port A Clock Gating Control</p> <p>This bit controls the clock gating for Port A. If set, the unit receives a clock and functions. Otherwise, the unit is unlocked and disabled. If the unit is unlocked, reads or writes to the unit will generate a bus fault.</p>

Register 26: Deep Sleep Mode Clock Gating Control Register 2 (DCGC2), offset 0x128

This register controls the clock gating logic. Each bit controls a clock enable for a given interface, function, or unit. If set, the unit receives a clock and functions. Otherwise, the unit is unlocked and disabled (saving power). If the unit is unlocked, reads or writes to the unit will generate a bus fault. The reset state of these bits is 0 (unlocked) unless otherwise noted, so that all functional units are disabled. It is the responsibility of software to enable the ports necessary for the application. Note that these registers may contain more bits than there are interfaces, functions, or units to control. This is to assure reasonable code compatibility with other family and future parts. **RCGC2** is the clock configuration register for running operation, **SCGC2** for Sleep operation, and **DCGC2** for Deep-Sleep operation. Setting the **ACG** bit in the **Run-Mode Clock Configuration (RCC)** register specifies that the system uses sleep modes.

Deep Sleep Mode Clock Gating Control Register 2 (DCGC2)

Base 0x400F.E000

Offset 0x128

Type R/W, reset 0x00000000

	31	30	29	28	27	26	25	24	23	22	21	20	19	18	17	16	
	reserved	EPHY0	reserved	EMAC0	reserved												
Type	RO	R/W	RO	R/W	RO	RO	RO	RO	RO	RO	RO	RO	RO	RO	RO	RO	
Reset	0	0	0	0	0	0	0	0	0	0	0	0	0	0	0	0	
	15	14	13	12	11	10	9	8	7	6	5	4	3	2	1	0	
	reserved										GPIOG	GPIOF	GPIOE	GPIOD	GPIOC	GPIOB	GPIOA
Type	RO	RO	RO	RO	RO	RO	RO	RO	RO	RO	R/W	R/W	R/W	R/W	R/W	R/W	
Reset	0	0	0	0	0	0	0	0	0	0	0	0	0	0	0	0	

Bit/Field	Name	Type	Reset	Description
31	reserved	RO	0	Software should not rely on the value of a reserved bit. To provide compatibility with future products, the value of a reserved bit should be preserved across a read-modify-write operation.
30	EPHY0	R/W	0	PHY0 Clock Gating Control This bit controls the clock gating for Ethernet PHY unit 0. If set, the unit receives a clock and functions. Otherwise, the unit is unlocked and disabled. If the unit is unlocked, reads or writes to the unit will generate a bus fault.
29	reserved	RO	0	Software should not rely on the value of a reserved bit. To provide compatibility with future products, the value of a reserved bit should be preserved across a read-modify-write operation.
28	EMAC0	R/W	0	MAC0 Clock Gating Control This bit controls the clock gating for Ethernet MAC unit 0. If set, the unit receives a clock and functions. Otherwise, the unit is unlocked and disabled. If the unit is unlocked, reads or writes to the unit will generate a bus fault.
27:7	reserved	RO	0	Software should not rely on the value of a reserved bit. To provide compatibility with future products, the value of a reserved bit should be preserved across a read-modify-write operation.

Bit/Field	Name	Type	Reset	Description
6	GPIOG	R/W	0	<p>Port G Clock Gating Control</p> <p>This bit controls the clock gating for Port G. If set, the unit receives a clock and functions. Otherwise, the unit is unlocked and disabled. If the unit is unlocked, reads or writes to the unit will generate a bus fault.</p>
5	GPIOF	R/W	0	<p>Port F Clock Gating Control</p> <p>This bit controls the clock gating for Port F. If set, the unit receives a clock and functions. Otherwise, the unit is unlocked and disabled. If the unit is unlocked, reads or writes to the unit will generate a bus fault.</p>
4	GPIOE	R/W	0	<p>Port E Clock Gating Control</p> <p>This bit controls the clock gating for Port E. If set, the unit receives a clock and functions. Otherwise, the unit is unlocked and disabled. If the unit is unlocked, reads or writes to the unit will generate a bus fault.</p>
3	GPIOD	R/W	0	<p>Port D Clock Gating Control</p> <p>This bit controls the clock gating for Port D. If set, the unit receives a clock and functions. Otherwise, the unit is unlocked and disabled. If the unit is unlocked, reads or writes to the unit will generate a bus fault.</p>
2	GPIOC	R/W	0	<p>Port C Clock Gating Control</p> <p>This bit controls the clock gating for Port C. If set, the unit receives a clock and functions. Otherwise, the unit is unlocked and disabled. If the unit is unlocked, reads or writes to the unit will generate a bus fault.</p>
1	GPIOB	R/W	0	<p>Port B Clock Gating Control</p> <p>This bit controls the clock gating for Port B. If set, the unit receives a clock and functions. Otherwise, the unit is unlocked and disabled. If the unit is unlocked, reads or writes to the unit will generate a bus fault.</p>
0	GPIOA	R/W	0	<p>Port A Clock Gating Control</p> <p>This bit controls the clock gating for Port A. If set, the unit receives a clock and functions. Otherwise, the unit is unlocked and disabled. If the unit is unlocked, reads or writes to the unit will generate a bus fault.</p>

Register 27: Software Reset Control 0 (SRCR0), offset 0x040

Writes to this register are masked by the bits in the **Device Capabilities 1 (DC1)** register.

Software Reset Control 0 (SRCR0)

Base 0x400F.E000
 Offset 0x040
 Type R/W, reset 0x00000000

	31	30	29	28	27	26	25	24	23	22	21	20	19	18	17	16
	reserved											PWM	reserved			ADC
Type	RO	RO	RO	RO	RO	RO	RO	RO	RO	RO	RO	R/W	RO	RO	RO	R/W
Reset	0	0	0	0	0	0	0	0	0	0	0	0	0	0	0	0
	15	14	13	12	11	10	9	8	7	6	5	4	3	2	1	0
	reserved									HIB	reserved		WDT	reserved		
Type	RO	RO	RO	RO	RO	RO	RO	RO	RO	R/W	RO	RO	R/W	RO	RO	RO
Reset	0	0	0	0	0	0	0	0	0	0	0	0	0	0	0	0

Bit/Field	Name	Type	Reset	Description
31:21	reserved	RO	0	Software should not rely on the value of a reserved bit. To provide compatibility with future products, the value of a reserved bit should be preserved across a read-modify-write operation.
20	PWM	R/W	0	PWM Reset Control Reset control for PWM module.
19:17	reserved	RO	0	Software should not rely on the value of a reserved bit. To provide compatibility with future products, the value of a reserved bit should be preserved across a read-modify-write operation.
16	ADC	R/W	0	ADC0 Reset Control Reset control for SAR ADC module 0.
15:7	reserved	RO	0	Software should not rely on the value of a reserved bit. To provide compatibility with future products, the value of a reserved bit should be preserved across a read-modify-write operation.
6	HIB	R/W	0	HIB Reset Control Reset control for the Hibernation module.
5:4	reserved	RO	0	Software should not rely on the value of a reserved bit. To provide compatibility with future products, the value of a reserved bit should be preserved across a read-modify-write operation.
3	WDT	R/W	0	WDT Reset Control Reset control for Watchdog unit.
2:0	reserved	RO	0	Software should not rely on the value of a reserved bit. To provide compatibility with future products, the value of a reserved bit should be preserved across a read-modify-write operation.

Register 28: Software Reset Control 1 (SRCR1), offset 0x044Writes to this register are masked by the bits in the **Device Capabilities 2 (DC2)** register.

Software Reset Control 1 (SRCR1)

Base 0x400F.E000

Offset 0x044

Type R/W, reset 0x00000000

	31	30	29	28	27	26	25	24	23	22	21	20	19	18	17	16
	reserved												TIMER3	TIMER2	TIMER1	TIMER0
Type	RO	RO	RO	RO	RO	RO	RO	RO	RO	RO	RO	RO	R/W	R/W	R/W	R/W
Reset	0	0	0	0	0	0	0	0	0	0	0	0	0	0	0	0
	15	14	13	12	11	10	9	8	7	6	5	4	3	2	1	0
	reserved			I2C0	reserved							SSI0	reserved	UART2	UART1	UART0
Type	RO	RO	RO	R/W	RO	RO	RO	RO	RO	RO	RO	R/W	RO	R/W	R/W	R/W
Reset	0	0	0	0	0	0	0	0	0	0	0	0	0	0	0	0

Bit/Field	Name	Type	Reset	Description
31:20	reserved	RO	0	Software should not rely on the value of a reserved bit. To provide compatibility with future products, the value of a reserved bit should be preserved across a read-modify-write operation.
19	TIMER3	R/W	0	Timer 3 Reset Control Reset control for General-Purpose Timer module 3.
18	TIMER2	R/W	0	Timer 2 Reset Control Reset control for General-Purpose Timer module 2.
17	TIMER1	R/W	0	Timer 1 Reset Control Reset control for General-Purpose Timer module 1.
16	TIMER0	R/W	0	Timer 0 Reset Control Reset control for General-Purpose Timer module 0.
15:13	reserved	RO	0	Software should not rely on the value of a reserved bit. To provide compatibility with future products, the value of a reserved bit should be preserved across a read-modify-write operation.
12	I2C0	R/W	0	I2C0 Reset Control Reset control for I2C unit 0.
11:5	reserved	RO	0	Software should not rely on the value of a reserved bit. To provide compatibility with future products, the value of a reserved bit should be preserved across a read-modify-write operation.
4	SSI0	R/W	0	SSI0 Reset Control Reset control for SSI unit 0.
3	reserved	RO	0	Software should not rely on the value of a reserved bit. To provide compatibility with future products, the value of a reserved bit should be preserved across a read-modify-write operation.
2	UART2	R/W	0	UART2 Reset Control Reset control for UART unit 2.

Bit/Field	Name	Type	Reset	Description
1	UART1	R/W	0	UART1 Reset Control Reset control for UART unit 1.
0	UART0	R/W	0	UART0 Reset Control Reset control for UART unit 0.

Register 29: Software Reset Control 2 (SRCR2), offset 0x048Writes to this register are masked by the bits in the **Device Capabilities 4 (DC4)** register.

Software Reset Control 2 (SRCR2)

Base 0x400F.E000

Offset 0x048

Type R/W, reset 0x00000000

	31	30	29	28	27	26	25	24	23	22	21	20	19	18	17	16	
	reserved	EPHY0	reserved	EMAC0	reserved												
Type	RO	R/W	RO	R/W	RO	RO	RO	RO	RO	RO	RO	RO	RO	RO	RO	RO	
Reset	0	0	0	0	0	0	0	0	0	0	0	0	0	0	0	0	
	15	14	13	12	11	10	9	8	7	6	5	4	3	2	1	0	
	reserved										GPIOG	GPIOF	GPIOE	GPIOD	GPIOC	GPIOB	GPIOA
Type	RO	RO	RO	RO	RO	RO	RO	RO	RO	R/W	R/W	R/W	R/W	R/W	R/W	R/W	
Reset	0	0	0	0	0	0	0	0	0	0	0	0	0	0	0	0	

Bit/Field	Name	Type	Reset	Description
31	reserved	RO	0	Software should not rely on the value of a reserved bit. To provide compatibility with future products, the value of a reserved bit should be preserved across a read-modify-write operation.
30	EPHY0	R/W	0	PHY0 Reset Control Reset control for Ethernet PHY unit 0.
29	reserved	RO	0	Software should not rely on the value of a reserved bit. To provide compatibility with future products, the value of a reserved bit should be preserved across a read-modify-write operation.
28	EMAC0	R/W	0	MAC0 Reset Control Reset control for Ethernet MAC unit 0.
27:7	reserved	RO	0	Software should not rely on the value of a reserved bit. To provide compatibility with future products, the value of a reserved bit should be preserved across a read-modify-write operation.
6	GPIOG	R/W	0	Port G Reset Control Reset control for GPIO Port G.
5	GPIOF	R/W	0	Port F Reset Control Reset control for GPIO Port F.
4	GPIOE	R/W	0	Port E Reset Control Reset control for GPIO Port E.
3	GPIOD	R/W	0	Port D Reset Control Reset control for GPIO Port D.
2	GPIOC	R/W	0	Port C Reset Control Reset control for GPIO Port C.
1	GPIOB	R/W	0	Port B Reset Control Reset control for GPIO Port B.

Bit/Field	Name	Type	Reset	Description
0	GPIOA	R/W	0	Port A Reset Control Reset control for GPIO Port A.

7 Hibernation Module

The Hibernation Module manages removal and restoration of power to the rest of the microcontroller to provide a means for reducing power consumption. When the processor and peripherals are idle, power can be completely removed with only the Hibernation Module remaining powered. Power can be restored based on an external signal, or at a certain time using the built-in real-time clock (RTC). The Hibernation module can be independently supplied from a battery or an auxiliary power supply.

The Hibernation module has the following features:

- Power-switching logic to discrete external regulator
- Dedicated pin for waking from an external signal
- Low-battery detection, signaling, and interrupt generation
- 32-bit real-time counter (RTC)
- Two 32-bit RTC match registers for timed wake-up and interrupt generation
- Clock source from a 32.768-kHz external oscillator or a 4.194304-MHz crystal
- RTC predivider trim for making fine adjustments to the clock rate
- 64 32-bit words of non-volatile memory
- Programmable interrupts for RTC match, external wake, and low battery events

7.1 Block Diagram

Figure 7-1. Hibernation Module Block Diagram

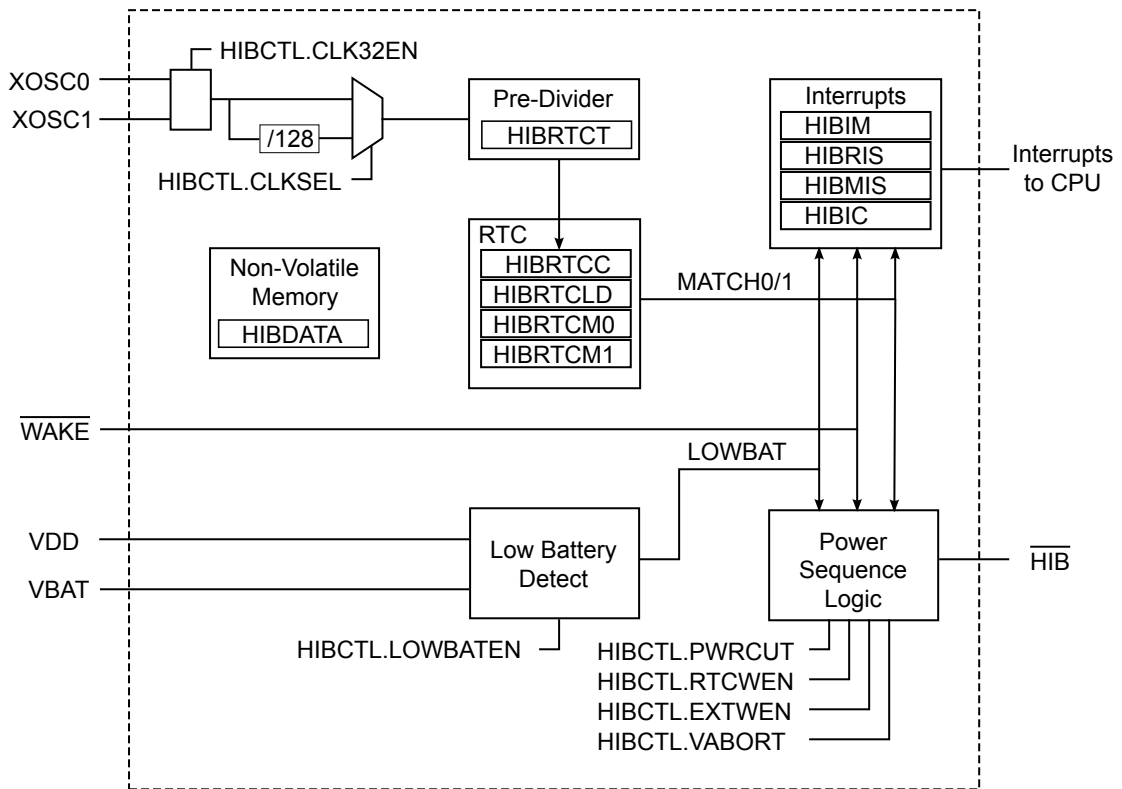

7.2 Functional Description

The Hibernation module controls the power to the processor with an enable signal (\overline{HIB}) that signals an external voltage regulator to turn off. The Hibernation module power is determined dynamically. The supply voltage of the Hibernation module is the larger of the main voltage source (VDD) or the battery/auxilliary voltage source (VBAT). A voting circuit indicates the larger and an internal power switch selects the appropriate voltage source. The Hibernation module also has a separate clock source to maintain a real-time clock (RTC). Once in hibernation, the module signals an external voltage regulator to turn back on the power when an external pin (\overline{WAKE}) is asserted, or when the internal RTC reaches a certain value. The Hibernation module can also detect when the battery voltage is low, and optionally prevent hibernation when this occurs.

Power-up from a power cut to code execution is defined as the regulator turn-on time (specified at $t_{HIB_TO_VDD}$ maximum) plus the normal chip POR (see "Hibernation Module" on page 503).

7.2.1 Register Access Timing

Because the Hibernation module has an independent clocking domain, certain registers must be written only with a timing gap between accesses. The delay time is $t_{HIB_REG_WRITE}$, therefore software must guarantee that a delay of $t_{HIB_REG_WRITE}$ is inserted between back-to-back writes to certain Hibernation registers, or between a write followed by a read to those same registers. There is no

restriction on timing for back-to-back reads from the Hibernation module. Refer to “Register Descriptions” on page 119 for details about which registers are subject to this timing restriction.

7.2.2 Clock Source

The Hibernation module must be clocked by an external source, even if the RTC feature will not be used. An external oscillator or crystal can be used for this purpose. To use a crystal, a 4.194304-MHz crystal is connected to the XOSC0 and XOSC1 pins. This clock signal is divided by 128 internally to produce the 32.768-kHz clock reference. To use a more precise clock source, a 32.768-kHz oscillator can be connected to the XOSC0 pin.

The clock source is enabled by setting the CLK32EN bit of the HIBCTL register. The type of clock source is selected by setting the CLKSEL bit to 0 for a 4.194304-MHz clock source, and to 1 for a 32.768-kHz clock source. If the bit is set to 0, the input clock is divided by 128, resulting in a 32.768-kHz clock source. If a crystal is used for the clock source, the software must leave a delay of t_{XOSC_SETTLE} after setting the CLK32EN bit and before any other accesses to the Hibernation module registers. The delay allows the crystal to power up and stabilize. If an oscillator is used for the clock source, no delay is needed.

7.2.3 Battery Management

The Hibernation module can be independently powered by a battery or an auxiliary power source. The module can monitor the voltage level of the battery and detect when the voltage becomes too low. When this happens, an interrupt can be generated. The module can also be configured so that it will not go into Hibernate mode if the battery voltage is too low.

Note that the Hibernation module draws power from whichever source (VBAT or VDD) has the higher voltage. Therefore, it is important to design the circuit to ensure that VDD is higher than VBAT under nominal conditions or else the Hibernation module draws power from the battery even when VDD is available.

The Hibernation module can be configured to detect a low battery condition by setting the LOWBATEN bit of the HIBCTL register. In this configuration, the LOWBAT bit of the HIBRIS register will be set when the battery level is low. If the VABORT bit is also set, then the module is prevented from entering Hibernation mode when a low battery is detected. The module can also be configured to generate an interrupt for the low-battery condition (see “Interrupts and Status” on page 116).

7.2.4 Real-Time Clock

The Hibernation module includes a 32-bit counter that increments once per second with a proper clock source and configuration (see “Clock Source” on page 115). The 32.768-kHz clock signal is fed into a predivider register which counts down the 32.768-kHz clock ticks to achieve a once per second clock rate for the RTC. The rate can be adjusted to compensate for inaccuracies in the clock source by using the predivider trim register. This register has a nominal value of 0x7FFF, and is used for one second out of every 64 seconds to divide the input clock. This allows the software to make fine corrections to the clock rate by adjusting the predivider trim register up or down from 0x7FFF. The predivider trim should be adjusted up from 0x7FFF in order to slow down the RTC rate, and down from 0x7FFF in order to speed up the RTC rate.

The Hibernation module includes two 32-bit match registers that are compared to the value of the RTC counter. The match registers can be used to wake the processor from hibernation mode, or to generate an interrupt to the processor if it is not in hibernation.

The RTC must be enabled with the RTCEN bit of the HIBCTL register. The value of the RTC can be set at any time by writing to the HIBRTCLD register. The predivider trim can be adjusted by reading and writing the HIBRTCT register. The predivider uses this register once every 64 seconds to adjust

the clock rate. The two match registers can be set by writing to the **HIBRTCM0** and **HIBRTCM1** registers. The RTC can be configured to generate interrupts by using the interrupt registers (see “Interrupts and Status” on page 116).

7.2.5 Non-Volatile Memory

The Hibernation module contains 64 32-bit words of memory which are retained during hibernation. This memory is powered from the battery or auxiliary power supply during hibernation. The processor software can save state information in this memory prior to hibernation, and can then recover the state upon waking. The non-volatile memory can be accessed through the **HIBDATA** registers.

7.2.6 Power Control

The Hibernation module controls power to the processor through the use of the $\overline{\text{HIB}}$ pin, which is intended to be connected to the enable signal of the external regulator(s) providing 3.3 V and/or 2.5 V to the microcontroller. When the $\overline{\text{HIB}}$ signal is asserted by the Hibernation module, the external regulator is turned off and no longer powers the microcontroller. The Hibernation module remains powered from the VBAT supply, which could be a battery or an auxiliary power source. Hibernation mode is initiated by the microcontroller setting the **HIBREQ** bit of the **HIBCTL** register. Prior to doing this, a wake-up condition must be configured, either from the external $\overline{\text{WAKE}}$ pin, or by using an RTC match.

The Hibernation module is configured to wake from the external $\overline{\text{WAKE}}$ pin by setting the **PINWEN** bit of the **HIBCTL** register. It is configured to wake from RTC match by setting the **RTCWEN** bit. Either one or both of these bits can be set prior to going into hibernation. The $\overline{\text{WAKE}}$ pin includes a weak internal pull-up. Note that both the $\overline{\text{HIB}}$ and $\overline{\text{WAKE}}$ pins use the Hibernation module's internal power supply as the logic 1 reference.

When the Hibernation module wakes, the microcontroller will see a normal power-on reset. It can detect that the power-on was due to a wake from hibernation by examining the raw interrupt status register (see “Interrupts and Status” on page 116) and by looking for state data in the non-volatile memory (see “Non-Volatile Memory” on page 116).

When the $\overline{\text{HIB}}$ signal deasserts, enabling the external regulator, the external regulator must reach the operating voltage within $t_{\text{HIB_TO_VDD}}$.

7.2.7 Interrupts and Status

The Hibernation module can generate interrupts when the following conditions occur:

- Assertion of $\overline{\text{WAKE}}$ pin
- RTC match
- Low battery detected

All of the interrupts are ORed together before being sent to the interrupt controller, so the Hibernation module can only generate a single interrupt request to the controller at any given time. The software interrupt handler can service multiple interrupt events by reading the **HIBMIS** register. Software can also read the status of the Hibernation module at any time by reading the **HIBRIS** register which shows all of the pending events. This register can be used at power-on to see if a wake condition is pending, which indicates to the software that a hibernation wake occurred.

The events that can trigger an interrupt are configured by setting the appropriate bits in the **HIBIM** register. Pending interrupts can be cleared by writing the corresponding bit in the **HIBIC** register.

7.3 Initialization and Configuration

The Hibernation module can be configured in several different combinations. The following sections show the recommended programming sequence for various scenarios. The examples below assume that a 32.768-kHz oscillator is used, and thus always show bit 2 (`CLKSEL`) of the **HIBCTL** register set to 1. If a 4.194304-MHz crystal is used instead, then the `CLKSEL` bit remains cleared. Because the Hibernation module runs at 32 kHz and is asynchronous to the rest of the system, software must allow a delay of $t_{\text{HIB_REG_WRITE}}$ after writes to certain registers (see “Register Access Timing” on page 114). The registers that require a delay are denoted with a footnote in Table 7-1 on page 118.

7.3.1 Initialization

The clock source must be enabled first, even if the RTC will not be used. If a 4.194304-MHz crystal is used, perform the following steps:

1. Write 0x40 to the **HIBCTL** register at offset 0x10 to enable the crystal and select the divide-by-128 input path.
2. Wait for a time of $t_{\text{XOSC_SETTLE}}$ for the crystal to power up and stabilize before performing any other operations with the Hibernation module.

If a 32.678-kHz oscillator is used, then perform the following steps:

1. Write 0x44 to the **HIBCTL** register at offset 0x10 to enable the oscillator input.
2. No delay is necessary.

The above is only necessary when the entire system is initialized for the first time. If the processor is powered due to a wake from hibernation, then the Hibernation module has already been powered up and the above steps are not necessary. The software can detect that the Hibernation module and clock are already powered by examining the `CLK32EN` bit of the **HIBCTL** register.

7.3.2 RTC Match Functionality (No Hibernation)

The following steps are needed to use the RTC match functionality of the Hibernation module:

1. Write the required RTC match value to one of the **HIBRTCMn** registers at offset 0x004 or 0x008.
2. Write the required RTC load value to the **HIBRTCLD** register at offset 0x00C.
3. Set the required RTC match interrupt mask in the `RTCALT0` and `RTCALT1` bits (bits 1:0) in the **HIBIM** register at offset 0x014.
4. Write 0x0000.0041 to the **HIBCTL** register at offset 0x010 to enable the RTC to begin counting.

7.3.3 RTC Match/Wake-Up from Hibernation

The following steps are needed to use the RTC match and wake-up functionality of the Hibernation module:

1. Write the required RTC match value to the **HIBRTCMn** registers at offset 0x004 or 0x008.
2. Write the required RTC load value to the **HIBRTCLD** register at offset 0x00C.
3. Write any data to be retained during power cut to the **HIBDATA** register at offsets 0x030-0x12C.

4. Set the RTC Match Wake-Up and start the hibernation sequence by writing 0x0000.004F to the **HIBCTL** register at offset 0x010.

7.3.4 External Wake-Up from Hibernation

The following steps are needed to use the Hibernation module with the external $\overline{\text{WAKE}}$ pin as the wake-up source for the microcontroller:

1. Write any data to be retained during power cut to the **HIBDATA** register at offsets 0x030-0x12C.
2. Enable the external wake and start the hibernation sequence by writing 0x0000.0056 to the **HIBCTL** register at offset 0x010.

7.3.5 RTC/External Wake-Up from Hibernation

1. Write the required RTC match value to the **HIBRTCMn** registers at offset 0x004 or 0x008.
2. Write the required RTC load value to the **HIBRTCLD** register at offset 0x00C.
3. Write any data to be retained during power cut to the **HIBDATA** register at offsets 0x030-0x12C.
4. Set the RTC Match/External Wake-Up and start the hibernation sequence by writing 0x0000.005F to the **HIBCTL** register at offset 0x010.

7.4 Register Map

Table 7-1 on page 118 lists the Hibernation registers. All addresses given are relative to the Hibernation Module base address at 0x400F.C000.

Note: **HIBRTCC**, **HIBRTCM0**, **HIBRTCM1**, **HIBRTCLD**, **HIBRTCT**, and **HIBDATA** are on the Hibernation module clock domain and require a delay of $t_{\text{HIB_REG_WRITE}}$ between write accesses. See “Register Access Timing” on page 114.

Table 7-1. Hibernation Module Register Map

Offset	Name	Type	Reset	Description	See page
0x000	HIBRTCC	RO	0x0000.0000	Hibernation RTC Counter	120
0x004	HIBRTCM0	R/W	0xFFFF.FFFF	Hibernation RTC Match 0	121
0x008	HIBRTCM1	R/W	0xFFFF.FFFF	Hibernation RTC Match 1	122
0x00C	HIBRTCLD	R/W	0xFFFF.FFFF	Hibernation RTC Load	123
0x010	HIBCTL	R/W	0x0000.0000	Hibernation Control	124
0x014	HIBIM	R/W	0x0000.0000	Hibernation Interrupt Mask	126
0x018	HIBRIS	RO	0x0000.0000	Hibernation Raw Interrupt Status	127
0x01C	HIBMIS	RO	0x0000.0000	Hibernation Masked Interrupt Status	128
0x020	HIBIC	R/W1C	0x0000.0000	Hibernation Interrupt Clear	129
0x024	HIBRTCT	R/W	0x0000.7FFF	Hibernation RTC Trim	130
0x030-0x12C	HIBDATA	R/W	0x0000.0000	Hibernation Data	131

7.5 Register Descriptions

The remainder of this section lists and describes the Hibernation module registers, in numerical order by address offset.

Register 1: Hibernation RTC Counter (HIBRTCC), offset 0x000

This register is the current 32-bit value of the RTC counter.

Hibernation RTC Counter (HIBRTCC)

Base 0x400F.C000

Offset 0x000

Type RO, reset 0x0000.0000

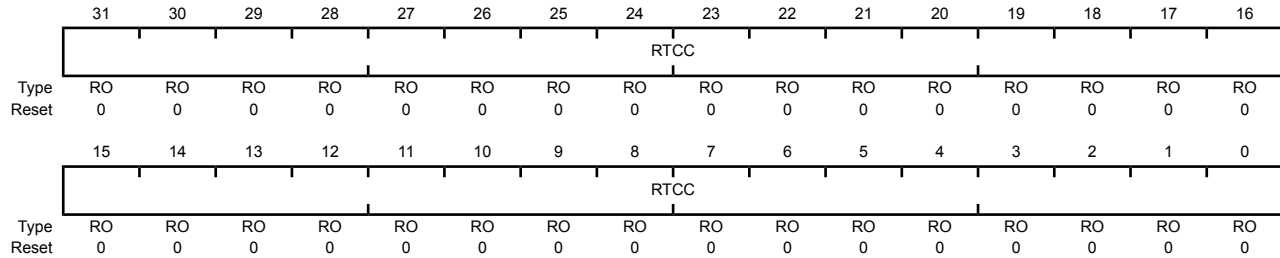

Bit/Field	Name	Type	Reset	Description
31:0	RTCC	RO	0x0000.0000	RTC Counter

A read returns the 32-bit counter value. This register is read-only. To change the value, use the **HIBRTCLD** register.

Register 2: Hibernation RTC Match 0 (HIBRTCM0), offset 0x004

This register is the 32-bit match 0 register for the RTC counter.

Hibernation RTC Match 0 (HIBRTCM0)

Base 0x400F.C000

Offset 0x004

Type R/W, reset 0xFFFF.FFFF

	31	30	29	28	27	26	25	24	23	22	21	20	19	18	17	16
	RTCM0															
Type	R/W	R/W	R/W	R/W	R/W	R/W	R/W	R/W	R/W	R/W	R/W	R/W	R/W	R/W	R/W	R/W
Reset	1	1	1	1	1	1	1	1	1	1	1	1	1	1	1	1
	15	14	13	12	11	10	9	8	7	6	5	4	3	2	1	0
	RTCM0															
Type	R/W	R/W	R/W	R/W	R/W	R/W	R/W	R/W	R/W	R/W	R/W	R/W	R/W	R/W	R/W	R/W
Reset	1	1	1	1	1	1	1	1	1	1	1	1	1	1	1	1

Bit/Field	Name	Type	Reset	Description
31:0	RTCM0	R/W	0xFFFF.FFFF	RTC Match 0

A write loads the value into the RTC match register.

A read returns the current match value.

Register 3: Hibernation RTC Match 1 (HIBRTCM1), offset 0x008

This register is the 32-bit match 1 register for the RTC counter.

Hibernation RTC Match 1 (HIBRTCM1)

Base 0x400F.C000

Offset 0x008

Type R/W, reset 0xFFFF.FFFF

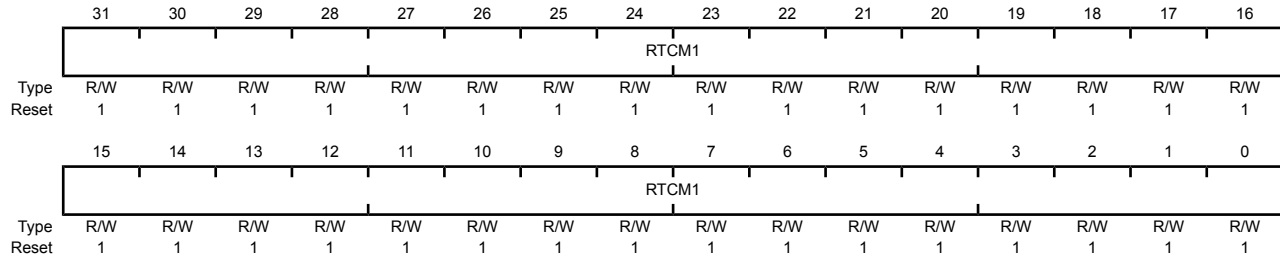

Bit/Field	Name	Type	Reset	Description
31:0	RTCM1	R/W	0xFFFF.FFFF	RTC Match 1

A write loads the value into the RTC match register.

A read returns the current match value.

Register 4: Hibernation RTC Load (HIBRTCLD), offset 0x00C

This register is the 32-bit value loaded into the RTC counter.

Hibernation RTC Load (HIBRTCLD)

Base 0x400F.C000

Offset 0x00C

Type R/W, reset 0xFFFF.FFFF

	31	30	29	28	27	26	25	24	23	22	21	20	19	18	17	16
	RTCLD															
Type	R/W	R/W	R/W	R/W	R/W	R/W	R/W	R/W	R/W	R/W	R/W	R/W	R/W	R/W	R/W	R/W
Reset	1	1	1	1	1	1	1	1	1	1	1	1	1	1	1	1
	15	14	13	12	11	10	9	8	7	6	5	4	3	2	1	0
	RTCLD															
Type	R/W	R/W	R/W	R/W	R/W	R/W	R/W	R/W	R/W	R/W	R/W	R/W	R/W	R/W	R/W	R/W
Reset	1	1	1	1	1	1	1	1	1	1	1	1	1	1	1	1

Bit/Field	Name	Type	Reset	Description
31:0	RTCLD	R/W	0xFFFF.FFFF	RTC Load

A write loads the current value into the RTC counter (RTCC).

A read returns the 32-bit load value.

Register 5: Hibernation Control (HIBCTL), offset 0x010

This register is the control register for the Hibernation module.

Hibernation Control (HIBCTL)

Base 0x400F.C000

Offset 0x010

Type R/W, reset 0x0000.0000

	31	30	29	28	27	26	25	24	23	22	21	20	19	18	17	16
	reserved															
Type	RO	RO	RO	RO	RO	RO	RO	RO	RO	RO	RO	RO	RO	RO	RO	RO
Reset	0	0	0	0	0	0	0	0	0	0	0	0	0	0	0	0
	15	14	13	12	11	10	9	8	7	6	5	4	3	2	1	0
	reserved								VABORT	CLK32EN	LOWBATEN	PINWEN	RTCWEN	CLKSEL	HIBREQ	RTCEN
Type	RO	RO	RO	RO	RO	RO	RO	RO	R/W	R/W	R/W	R/W	R/W	R/W	R/W	R/W
Reset	0	0	0	0	0	0	0	0	0	0	0	0	0	0	0	0

Bit/Field	Name	Type	Reset	Description
31:8	reserved	RO	0x00	Software should not rely on the value of a reserved bit. To provide compatibility with future products, the value of a reserved bit should be preserved across a read-modify-write operation.
7	VABORT	R/W	0	Power Cut Abort Enable 0: Power cut occurs during a low-battery alert 1: Power cut is aborted
6	CLK32EN	R/W	0	32-kHz Oscillator Enable 0: Disabled 1: Enabled This bit must be enabled to use the Hibernation module. If a crystal is used, then software should wait 20 ms after setting this bit to allow the crystal to power up and stabilize.
5	LOWBATEN	R/W	0	Low Battery Monitoring Enable 0: Disabled 1: Enabled When set, low battery voltage detection is enabled.
4	PINWEN	R/W	0	External $\overline{\text{WAKE}}$ Pin Enable 0: Disabled 1: Enabled When set, an external event on the $\overline{\text{WAKE}}$ pin will re-power the device.
3	RTCWEN	R/W	0	RTC Wake-up Enable 0: Disabled 1: Enabled When set, an RTC match event (RTC_0 or RTC_1) will re-power the device based on the RTC counter value matching the corresponding match register 0 or 1.

Bit/Field	Name	Type	Reset	Description
2	CLKSEL	R/W	0	Hibernation Module Clock Select 0: Use Divide by 128 output. Use this value for a 4-MHz crystal. 1: Use raw output. Use this value for a 32-kHz oscillator.
1	HIBREQ	R/W	0	Hibernation Request 0: Disabled 1: Hibernation initiated After a wake-up event, this bit is cleared by hardware.
0	RTCEN	R/W	0	RTC Timer Enable 0: Disabled 1: Enabled

Register 6: Hibernation Interrupt Mask (HIBIM), offset 0x014

This register is the interrupt mask register for the Hibernation module interrupt sources.

Hibernation Interrupt Mask (HIBIM)

Base 0x400F.C000

Offset 0x014

Type R/W, reset 0x0000.0000

	31	30	29	28	27	26	25	24	23	22	21	20	19	18	17	16
	reserved															
Type	RO	RO	RO	RO	RO	RO	RO	RO	RO	RO	RO	RO	RO	RO	RO	RO
Reset	0	0	0	0	0	0	0	0	0	0	0	0	0	0	0	0
	15	14	13	12	11	10	9	8	7	6	5	4	3	2	1	0
	reserved												EXTW	LOWBAT	RTCALT1	RTCALT0
Type	RO	RO	RO	RO	RO	RO	RO	RO	RO	RO	RO	RO	R/W	R/W	R/W	R/W
Reset	0	0	0	0	0	0	0	0	0	0	0	0	0	0	0	0

Bit/Field	Name	Type	Reset	Description
31:4	reserved	RO	0x000.0000	Software should not rely on the value of a reserved bit. To provide compatibility with future products, the value of a reserved bit should be preserved across a read-modify-write operation.
3	EXTW	R/W	0	External Wake-Up Interrupt Mask 0: Masked 1: Unmasked
2	LOWBAT	R/W	0	Low Battery Voltage Interrupt Mask 0: Masked 1: Unmasked
1	RTCALT1	R/W	0	RTC Alert1 Interrupt Mask 0: Masked 1: Unmasked
0	RTCALT0	R/W	0	RTC Alert0 Interrupt Mask 0: Masked 1: Unmasked

Register 7: Hibernation Raw Interrupt Status (HIBRIS), offset 0x018

This register is the raw interrupt status for the Hibernation module interrupt sources.

Hibernation Raw Interrupt Status (HIBRIS)

Base 0x400F.C000

Offset 0x018

Type RO, reset 0x0000.0000

	31	30	29	28	27	26	25	24	23	22	21	20	19	18	17	16	
	reserved																
Type	RO	RO	RO	RO	RO	RO	RO	RO	RO	RO	RO	RO	RO	RO	RO	RO	
Reset	0	0	0	0	0	0	0	0	0	0	0	0	0	0	0	0	
	15	14	13	12	11	10	9	8	7	6	5	4	3	2	1	0	
	reserved													EXTW	LOWBAT	RTCALT1	RTCALT0
Type	RO	RO	RO	RO	RO	RO	RO	RO	RO	RO	RO	RO	RO	RO	RO	RO	
Reset	0	0	0	0	0	0	0	0	0	0	0	0	0	0	0	0	

Bit/Field	Name	Type	Reset	Description
31:4	reserved	RO	0x000.0000	Software should not rely on the value of a reserved bit. To provide compatibility with future products, the value of a reserved bit should be preserved across a read-modify-write operation.
3	EXTW	RO	0	External Wake-Up Raw Interrupt Status
2	LOWBAT	RO	0	Low Battery Voltage Raw Interrupt Status
1	RTCALT1	RO	0	RTC Alert1 Raw Interrupt Status
0	RTCALT0	RO	0	RTC Alert0 Raw Interrupt Status

Register 8: Hibernation Masked Interrupt Status (HIBMIS), offset 0x01C

This register is the masked interrupt status for the Hibernation module interrupt sources.

Hibernation Masked Interrupt Status (HIBMIS)

Base 0x400F.C000

Offset 0x01C

Type RO, reset 0x0000.0000

	31	30	29	28	27	26	25	24	23	22	21	20	19	18	17	16	
	reserved																
Type	RO	RO	RO	RO	RO	RO	RO	RO	RO	RO	RO	RO	RO	RO	RO	RO	
Reset	0	0	0	0	0	0	0	0	0	0	0	0	0	0	0	0	
	15	14	13	12	11	10	9	8	7	6	5	4	3	2	1	0	
	reserved													EXTW	LOWBAT	RTCALT1	RTCALT0
Type	RO	RO	RO	RO	RO	RO	RO	RO	RO	RO	RO	RO	RO	RO	RO	RO	
Reset	0	0	0	0	0	0	0	0	0	0	0	0	0	0	0	0	

Bit/Field	Name	Type	Reset	Description
31:4	reserved	RO	0x000.0000	Software should not rely on the value of a reserved bit. To provide compatibility with future products, the value of a reserved bit should be preserved across a read-modify-write operation.
3	EXTW	RO	0	External Wake-Up Masked Interrupt Status
2	LOWBAT	RO	0	Low Battery Voltage Masked Interrupt Status
1	RTCALT1	RO	0	RTC Alert1 Masked Interrupt Status
0	RTCALT0	RO	0	RTC Alert0 Masked Interrupt Status

Register 9: Hibernation Interrupt Clear (HIBIC), offset 0x020

This register is the interrupt write-one-to-clear register for the Hibernation module interrupt sources.

Hibernation Interrupt Clear (HIBIC)

Base 0x400F.C000

Offset 0x020

Type R/W1C, reset 0x0000.0000

	31	30	29	28	27	26	25	24	23	22	21	20	19	18	17	16	
	reserved																
Type	RO	RO	RO	RO	RO	RO	RO	RO	RO	RO	RO	RO	RO	RO	RO	RO	
Reset	0	0	0	0	0	0	0	0	0	0	0	0	0	0	0	0	
	15	14	13	12	11	10	9	8	7	6	5	4	3	2	1	0	
	reserved												EXTW	LOWBAT	RTCALT1	RTCALT0	
Type	RO	RO	RO	RO	RO	RO	RO	RO	RO	RO	RO	RO	RO	R/W1C	R/W1C	R/W1C	R/W1C
Reset	0	0	0	0	0	0	0	0	0	0	0	0	0	0	0	0	0

Bit/Field	Name	Type	Reset	Description
31:4	reserved	RO	0x000.0000	Software should not rely on the value of a reserved bit. To provide compatibility with future products, the value of a reserved bit should be preserved across a read-modify-write operation.
3	EXTW	R/W1C	0	External Wake-Up Masked Interrupt Clear Reads return an indeterminate value.
2	LOWBAT	R/W1C	0	Low Battery Voltage Masked Interrupt Clear Reads return an indeterminate value.
1	RTCALT1	R/W1C	0	RTC Alert1 Masked Interrupt Clear Reads return an indeterminate value.
0	RTCALT0	R/W1C	0	RTC Alert0 Masked Interrupt Clear Reads return an indeterminate value.

Register 10: Hibernation RTC Trim (HIBRTCT), offset 0x024

This register contains the value that is used to trim the RTC clock predivider. It represents the computed underflow value that is used during the trim cycle. It is represented as $0x7FFF \pm N$ clock cycles.

Hibernation RTC Trim (HIBRTCT)

Base 0x400F.C000

Offset 0x024

Type R/W, reset 0x0000.7FFF

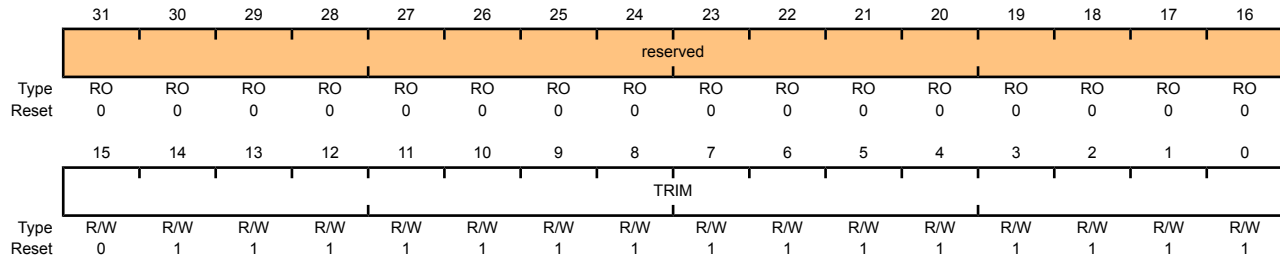

Bit/Field	Name	Type	Reset	Description
31:16	reserved	RO	0x0000	Software should not rely on the value of a reserved bit. To provide compatibility with future products, the value of a reserved bit should be preserved across a read-modify-write operation.
15:0	TRIM	R/W	0x7FFF	RTC Trim Value This value is loaded into the RTC predivider every 64 seconds. It is used to adjust the RTC rate to account for drift and inaccuracy in the clock source. The compensation is made by software by adjusting the default value of 0x7FFF up or down.

Register 11: Hibernation Data (HIBDATA), offset 0x030-0x12C

This address space is implemented as a 64x32-bit memory (256 bytes). It can be loaded by the system processor in order to store any non-volatile state data and will not lose power during a power cut operation.

Hibernation Data (HIBDATA)

Base 0x400F.C000

Offset 0x030-0x12C

Type R/W, reset 0x0000.0000

	31	30	29	28	27	26	25	24	23	22	21	20	19	18	17	16
	RTD															
Type	R/W	R/W	R/W	R/W	R/W	R/W	R/W	R/W	R/W	R/W	R/W	R/W	R/W	R/W	R/W	R/W
Reset	0	0	0	0	0	0	0	0	0	0	0	0	0	0	0	0
	15	14	13	12	11	10	9	8	7	6	5	4	3	2	1	0
	RTD															
Type	R/W	R/W	R/W	R/W	R/W	R/W	R/W	R/W	R/W	R/W	R/W	R/W	R/W	R/W	R/W	R/W
Reset	0	0	0	0	0	0	0	0	0	0	0	0	0	0	0	0

Bit/Field	Name	Type	Reset	Description
31:0	RTD	R/W	0x0000.0000	Hibernation Module NV Registers[63:0]

8 Internal Memory

The LM3S6916 microcontroller comes with 64 KB of bit-banded SRAM and 256 KB of flash memory. The flash controller provides a user-friendly interface, making flash programming a simple task. Flash protection can be applied to the flash memory on a 2-KB block basis.

8.1 Block Diagram

Figure 8-1. Flash Block Diagram

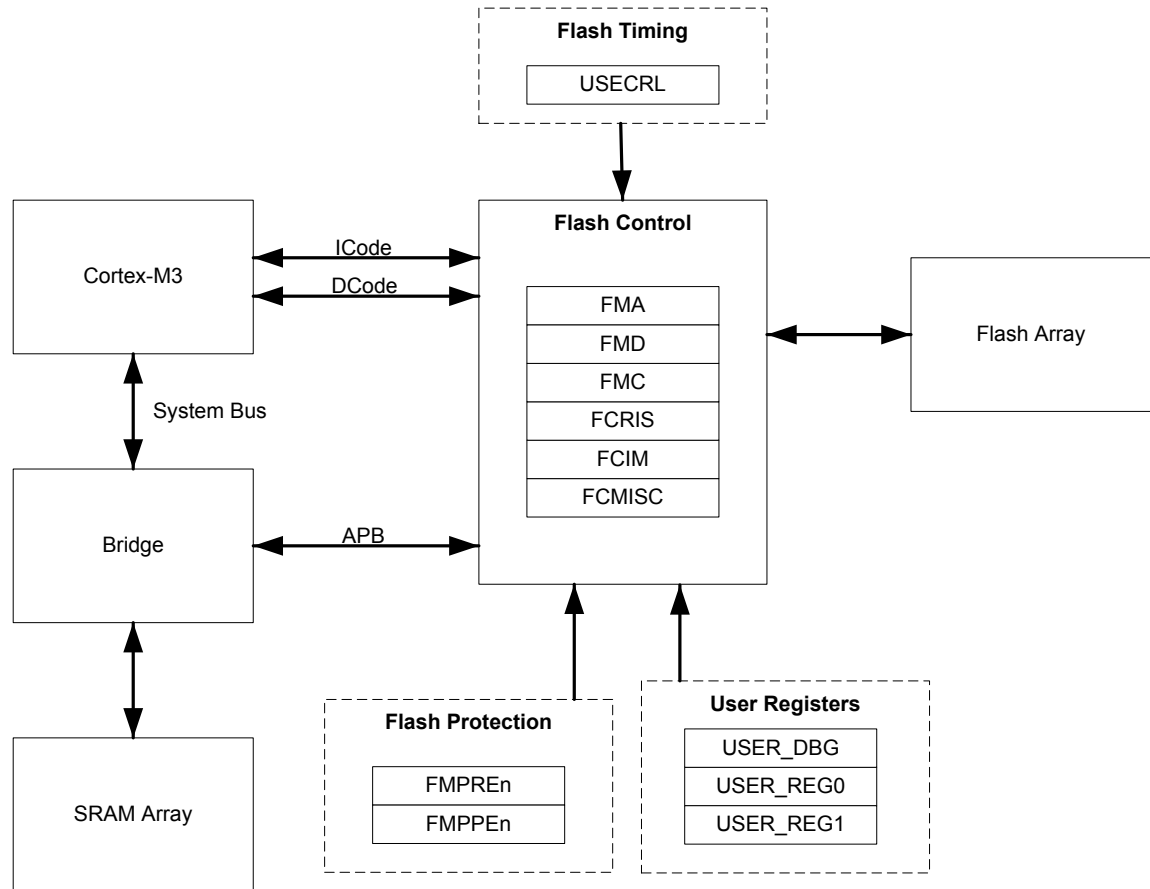

8.2 Functional Description

This section describes the functionality of both the flash and SRAM memories.

8.2.1 SRAM Memory

The internal SRAM of the Stellaris[®] devices is located at address 0x2000.0000 of the device memory map. To reduce the number of time consuming read-modify-write (RMW) operations, ARM has introduced *bit-banding* technology in the Cortex-M3 processor. With a bit-band-enabled processor, certain regions in the memory map (SRAM and peripheral space) can use address aliases to access individual bits in a single, atomic operation.

The bit-band alias is calculated by using the formula:

$\text{bit-band alias} = \text{bit-band base} + (\text{byte offset} * 32) + (\text{bit number} * 4)$

For example, if bit 3 at address 0x2000.1000 is to be modified, the bit-band alias is calculated as:

$0x2200.0000 + (0x1000 * 32) + (3 * 4) = 0x2202.000C$

With the alias address calculated, an instruction performing a read/write to address 0x2202.000C allows direct access to only bit 3 of the byte at address 0x2000.1000.

For details about bit-banding, please refer to Chapter 4, “Memory Map” in the *ARM® Cortex™-M3 Technical Reference Manual*.

8.2.2 Flash Memory

The flash is organized as a set of 1-KB blocks that can be individually erased. Erasing a block causes the entire contents of the block to be reset to all 1s. An individual 32-bit word can be programmed to change bits that are currently 1 to a 0. These blocks are paired into a set of 2-KB blocks that can be individually protected. The protection allows blocks to be marked as read-only or execute-only, providing different levels of code protection. Read-only blocks cannot be erased or programmed, protecting the contents of those blocks from being modified. Execute-only blocks cannot be erased or programmed, and can only be read by the controller instruction fetch mechanism, protecting the contents of those blocks from being read by either the controller or by a debugger.

See also “Serial Flash Loader” on page 512 for a preprogrammed flash-resident utility used to download code to the flash memory of a device without the use of a debug interface.

8.2.2.1 Flash Memory Timing

The timing for the flash is automatically handled by the flash controller. However, in order to do so, it must know the clock rate of the system in order to time its internal signals properly. The number of clock cycles per microsecond must be provided to the flash controller for it to accomplish this timing. It is software's responsibility to keep the flash controller updated with this information via the **Usec Reload (USECRL)** register.

On reset, the **USECRL** register is loaded with a value that configures the flash timing so that it works with the maximum clock rate of the part. If software changes the system operating frequency, the new operating frequency minus 1 (in MHz) must be loaded into **USECRL** before any flash modifications are attempted. For example, if the device is operating at a speed of 20 MHz, a value of 0x13 (20-1) must be written to the **USECRL** register.

8.2.2.2 Flash Memory Protection

The user is provided two forms of flash protection per 2-KB flash blocks in four pairs of 32-bit wide registers. The protection policy for each form is controlled by individual bits (per policy per block) in the **FMPPEn** and **FMPREn** registers.

- **Flash Memory Protection Program Enable (FMPPEn)**: If set, the block may be programmed (written) or erased. If cleared, the block may not be changed.
- **Flash Memory Protection Read Enable (FMPREn)**: If set, the block may be executed or read by software or debuggers. If cleared, the block may only be executed. The contents of the memory block are prohibited from being accessed as data and traversing the DCode bus.

The policies may be combined as shown in Table 8-1 on page 134.

Table 8-1. Flash Protection Policy Combinations

FMPPEn	FMPREn	Protection
0	0	Execute-only protection. The block may only be executed and may not be written or erased. This mode is used to protect code.
1	0	The block may be written, erased or executed, but not read. This combination is unlikely to be used.
0	1	Read-only protection. The block may be read or executed but may not be written or erased. This mode is used to lock the block from further modification while allowing any read or execute access.
1	1	No protection. The block may be written, erased, executed or read.

An access that attempts to program or erase a PE-protected block is prohibited. A controller interrupt may be optionally generated (by setting the `AMASK` bit in the **FIM** register) to alert software developers of poorly behaving software during the development and debug phases.

An access that attempts to read an RE-protected block is prohibited. Such accesses return data filled with all 0s. A controller interrupt may be optionally generated to alert software developers of poorly behaving software during the development and debug phases.

The factory settings for the **FMPREn** and **FMPPEn** registers are a value of 1 for all implemented banks. This implements a policy of open access and programmability. The register bits may be changed by writing the specific register bit. The changes are not permanent until the register is committed (saved), at which point the bit change is permanent. If a bit is changed from a 1 to a 0 and not committed, it may be restored by executing a power-on reset sequence. Details on programming these bits are discussed in “Nonvolatile Register Programming” on page 135.

8.3 Flash Memory Initialization and Configuration

8.3.1 Flash Programming

The Stellaris[®] devices provide a user-friendly interface for flash programming. All erase/program operations are handled via three registers: **FMA**, **FMD**, and **FMC**.

8.3.1.1 To program a 32-bit word

1. Write source data to the **FMD** register.
2. Write the target address to the **FMA** register.
3. Write the flash write key and the `WRITE` bit (a value of 0xA442.0001) to the **FMC** register.
4. Poll the **FMC** register until the `WRITE` bit is cleared.

8.3.1.2 To perform an erase of a 1-KB page

1. Write the page address to the **FMA** register.
2. Write the flash write key and the `ERASE` bit (a value of 0xA442.0002) to the **FMC** register.
3. Poll the **FMC** register until the `ERASE` bit is cleared.

8.3.1.3 To perform a mass erase of the flash

1. Write the flash write key and the `MERASE` bit (a value of 0xA442.0004) to the **FMC** register.
2. Poll the **FMC** register until the `MERASE` bit is cleared.

8.3.2 Nonvolatile Register Programming

This section discusses how to update registers that are resident within the flash memory itself. These registers exist in a separate space from the main flash array and are not affected by an ERASE or MASS ERASE operation. These nonvolatile registers are updated by using the `COMT` bit in the **FMC** register to activate a write operation. For the **USER_DBG** register, the data to be written must be loaded into the **FMD** register before it is "committed". All other registers are R/W and can have their operation tried before committing them to nonvolatile memory.

Important: These registers can only have bits changed from 1 to 0 by the user and there is no mechanism for the user to erase them back to a 1 value.

In addition, the **USER_REG0**, **USER_REG1**, and **USER_DBG** use bit 31 (^{NW}) of their respective registers to indicate that they are available for user write. These three registers can only be written once whereas the flash protection registers may be written multiple times. Table 8-2 on page 135 provides the FMA address required for commitment of each of the registers and the source of the data to be written when the `COMT` bit of the **FMC** register is written with a value of 0xA442.0008. After writing the `COMT` bit, the user may poll the **FMC** register to wait for the commit operation to complete.

Table 8-2. Flash Resident Registers^a

Register to be Committed	FMA Value	Data Source
FMPRE0	0x0000.0000	FMPRE0
FMPRE1	0x0000.0002	FMPRE1
FMPRE2	0x0000.0004	FMPRE2
FMPRE3	0x0000.0008	FMPRE3
FMPPE0	0x0000.0001	FMPPE0
FMPPE1	0x0000.0003	FMPPE1
FMPPE2	0x0000.0005	FMPPE2
FMPPE3	0x0000.0007	FMPPE3
USER_REG0	0x8000.0000	USER_REG0
USER_REG1	0x8000.0001	USER_REG1
USER_DBG	0x7510.0000	FMD

a. Which FMPREn and FMPPEn registers are available depend on the flash size of your particular Stellaris[®] device.

8.4 Register Map

Table 8-3 on page 135 lists the Flash memory and control registers. The offset listed is a hexadecimal increment to the register's address. The **FMA**, **FMD**, **FMC**, **FCRIS**, **FCIM**, and **FCMISC** registers are relative to the Flash control base address of 0x400F.D000. The **FMPREn**, **FMPPEn**, **USECRL**, **USER_DBG**, and **USER_REGn** registers are relative to the System Control base address of 0x400F.E000.

Table 8-3. Flash Register Map

Offset	Name	Type	Reset	Description	See page
Flash Control Offset					
0x000	FMA	R/W	0x0000.0000	Flash Memory Address	137

Offset	Name	Type	Reset	Description	See page
0x004	FMD	R/W	0x0000.0000	Flash Memory Data	138
0x008	FMC	R/W	0x0000.0000	Flash Memory Control	139
0x00C	FCRIS	RO	0x0000.0000	Flash Controller Raw Interrupt Status	141
0x010	FCIM	R/W	0x0000.0000	Flash Controller Interrupt Mask	142
0x014	FCMISC	R/W1C	0x0000.0000	Flash Controller Masked Interrupt Status and Clear	143
System Control Offset					
0x130	FMPRE0	R/W	0xFFFF.FFFF	Flash Memory Protection Read Enable 0	145
0x200	FMPRE0	R/W	0xFFFF.FFFF	Flash Memory Protection Read Enable 0	145
0x134	FMPPE0	R/W	0xFFFF.FFFF	Flash Memory Protection Program Enable 0	146
0x400	FMPPE0	R/W	0xFFFF.FFFF	Flash Memory Protection Program Enable 0	146
0x140	USECRL	R/W	0x31	USec Reload	144
0x1D0	USER_DBG	R/W	0xFFFF.FFFE	User Debug	147
0x1E0	USER_REG0	R/W	0xFFFF.FFFF	User Register 0	148
0x1E4	USER_REG1	R/W	0xFFFF.FFFF	User Register 1	149
0x204	FMPRE1	R/W	0xFFFF.FFFF	Flash Memory Protection Read Enable 1	150
0x208	FMPRE2	R/W	0xFFFF.FFFF	Flash Memory Protection Read Enable 2	151
0x20C	FMPRE3	R/W	0xFFFF.FFFF	Flash Memory Protection Read Enable 3	152
0x404	FMPPE1	R/W	0xFFFF.FFFF	Flash Memory Protection Program Enable 1	153
0x408	FMPPE2	R/W	0xFFFF.FFFF	Flash Memory Protection Program Enable 2	154
0x40C	FMPPE3	R/W	0xFFFF.FFFF	Flash Memory Protection Program Enable 3	155

8.5 Flash Register Descriptions (Flash Control Offset)

The remainder of this section lists and describes the Flash Memory registers, in numerical order by address offset. Registers in this section are relative to the Flash control base address of 0x400F.D000.

Register 1: Flash Memory Address (FMA), offset 0x000

During a write operation, this register contains a 4-byte-aligned address and specifies where the data is written. During erase operations, this register contains a 1 KB-aligned address and specifies which page is erased. Note that the alignment requirements must be met by software or the results of the operation are unpredictable.

Flash Memory Address (FMA)

Base 0x400F.D000

Offset 0x000

Type R/W, reset 0x0000.0000

	31	30	29	28	27	26	25	24	23	22	21	20	19	18	17	16
	reserved														OFFSET	
Type	RO	RO	RO	RO	RO	RO	RO	RO	RO	RO	RO	RO	RO	RO	R/W	R/W
Reset	0	0	0	0	0	0	0	0	0	0	0	0	0	0	0	0
	15	14	13	12	11	10	9	8	7	6	5	4	3	2	1	0
	OFFSET															
Type	R/W	R/W	R/W	R/W	R/W	R/W	R/W	R/W	R/W	R/W	R/W	R/W	R/W	R/W	R/W	R/W
Reset	0	0	0	0	0	0	0	0	0	0	0	0	0	0	0	0

Bit/Field	Name	Type	Reset	Description
31:18	reserved	RO	0x0	Software should not rely on the value of a reserved bit. To provide compatibility with future products, the value of a reserved bit should be preserved across a read-modify-write operation.
17:0	OFFSET	R/W	0x0	Address Offset Address offset in flash where operation is performed, except for nonvolatile registers (see "Nonvolatile Register Programming" on page 135 for details on values for this field).

Register 2: Flash Memory Data (FMD), offset 0x004

This register contains the data to be written during the programming cycle or read during the read cycle. Note that the contents of this register are undefined for a read access of an execute-only block. This register is not used during the erase cycles.

Flash Memory Data (FMD)

Base 0x400F.D000

Offset 0x004

Type R/W, reset 0x0000.0000

	31	30	29	28	27	26	25	24	23	22	21	20	19	18	17	16
	DATA															
Type	R/W	R/W	R/W	R/W	R/W	R/W	R/W	R/W	R/W	R/W	R/W	R/W	R/W	R/W	R/W	R/W
Reset	0	0	0	0	0	0	0	0	0	0	0	0	0	0	0	0
	15	14	13	12	11	10	9	8	7	6	5	4	3	2	1	0
	DATA															
Type	R/W	R/W	R/W	R/W	R/W	R/W	R/W	R/W	R/W	R/W	R/W	R/W	R/W	R/W	R/W	R/W
Reset	0	0	0	0	0	0	0	0	0	0	0	0	0	0	0	0

Bit/Field	Name	Type	Reset	Description
31:0	DATA	R/W	0x0	Data Value Data value for write operation.

Register 3: Flash Memory Control (FMC), offset 0x008

When this register is written, the flash controller initiates the appropriate access cycle for the location specified by the **Flash Memory Address (FMA)** register (see page 137). If the access is a write access, the data contained in the **Flash Memory Data (FMD)** register (see page 138) is written.

This is the final register written and initiates the memory operation. There are four control bits in the lower byte of this register that, when set, initiate the memory operation. The most used of these register bits are the `ERASE` and `WRITE` bits.

It is a programming error to write multiple control bits and the results of such an operation are unpredictable.

Flash Memory Control (FMC)

Base 0x400F.D000

Offset 0x008

Type R/W, reset 0x0000.0000

	31	30	29	28	27	26	25	24	23	22	21	20	19	18	17	16
	WRKEY															
Type	WO	WO	WO	WO	WO	WO	WO	WO	WO	WO	WO	WO	WO	WO	WO	WO
Reset	0	0	0	0	0	0	0	0	0	0	0	0	0	0	0	0
	15	14	13	12	11	10	9	8	7	6	5	4	3	2	1	0
	reserved												COMT	MERASE	ERASE	WRITE
Type	RO	RO	RO	RO	RO	RO	RO	RO	RO	RO	RO	RO	R/W	R/W	R/W	R/W
Reset	0	0	0	0	0	0	0	0	0	0	0	0	0	0	0	0

Bit/Field	Name	Type	Reset	Description
31:16	WRKEY	WO	0x0	Flash Write Key This field contains a write key, which is used to minimize the incidence of accidental flash writes. The value 0xA442 must be written into this field for a write to occur. Writes to the FMC register without this <code>WRKEY</code> value are ignored. A read of this field returns the value 0.
15:4	reserved	RO	0x0	Software should not rely on the value of a reserved bit. To provide compatibility with future products, the value of a reserved bit should be preserved across a read-modify-write operation.
3	COMT	R/W	0	Commit Register Value Commit (write) of register value to nonvolatile storage. A write of 0 has no effect on the state of this bit. If read, the state of the previous commit access is provided. If the previous commit access is complete, a 0 is returned; otherwise, if the commit access is not complete, a 1 is returned. This can take up to 50 μ s.
2	MERASE	R/W	0	Mass Erase Flash Memory If this bit is set, the flash main memory of the device is all erased. A write of 0 has no effect on the state of this bit. If read, the state of the previous mass erase access is provided. If the previous mass erase access is complete, a 0 is returned; otherwise, if the previous mass erase access is not complete, a 1 is returned. This can take up to 250 ms.

Bit/Field	Name	Type	Reset	Description
1	ERASE	R/W	0	<p>Erase a Page of Flash Memory</p> <p>If this bit is set, the page of flash main memory as specified by the contents of FMA is erased. A write of 0 has no effect on the state of this bit.</p> <p>If read, the state of the previous erase access is provided. If the previous erase access is complete, a 0 is returned; otherwise, if the previous erase access is not complete, a 1 is returned.</p> <p>This can take up to 25 ms.</p>
0	WRITE	R/W	0	<p>Write a Word into Flash Memory</p> <p>If this bit is set, the data stored in FMD is written into the location as specified by the contents of FMA. A write of 0 has no effect on the state of this bit.</p> <p>If read, the state of the previous write update is provided. If the previous write access is complete, a 0 is returned; otherwise, if the write access is not complete, a 1 is returned.</p> <p>This can take up to 50 μs.</p>

Register 4: Flash Controller Raw Interrupt Status (FCRIS), offset 0x00C

This register indicates that the flash controller has an interrupt condition. An interrupt is only signaled if the corresponding **FCIM** register bit is set.

Flash Controller Raw Interrupt Status (FCRIS)

Base 0x400F.D000

Offset 0x00C

Type RO, reset 0x0000.0000

	31	30	29	28	27	26	25	24	23	22	21	20	19	18	17	16
	reserved															
Type	RO	RO	RO	RO	RO	RO	RO	RO	RO	RO	RO	RO	RO	RO	RO	RO
Reset	0	0	0	0	0	0	0	0	0	0	0	0	0	0	0	0
	15	14	13	12	11	10	9	8	7	6	5	4	3	2	1	0
	reserved														PRIS	ARIS
Type	RO	RO	RO	RO	RO	RO	RO	RO	RO	RO	RO	RO	RO	RO	RO	RO
Reset	0	0	0	0	0	0	0	0	0	0	0	0	0	0	0	0

Bit/Field	Name	Type	Reset	Description
31:2	reserved	RO	0x00	Software should not rely on the value of a reserved bit. To provide compatibility with future products, the value of a reserved bit should be preserved across a read-modify-write operation.
1	PRIS	RO	0	<p>Programming Raw Interrupt Status</p> <p>This bit indicates the current state of the programming cycle. If set, the programming cycle completed; if cleared, the programming cycle has not completed. Programming cycles are either write or erase actions generated through the Flash Memory Control (FMC) register bits (see page 139).</p>
0	ARIS	RO	0	<p>Access Raw Interrupt Status</p> <p>This bit indicates if the flash was improperly accessed. If set, the program tried to access the flash counter to the policy as set in the Flash Memory Protection Read Enable (FMPREn) and Flash Memory Protection Program Enable (FMPPEn) registers. Otherwise, no access has tried to improperly access the flash.</p>

Register 5: Flash Controller Interrupt Mask (FCIM), offset 0x010

This register controls whether the flash controller generates interrupts to the controller.

Flash Controller Interrupt Mask (FCIM)

Base 0x400F.D000

Offset 0x010

Type R/W, reset 0x0000.0000

	31	30	29	28	27	26	25	24	23	22	21	20	19	18	17	16	
	reserved																
Type	RO	RO	RO	RO	RO	RO	RO	RO	RO	RO	RO	RO	RO	RO	RO	RO	
Reset	0	0	0	0	0	0	0	0	0	0	0	0	0	0	0	0	
	15	14	13	12	11	10	9	8	7	6	5	4	3	2	1	0	
	reserved														PMASK	AMASK	
Type	RO	RO	RO	RO	RO	RO	RO	RO	RO	RO	RO	RO	RO	RO	RO	R/W	R/W
Reset	0	0	0	0	0	0	0	0	0	0	0	0	0	0	0	0	0

Bit/Field	Name	Type	Reset	Description
31:2	reserved	RO	0x00	Software should not rely on the value of a reserved bit. To provide compatibility with future products, the value of a reserved bit should be preserved across a read-modify-write operation.
1	PMASK	R/W	0	<p>Programming Interrupt Mask</p> <p>This bit controls the reporting of the programming raw interrupt status to the controller. If set, a programming-generated interrupt is promoted to the controller. Otherwise, interrupts are recorded but suppressed from the controller.</p>
0	AMASK	R/W	0	<p>Access Interrupt Mask</p> <p>This bit controls the reporting of the access raw interrupt status to the controller. If set, an access-generated interrupt is promoted to the controller. Otherwise, interrupts are recorded but suppressed from the controller.</p>

Register 6: Flash Controller Masked Interrupt Status and Clear (FCMISC), offset 0x014

This register provides two functions. First, it reports the cause of an interrupt by indicating which interrupt source or sources are signalling the interrupt. Second, it serves as the method to clear the interrupt reporting.

Flash Controller Masked Interrupt Status and Clear (FCMISC)

Base 0x400F.D000

Offset 0x014

Type R/W1C, reset 0x0000.0000

	31	30	29	28	27	26	25	24	23	22	21	20	19	18	17	16
	reserved															
Type	RO	RO	RO	RO	RO	RO	RO	RO	RO	RO	RO	RO	RO	RO	RO	RO
Reset	0	0	0	0	0	0	0	0	0	0	0	0	0	0	0	0
	15	14	13	12	11	10	9	8	7	6	5	4	3	2	1	0
	reserved														PMISC	AMISC
Type	RO	RO	RO	RO	RO	RO	RO	RO	RO	RO	RO	RO	RO	RO	R/W1C	R/W1C
Reset	0	0	0	0	0	0	0	0	0	0	0	0	0	0	0	0

Bit/Field	Name	Type	Reset	Description
31:2	reserved	RO	0x00	Software should not rely on the value of a reserved bit. To provide compatibility with future products, the value of a reserved bit should be preserved across a read-modify-write operation.
1	PMISC	R/W1C	0	<p>Programming Masked Interrupt Status and Clear</p> <p>This bit indicates whether an interrupt was signaled because a programming cycle completed and was not masked. This bit is cleared by writing a 1. The <code>PRIS</code> bit in the <code>FCRIS</code> register (see page 141) is also cleared when the <code>PMISC</code> bit is cleared.</p>
0	AMISC	R/W1C	0	<p>Access Masked Interrupt Status and Clear</p> <p>This bit indicates whether an interrupt was signaled because an improper access was attempted and was not masked. This bit is cleared by writing a 1. The <code>ARIS</code> bit in the <code>FCRIS</code> register is also cleared when the <code>AMISC</code> bit is cleared.</p>

8.6 Flash Register Descriptions (System Control Offset)

The remainder of this section lists and describes the Flash Memory registers, in numerical order by address offset. Registers in this section are relative to the System Control base address of 0x400F.E000.

Register 7: USec Reload (USECRL), offset 0x140

Note: Offset is relative to System Control base address of 0x400F.E000

This register is provided as a means of creating a 1- μ s tick divider reload value for the flash controller. The internal flash has specific minimum and maximum requirements on the length of time the high voltage write pulse can be applied. It is required that this register contain the operating frequency (in MHz -1) whenever the flash is being erased or programmed. The user is required to change this value if the clocking conditions are changed for a flash erase/program operation.

USec Reload (USECRL)

Base 0x400F.E000
 Offset 0x140
 Type R/W, reset 0x31

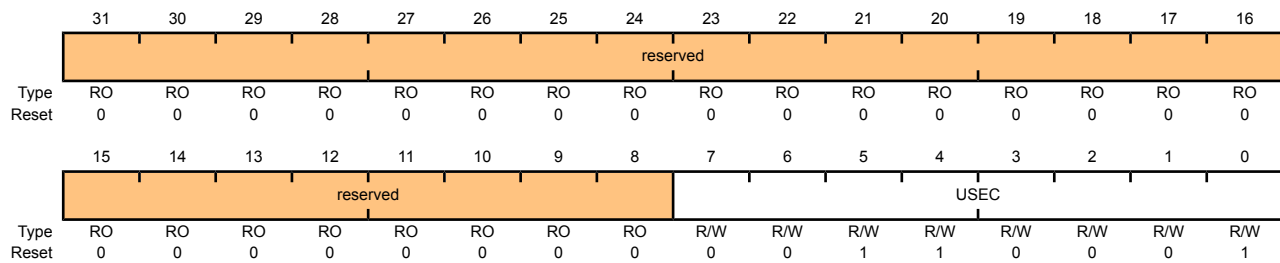

Bit/Field	Name	Type	Reset	Description
31:8	reserved	RO	0x00	Software should not rely on the value of a reserved bit. To provide compatibility with future products, the value of a reserved bit should be preserved across a read-modify-write operation.
7:0	USEC	R/W	0x31	Microsecond Reload Value MHz -1 of the controller clock when the flash is being erased or programmed. USEC should be set to 0x31 (50 MHz) whenever the flash is being erased or programmed.

Register 8: Flash Memory Protection Read Enable 0 (FMPRE0), offset 0x130 and 0x200

Note: This register is aliased for backwards compatibility.

Note: Offset is relative to System Control base address of 0x400FE000.

This register stores the read-only protection bits for each 2-KB flash block (**FMPPEn** stores the execute-only bits). This register is loaded during the power-on reset sequence. The factory settings for the **FMPREN** and **FMPPEn** registers are a value of 1 for all implemented banks. This achieves a policy of open access and programmability. The register bits may be changed by writing the specific register bit. However, this register is R/W0; the user can only change the protection bit from a 1 to a 0 (and may NOT change a 0 to a 1). The changes are not permanent until the register is committed (saved), at which point the bit change is permanent. If a bit is changed from a 1 to a 0 and not committed, it may be restored by executing a power-on reset sequence. For additional information, see the "Flash Memory Protection" section.

Flash Memory Protection Read Enable 0 (FMPRE0)

Base 0x400F.D000

Offset 0x130 and 0x200

Type R/W, reset 0xFFFF.FFFF

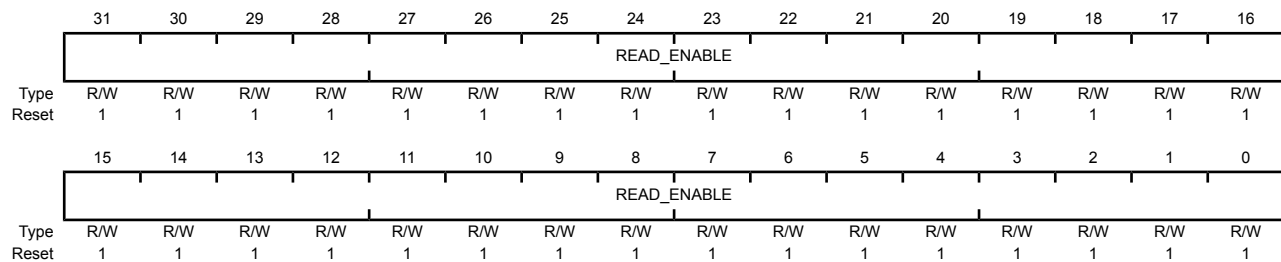

Bit/Field	Name	Type	Reset	Description
-----------	------	------	-------	-------------

31:0	READ_ENABLE	R/W	0xFFFFFFFF	Flash Read Enable
------	-------------	-----	------------	-------------------

Enables 2-KB flash blocks to be executed or read. The policies may be combined as shown in the table "Flash Protection Policy Combinations".

Value	Description
-------	-------------

0xFFFFFFFF	Enables 256 KB of flash.
------------	--------------------------

Register 9: Flash Memory Protection Program Enable 0 (FMPPE0), offset 0x134 and 0x400

Note: This register is aliased for backwards compatability.

Note: Offset is relative to System Control base address of 0x400FE000.

This register stores the execute-only protection bits for each 2-KB flash block (**FMPREN** stores the execute-only bits). This register is loaded during the power-on reset sequence. The factory settings for the **FMPREN** and **FMPPEN** registers are a value of 1 for all implemented banks. This achieves a policy of open access and programmability. The register bits may be changed by writing the specific register bit. However, this register is R/W0; the user can only change the protection bit from a 1 to a 0 (and may NOT change a 0 to a 1). The changes are not permanent until the register is committed (saved), at which point the bit change is permanent. If a bit is changed from a 1 to a 0 and not committed, it may be restored by executing a power-on reset sequence. For additional information, see the "Flash Memory Protection" section.

Flash Memory Protection Program Enable 0 (FMPPE0)

Base 0x400F.D000
 Offset 0x134 and 0x400
 Type R/W, reset 0xFFFF.FFFF

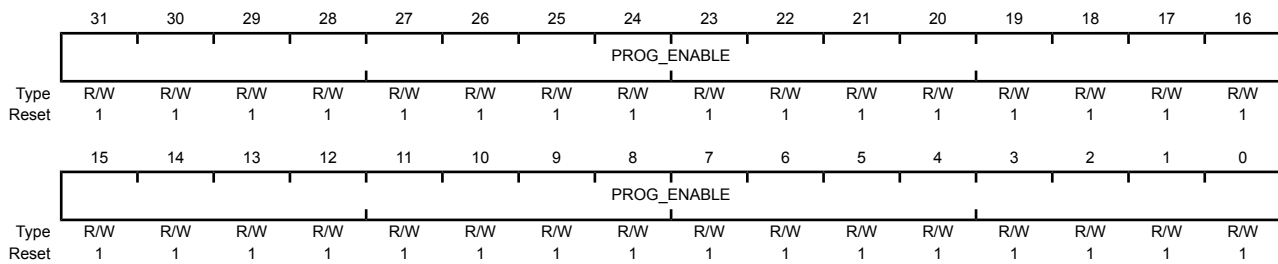

Bit/Field	Name	Type	Reset	Description
31:0	PROG_ENABLE	R/W	0xFFFFFFFF	Flash Programming Enable Configures 2-KB flash blocks to be execute only. The policies may be combined as shown in the table "Flash Protection Policy Combinations". Value Description 0xFFFFFFFF Enables 256 KB of flash.

Register 10: User Debug (USER_DBG), offset 0x1D0

Note: Offset is relative to System Control base address of 0x400FE000.

This register provides a write-once mechanism to disable external debugger access to the device in addition to 27 additional bits of user-defined data. The `DBG0` bit (bit 0) is set to 0 from the factory and the `DBG1` bit (bit 1) is set to 1, which enables external debuggers. Changing the `DBG1` bit to 0 disables any external debugger access to the device permanently, starting with the next power-up cycle of the device. The `NOTWRITTEN` bit (bit 31) indicates that the register is available to be written and is controlled through hardware to ensure that the register is only written once.

User Debug (USER_DBG)

Base 0x400F.E000

Offset 0x1D0

Type R/W, reset 0xFFFF.FFFE

	31	30	29	28	27	26	25	24	23	22	21	20	19	18	17	16	
	NW	DATA															
Type	R/W	R/W	R/W	R/W	R/W	R/W	R/W	R/W	R/W	R/W	R/W	R/W	R/W	R/W	R/W	R/W	
Reset	1	1	1	1	1	1	1	1	1	1	1	1	1	1	1	1	
	15	14	13	12	11	10	9	8	7	6	5	4	3	2	1	0	
	DATA															DBG1	DBG0
Type	R/W	R/W	R/W	R/W	R/W	R/W	R/W	R/W	R/W	R/W	R/W	R/W	R/W	R/W	R/W	R/W	R/W
Reset	1	1	1	1	1	1	1	1	1	1	1	1	1	1	1	1	0

Bit/Field	Name	Type	Reset	Description
31	NW	R/W	1	User Debug Not Written Specifies that this 32-bit dword has not been written.
30:2	DATA	R/W	0x1FFFFFFF	User Data Contains the user data value. This field is initialized to all 1s and can only be written once.
1	DBG1	R/W	1	Debug Control 1 The <code>DBG1</code> bit must be 1 and <code>DBG0</code> must be 0 for debug to be available.
0	DBG0	R/W	0	Debug Control 0 The <code>DBG1</code> bit must be 1 and <code>DBG0</code> must be 0 for debug to be available.

Register 11: User Register 0 (USER_REG0), offset 0x1E0

Note: Offset is relative to System Control base address of 0x400FE000.

This register provides 31 bits of user-defined data that is non-volatile and can only be written once. Bit 31 indicates that the register is available to be written and is controlled through hardware to ensure that the register is only written once. The write-once characteristics of this register are useful for keeping static information like communication addresses that need to be unique per part and would otherwise require an external EEPROM or other non-volatile device.

User Register 0 (USER_REG0)

Base 0x400F.E000

Offset 0x1E0

Type R/W, reset 0xFFFFFFFF

	31	30	29	28	27	26	25	24	23	22	21	20	19	18	17	16
	NW	DATA														
Type	R/W	R/W	R/W	R/W	R/W	R/W	R/W	R/W	R/W	R/W	R/W	R/W	R/W	R/W	R/W	R/W
Reset	1	1	1	1	1	1	1	1	1	1	1	1	1	1	1	1
	15	14	13	12	11	10	9	8	7	6	5	4	3	2	1	0
	DATA															
Type	R/W	R/W	R/W	R/W	R/W	R/W	R/W	R/W	R/W	R/W	R/W	R/W	R/W	R/W	R/W	R/W
Reset	1	1	1	1	1	1	1	1	1	1	1	1	1	1	1	1

Bit/Field	Name	Type	Reset	Description
31	NW	R/W	1	Not Written Specifies that this 32-bit dword has not been written.
30:0	DATA	R/W	0x7FFFFFFF	User Data Contains the user data value. This field is initialized to all 1s and can only be written once.

Register 12: User Register 1 (USER_REG1), offset 0x1E4

Note: Offset is relative to System Control base address of 0x400FE000.

This register provides 31 bits of user-defined data that is non-volatile and can only be written once. Bit 31 indicates that the register is available to be written and is controlled through hardware to ensure that the register is only written once. The write-once characteristics of this register are useful for keeping static information like communication addresses that need to be unique per part and would otherwise require an external EEPROM or other non-volatile device.

User Register 1 (USER_REG1)

Base 0x400F.E000

Offset 0x1E4

Type R/W, reset 0xFFFF.FFFF

	31	30	29	28	27	26	25	24	23	22	21	20	19	18	17	16
	NW	DATA														
Type	R/W	R/W	R/W	R/W	R/W	R/W	R/W	R/W	R/W	R/W	R/W	R/W	R/W	R/W	R/W	R/W
Reset	1	1	1	1	1	1	1	1	1	1	1	1	1	1	1	1
	15	14	13	12	11	10	9	8	7	6	5	4	3	2	1	0
	DATA															
Type	R/W	R/W	R/W	R/W	R/W	R/W	R/W	R/W	R/W	R/W	R/W	R/W	R/W	R/W	R/W	R/W
Reset	1	1	1	1	1	1	1	1	1	1	1	1	1	1	1	1

Bit/Field	Name	Type	Reset	Description
31	NW	R/W	1	Not Written Specifies that this 32-bit dword has not been written.
30:0	DATA	R/W	0x7FFFFFFF	User Data Contains the user data value. This field is initialized to all 1s and can only be written once.

Register 13: Flash Memory Protection Read Enable 1 (FMPRE1), offset 0x204

Note: Offset is relative to System Control base address of 0x400FE000.

This register stores the read-only protection bits for each 2-KB flash block (**FMPPEn** stores the execute-only bits). This register is loaded during the power-on reset sequence. The factory settings for the **FMPREN** and **FMPPEn** registers are a value of 1 for all implemented banks. This achieves a policy of open access and programmability. The register bits may be changed by writing the specific register bit. However, this register is R/W0; the user can only change the protection bit from a 1 to a 0 (and may NOT change a 0 to a 1). The changes are not permanent until the register is committed (saved), at which point the bit change is permanent. If a bit is changed from a 1 to a 0 and not committed, it may be restored by executing a power-on reset sequence. For additional information, see the "Flash Memory Protection" section.

Flash Memory Protection Read Enable 1 (FMPRE1)

Base 0x400F.E000

Offset 0x204

Type R/W, reset 0xFFFF.FFFF

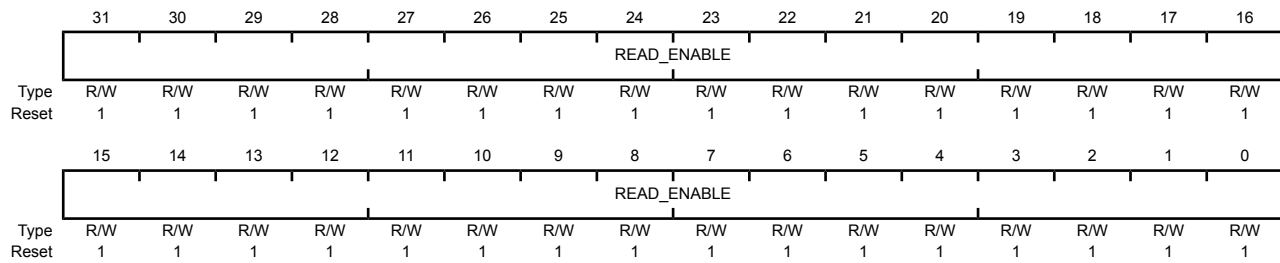

Bit/Field	Name	Type	Reset	Description
-----------	------	------	-------	-------------

31:0	READ_ENABLE	R/W	0xFFFFFFFF	Flash Read Enable
------	-------------	-----	------------	-------------------

Enables 2-KB flash blocks to be executed or read. The policies may be combined as shown in the table "Flash Protection Policy Combinations".

Value	Description
-------	-------------

0xFFFFFFFF	Enables 256 KB of flash.
------------	--------------------------

Register 14: Flash Memory Protection Read Enable 2 (FMPRE2), offset 0x208

Note: Offset is relative to System Control base address of 0x400FE000.

This register stores the read-only protection bits for each 2-KB flash block (**FMPPEn** stores the execute-only bits). This register is loaded during the power-on reset sequence. The factory settings for the **FMPREN** and **FMPPEn** registers are a value of 1 for all implemented banks. This achieves a policy of open access and programmability. The register bits may be changed by writing the specific register bit. However, this register is R/W0; the user can only change the protection bit from a 1 to a 0 (and may NOT change a 0 to a 1). The changes are not permanent until the register is committed (saved), at which point the bit change is permanent. If a bit is changed from a 1 to a 0 and not committed, it may be restored by executing a power-on reset sequence. For additional information, see the "Flash Memory Protection" section.

Flash Memory Protection Read Enable 2 (FMPRE2)

Base 0x400F.E000

Offset 0x208

Type R/W, reset 0xFFFF.FFFF

	31	30	29	28	27	26	25	24	23	22	21	20	19	18	17	16
	READ_ENABLE															
Type	R/W	R/W	R/W	R/W	R/W	R/W	R/W	R/W	R/W	R/W	R/W	R/W	R/W	R/W	R/W	R/W
Reset	1	1	1	1	1	1	1	1	1	1	1	1	1	1	1	1
	15	14	13	12	11	10	9	8	7	6	5	4	3	2	1	0
	READ_ENABLE															
Type	R/W	R/W	R/W	R/W	R/W	R/W	R/W	R/W	R/W	R/W	R/W	R/W	R/W	R/W	R/W	R/W
Reset	1	1	1	1	1	1	1	1	1	1	1	1	1	1	1	1

Bit/Field	Name	Type	Reset	Description
31:0	READ_ENABLE	R/W	0xFFFFFFFF	Flash Read Enable

Enables 2-KB flash blocks to be executed or read. The policies may be combined as shown in the table "Flash Protection Policy Combinations".

Value	Description
0xFFFFFFFF	Enables 256 KB of flash.

Register 15: Flash Memory Protection Read Enable 3 (FMPRE3), offset 0x20C

Note: Offset is relative to System Control base address of 0x400FE000.

This register stores the read-only protection bits for each 2-KB flash block (**FMPPEn** stores the execute-only bits). This register is loaded during the power-on reset sequence. The factory settings for the **FMPREN** and **FMPPEn** registers are a value of 1 for all implemented banks. This achieves a policy of open access and programmability. The register bits may be changed by writing the specific register bit. However, this register is R/W0; the user can only change the protection bit from a 1 to a 0 (and may NOT change a 0 to a 1). The changes are not permanent until the register is committed (saved), at which point the bit change is permanent. If a bit is changed from a 1 to a 0 and not committed, it may be restored by executing a power-on reset sequence. For additional information, see the "Flash Memory Protection" section.

Flash Memory Protection Read Enable 3 (FMPRE3)

Base 0x400F.E000
 Offset 0x20C
 Type R/W, reset 0xFFFF.FFFF

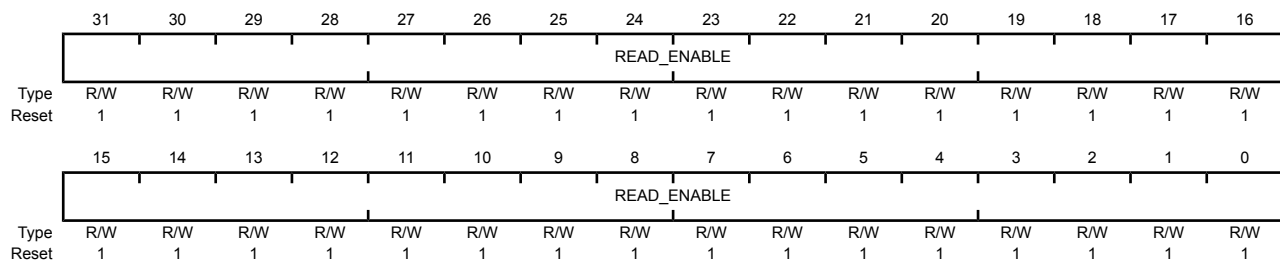

Bit/Field	Name	Type	Reset	Description
31:0	READ_ENABLE	R/W	0xFFFFFFFF	Flash Read Enable Enables 2-KB flash blocks to be executed or read. The policies may be combined as shown in the table "Flash Protection Policy Combinations". Value Description 0xFFFFFFFF Enables 256 KB of flash.

Register 16: Flash Memory Protection Program Enable 1 (FMPPE1), offset 0x404

Note: Offset is relative to System Control base address of 0x400FE000.

This register stores the execute-only protection bits for each 2-KB flash block (**FMPPE_n** stores the execute-only bits). This register is loaded during the power-on reset sequence. The factory settings for the **FMPPE_n** and **FMPPE_n** registers are a value of 1 for all implemented banks. This achieves a policy of open access and programmability. The register bits may be changed by writing the specific register bit. However, this register is R/W0; the user can only change the protection bit from a 1 to a 0 (and may NOT change a 0 to a 1). The changes are not permanent until the register is committed (saved), at which point the bit change is permanent. If a bit is changed from a 1 to a 0 and not committed, it may be restored by executing a power-on reset sequence. For additional information, see the "Flash Memory Protection" section.

Flash Memory Protection Program Enable 1 (FMPPE1)

Base 0x400F.E000

Offset 0x404

Type R/W, reset 0xFFFF.FFFF

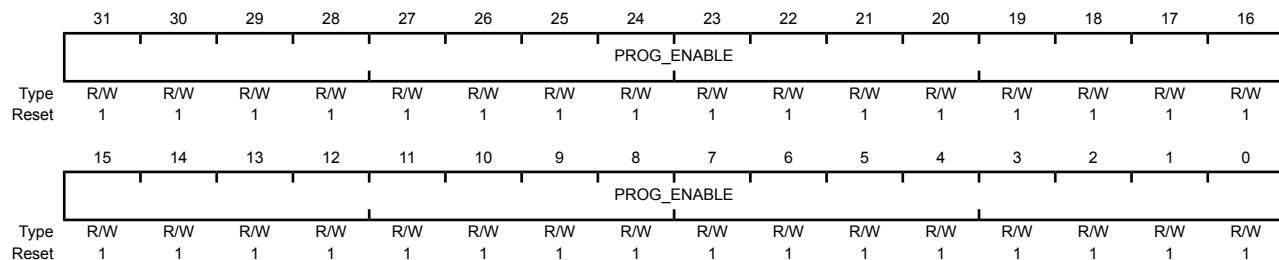

Bit/Field	Name	Type	Reset	Description
31:0	PROG_ENABLE	R/W	0xFFFFFFFF	Flash Programming Enable

Configures 2-KB flash blocks to be execute only. The policies may be combined as shown in the table "Flash Protection Policy Combinations".

Value	Description
0xFFFFFFFF	Enables 256 KB of flash.

Register 17: Flash Memory Protection Program Enable 2 (FMPPE2), offset 0x408

Note: Offset is relative to System Control base address of 0x400FE000.

This register stores the execute-only protection bits for each 2-KB flash block (**FMPREn** stores the execute-only bits). This register is loaded during the power-on reset sequence. The factory settings for the **FMPREn** and **FMPPEn** registers are a value of 1 for all implemented banks. This achieves a policy of open access and programmability. The register bits may be changed by writing the specific register bit. However, this register is R/W0; the user can only change the protection bit from a 1 to a 0 (and may NOT change a 0 to a 1). The changes are not permanent until the register is committed (saved), at which point the bit change is permanent. If a bit is changed from a 1 to a 0 and not committed, it may be restored by executing a power-on reset sequence. For additional information, see the "Flash Memory Protection" section.

Flash Memory Protection Program Enable 2 (FMPPE2)

Base 0x400F.E000

Offset 0x408

Type R/W, reset 0xFFFF.FFFF

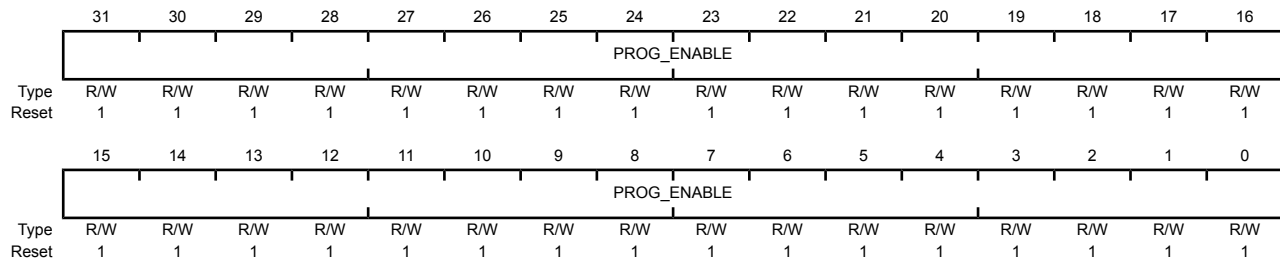

Bit/Field	Name	Type	Reset	Description
31:0	PROG_ENABLE	R/W	0xFFFFFFFF	Flash Programming Enable

Configures 2-KB flash blocks to be execute only. The policies may be combined as shown in the table "Flash Protection Policy Combinations".

Value	Description
0xFFFFFFFF	Enables 256 KB of flash.

Register 18: Flash Memory Protection Program Enable 3 (FMPPE3), offset 0x40C

Note: Offset is relative to System Control base address of 0x400FE000.

This register stores the execute-only protection bits for each 2-KB flash block (**FMPPEn** stores the execute-only bits). This register is loaded during the power-on reset sequence. The factory settings for the **FMPPEn** and **FMPPEn** registers are a value of 1 for all implemented banks. This achieves a policy of open access and programmability. The register bits may be changed by writing the specific register bit. However, this register is R/W0; the user can only change the protection bit from a 1 to a 0 (and may NOT change a 0 to a 1). The changes are not permanent until the register is committed (saved), at which point the bit change is permanent. If a bit is changed from a 1 to a 0 and not committed, it may be restored by executing a power-on reset sequence. For additional information, see the "Flash Memory Protection" section.

Flash Memory Protection Program Enable 3 (FMPPE3)

Base 0x400F.E000

Offset 0x40C

Type R/W, reset 0xFFFF.FFFF

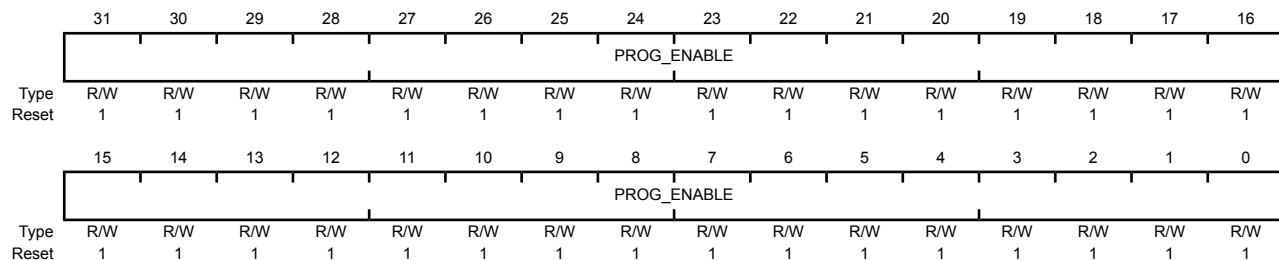

Bit/Field	Name	Type	Reset	Description
31:0	PROG_ENABLE	R/W	0xFFFFFFFF	Flash Programming Enable

Configures 2-KB flash blocks to be execute only. The policies may be combined as shown in the table "Flash Protection Policy Combinations".

Value	Description
0xFFFFFFFF	Enables 256 KB of flash.

9 General-Purpose Input/Outputs (GPIOs)

The GPIO module is composed of seven physical GPIO blocks, each corresponding to an individual GPIO port (Port A, Port B, Port C, Port D, Port E, Port F, and Port G,). The GPIO module is FiRM-compliant and supports 7-35 programmable input/output pins, depending on the peripherals being used.

The GPIO module has the following features:

- Programmable control for GPIO interrupts
 - Interrupt generation masking
 - Edge-triggered on rising, falling, or both
 - Level-sensitive on High or Low values
- 5-V-tolerant input/outputs
- Bit masking in both read and write operations through address lines
- Programmable control for GPIO pad configuration
 - Weak pull-up or pull-down resistors
 - 2-mA, 4-mA, and 8-mA pad drive
 - Slew rate control for the 8-mA drive
 - Open drain enables
 - Digital input enables

9.1 Functional Description

Important: All GPIO pins are tri-stated by default (**GPIOAFSEL=0**, **GPIODEN=0**, **GPIOPDR=0**, and **GPIOPUR=0**), with the exception of the five JTAG/SWD pins (**PB7** and **PC[3:0]**). The JTAG/SWD pins default to their JTAG/SWD functionality (**GPIOAFSEL=1**, **GPIODEN=1** and **GPIOPUR=1**). A Power-On-Reset (\overline{POR}) or asserting \overline{RST} puts both groups of pins back to their default state.

Each GPIO port is a separate hardware instantiation of the same physical block (see Figure 9-1 on page 157). The LM3S6916 microcontroller contains seven ports and thus seven of these physical GPIO blocks.

Figure 9-1. GPIO Port Block Diagram

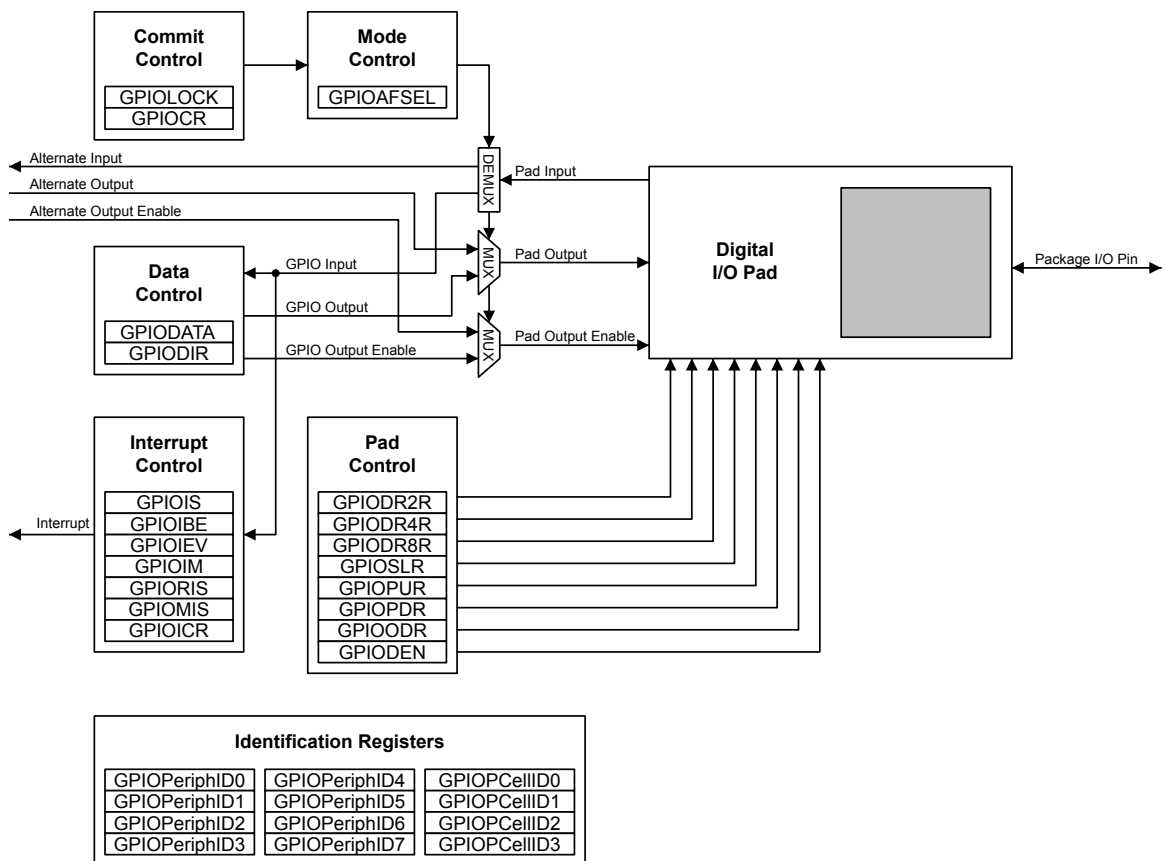

9.1.1 Data Control

The data control registers allow software to configure the operational modes of the GPIOs. The data direction register configures the GPIO as an input or an output while the data register either captures incoming data or drives it out to the pads.

9.1.1.1 Data Direction Operation

The **GPIO Direction (GPIODIR)** register (see page 164) is used to configure each individual pin as an input or output. When the data direction bit is set to 0, the GPIO is configured as an input and the corresponding data register bit will capture and store the value on the GPIO port. When the data direction bit is set to 1, the GPIO is configured as an output and the corresponding data register bit will be driven out on the GPIO port.

9.1.1.2 Data Register Operation

To aid in the efficiency of software, the GPIO ports allow for the modification of individual bits in the **GPIO Data (GPIODATA)** register (see page 163) by using bits [9:2] of the address bus as a mask. This allows software drivers to modify individual GPIO pins in a single instruction, without affecting the state of the other pins. This is in contrast to the "typical" method of doing a read-modify-write operation to set or clear an individual GPIO pin. To accommodate this feature, the **GPIODATA** register covers 256 locations in the memory map.

During a write, if the address bit associated with that data bit is set to 1, the value of the **GPIODATA** register is altered. If it is cleared to 0, it is left unchanged.

For example, writing a value of 0xEB to the address GPIODATA + 0x098 would yield as shown in Figure 9-2 on page 158, where u is data unchanged by the write.

Figure 9-2. GPIODATA Write Example

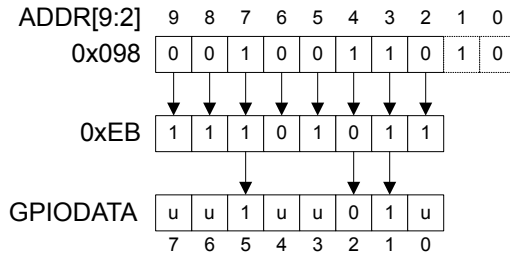

During a read, if the address bit associated with the data bit is set to 1, the value is read. If the address bit associated with the data bit is set to 0, it is read as a zero, regardless of its actual value. For example, reading address GPIODATA + 0x0C4 yields as shown in Figure 9-3 on page 158.

Figure 9-3. GPIODATA Read Example

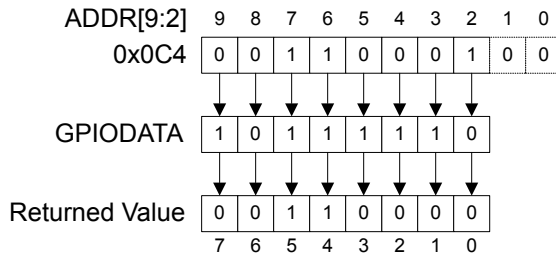

9.1.2 Interrupt Control

The interrupt capabilities of each GPIO port are controlled by a set of seven registers. With these registers, it is possible to select the source of the interrupt, its polarity, and the edge properties. When one or more GPIO inputs cause an interrupt, a single interrupt output is sent to the interrupt controller for the entire GPIO port. For edge-triggered interrupts, software must clear the interrupt to enable any further interrupts. For a level-sensitive interrupt, it is assumed that the external source holds the level constant for the interrupt to be recognized by the controller.

Three registers are required to define the edge or sense that causes interrupts:

- **GPIO Interrupt Sense (GPIOIS)** register (see page 165)
- **GPIO Interrupt Both Edges (GPIOIBE)** register (see page 166)
- **GPIO Interrupt Event (GPIOIEV)** register (see page 167)

Interrupts are enabled/disabled via the **GPIO Interrupt Mask (GPIOIM)** register (see page 168).

When an interrupt condition occurs, the state of the interrupt signal can be viewed in two locations: the **GPIO Raw Interrupt Status (GPIORIS)** and **GPIO Masked Interrupt Status (GPIOMIS)** registers (see page 169 and page 170). As the name implies, the **GPIOMIS** register only shows interrupt conditions that are allowed to be passed to the controller. The **GPIORIS** register indicates that a GPIO pin meets the conditions for an interrupt, but has not necessarily been sent to the controller.

In addition to providing GPIO functionality, PB4 can also be used as an external trigger for the ADC. If PB4 is configured as a non-masked interrupt pin (`GPIOIM` is set to 1), not only is an interrupt for PortB generated, but an external trigger signal is sent to the ADC. If the **ADC Event Multiplexer Select (ADCEMUX)** register is configured to use the external trigger, an ADC conversion is initiated.

If no other PortB pins are being used to generate interrupts, the ARM Integrated Nested Vectored Interrupt Controller (NVIC) Interrupt Set Enable (SETNA) register can disable the PortB interrupts and the ADC interrupt can be used to read back the converted data. Otherwise, the PortB interrupt handler needs to ignore and clear interrupts on B4, and wait for the ADC interrupt or the ADC interrupt needs to be disabled in the SETNA register and the PortB interrupt handler polls the ADC registers until the conversion is completed.

Interrupts are cleared by writing a 1 to the **GPIO Interrupt Clear (GPIOICR)** register (see page 171).

When programming the following interrupt control registers, the interrupts should be masked (`GPIOIM` set to 0). Writing any value to an interrupt control register (`GPIOIS`, `GPIOIBE`, or `GPIOIEV`) can generate a spurious interrupt if the corresponding bits are enabled.

9.1.3 Mode Control

The GPIO pins can be controlled by either hardware or software. When hardware control is enabled via the **GPIO Alternate Function Select (GPIOAFSEL)** register (see page 172), the pin state is controlled by its alternate function (that is, the peripheral). Software control corresponds to GPIO mode, where the `GPIODATA` register is used to read/write the corresponding pins.

9.1.4 Commit Control

The commit control registers provide a layer of protection against accidental programming of critical hardware peripherals. Writes to protected bits of the **GPIO Alternate Function Select (GPIOAFSEL)** register (see page 172) are not committed to storage unless the **GPIO Lock (GPIOLOCK)** register (see page 182) has been unlocked and the appropriate bits of the **GPIO Commit (GPIOCR)** register (see page 183) have been set to 1.

9.1.5 Pad Control

The pad control registers allow for GPIO pad configuration by software based on the application requirements. The pad control registers include the `GPIODR2R`, `GPIODR4R`, `GPIODR8R`, `GPIOODR`, `GPIOPUR`, `GPIOPDR`, `GPIOSLR`, and `GPIODEN` registers.

9.1.6 Identification

The identification registers configured at reset allow software to detect and identify the module as a GPIO block. The identification registers include the `GPIOPeriphID0-GIOPeriphID7` registers as well as the `GPIOCellIID0-GIOPCellIID3` registers.

9.2 Initialization and Configuration

To use the GPIO, the peripheral clock must be enabled by setting the appropriate GPIO Port bit field (`GPIOn`) in the **RCGC2** register.

On reset, all GPIO pins (except for the five JTAG pins) are configured out of reset to be undriven (tristate): `GPIOAFSEL=0`, `GPIODEN=0`, `GPIOPDR=0`, and `GPIOPUR=0`. Table 9-1 on page 160 shows all possible configurations of the GPIO pads and the control register settings required to achieve them. Table 9-2 on page 160 shows how a rising edge interrupt would be configured for pin 2 of a GPIO port.

Table 9-1. GPIO Pad Configuration Examples

Configuration	GPIO Register Bit Value ^a									
	AFSEL	DIR	ODR	DEN	PUR	PDR	DR2R	DR4R	DR8R	SLR
Digital Input (GPIO)	0	0	0	1	?	?	X	X	X	X
Digital Output (GPIO)	0	1	0	1	?	?	?	?	?	?
Open Drain Input (GPIO)	0	0	1	1	X	X	X	X	X	X
Open Drain Output (GPIO)	0	1	1	1	X	X	?	?	?	?
Open Drain Input/Output (I ² C)	1	X	1	1	X	X	?	?	?	?
Digital Input (Timer CCP)	1	X	0	1	?	?	X	X	X	X
Digital Output (PWM)	1	X	0	1	?	?	?	?	?	?
Digital Output (Timer PWM)	1	X	0	1	?	?	?	?	?	?
Digital Input/Output (SSI)	1	X	0	1	?	?	?	?	?	?
Digital Input/Output (UART)	1	X	0	1	?	?	?	?	?	?

a. X=Ignored (don't care bit)

?=Can be either 0 or 1, depending on the configuration

Table 9-2. GPIO Interrupt Configuration Example

Register	Desired Interrupt Event Trigger	Pin 2 Bit Value ^a							
		7	6	5	4	3	2	1	0
GPIOIS	0=edge 1=level	X	X	X	X	X	0	X	X
GPIOIBE	0=single edge 1=both edges	X	X	X	X	X	0	X	X
GPIOIEV	0=Low level, or negative edge 1=High level, or positive edge	X	X	X	X	X	1	X	X
GPIOIM	0=masked 1=not masked	0	0	0	0	0	1	0	0

a. X=Ignored (don't care bit)

9.3 Register Map

Table 9-3 on page 161 lists the GPIO registers. The offset listed is a hexadecimal increment to the register's address, relative to that GPIO port's base address:

- GPIO Port A: 0x4000.4000
- GPIO Port B: 0x4000.5000
- GPIO Port C: 0x4000.6000
- GPIO Port D: 0x4000.7000
- GPIO Port E: 0x4002.4000
- GPIO Port F: 0x4002.5000
- GPIO Port G: 0x4002.6000

Important: The GPIO registers in this chapter are duplicated in each GPIO block, however, depending on the block, all eight bits may not be connected to a GPIO pad. In those cases, writing to those unconnected bits has no effect and reading those unconnected bits returns no meaningful data.

Note: The default reset value for the **GPIOAFSEL**, **GPIOPUR**, and **GPIODEN** registers are 0x0000.0000 for all GPIO pins, with the exception of the five JTAG/SWD pins (**PB7** and **PC[3:0]**). These five pins default to JTAG/SWD functionality. Because of this, the default reset value of these registers for GPIO Port B is 0x0000.0080 while the default reset value for Port C is 0x0000.000F.

The default register type for the **GPIOCR** register is RO for all GPIO pins, with the exception of the five JTAG/SWD pins (**PB7** and **PC[3:0]**). These five pins are currently the only GPIOs that are protected by the **GPIOCR** register. Because of this, the register type for GPIO Port B7 and GPIO Port C[3:0] is R/W.

The default reset value for the **GPIOCR** register is 0x0000.00FF for all GPIO pins, with the exception of the five JTAG/SWD pins (**PB7** and **PC[3:0]**). To ensure that the JTAG port is not accidentally programmed as a GPIO, these five pins default to non-committable. Because of this, the default reset value of **GPIOCR** for GPIO Port B is 0x0000.007F while the default reset value of **GPIOCR** for Port C is 0x0000.00F0.

Table 9-3. GPIO Register Map

Offset	Name	Type	Reset	Description	See page
0x000	GPIODATA	R/W	0x0000.0000	GPIO Data	163
0x400	GPIODIR	R/W	0x0000.0000	GPIO Direction	164
0x404	GPIOIS	R/W	0x0000.0000	GPIO Interrupt Sense	165
0x408	GPIOIBE	R/W	0x0000.0000	GPIO Interrupt Both Edges	166
0x40C	GPIOIEV	R/W	0x0000.0000	GPIO Interrupt Event	167
0x410	GPIOIM	R/W	0x0000.0000	GPIO Interrupt Mask	168
0x414	GPIORIS	RO	0x0000.0000	GPIO Raw Interrupt Status	169
0x418	GPIONIS	RO	0x0000.0000	GPIO Masked Interrupt Status	170
0x41C	GPIOICR	W1C	0x0000.0000	GPIO Interrupt Clear	171

Offset	Name	Type	Reset	Description	See page
0x420	GPIOAFSEL	R/W	-	GPIO Alternate Function Select	172
0x500	GPIODR2R	R/W	0x0000.00FF	GPIO 2-mA Drive Select	174
0x504	GPIODR4R	R/W	0x0000.0000	GPIO 4-mA Drive Select	175
0x508	GPIODR8R	R/W	0x0000.0000	GPIO 8-mA Drive Select	176
0x50C	GPIOODR	R/W	0x0000.0000	GPIO Open Drain Select	177
0x510	GPIOPUR	R/W	-	GPIO Pull-Up Select	178
0x514	GPIOPDR	R/W	0x0000.0000	GPIO Pull-Down Select	179
0x518	GPIOSLR	R/W	0x0000.0000	GPIO Slew Rate Control Select	180
0x51C	GIODEN	R/W	-	GPIO Digital Enable	181
0x520	GPIOLOCK	R/W	0x0000.0001	GPIO Lock	182
0x524	GPIOCR	-	-	GPIO Commit	183
0xFD0	GPIOPeriphID4	RO	0x0000.0000	GPIO Peripheral Identification 4	185
0xFD4	GPIOPeriphID5	RO	0x0000.0000	GPIO Peripheral Identification 5	186
0xFD8	GPIOPeriphID6	RO	0x0000.0000	GPIO Peripheral Identification 6	187
0xFDC	GPIOPeriphID7	RO	0x0000.0000	GPIO Peripheral Identification 7	188
0xFE0	GPIOPeriphID0	RO	0x0000.0061	GPIO Peripheral Identification 0	189
0xFE4	GPIOPeriphID1	RO	0x0000.0000	GPIO Peripheral Identification 1	190
0xFE8	GPIOPeriphID2	RO	0x0000.0018	GPIO Peripheral Identification 2	191
0xFEC	GPIOPeriphID3	RO	0x0000.0001	GPIO Peripheral Identification 3	192
0xFF0	GPIOPCellID0	RO	0x0000.000D	GPIO PrimeCell Identification 0	193
0xFF4	GPIOPCellID1	RO	0x0000.00F0	GPIO PrimeCell Identification 1	194
0xFF8	GPIOPCellID2	RO	0x0000.0005	GPIO PrimeCell Identification 2	195
0xFFC	GPIOPCellID3	RO	0x0000.00B1	GPIO PrimeCell Identification 3	196

9.4 Register Descriptions

The remainder of this section lists and describes the GPIO registers, in numerical order by address offset.

Register 1: GPIO Data (GPIODATA), offset 0x000

The **GPIODATA** register is the data register. In software control mode, values written in the **GPIODATA** register are transferred onto the GPIO port pins if the respective pins have been configured as outputs through the **GPIO Direction (GPIODIR)** register (see page 164).

In order to write to **GPIODATA**, the corresponding bits in the mask, resulting from the address bus bits [9:2], must be High. Otherwise, the bit values remain unchanged by the write.

Similarly, the values read from this register are determined for each bit by the mask bit derived from the address used to access the data register, bits [9:2]. Bits that are 1 in the address mask cause the corresponding bits in **GPIODATA** to be read, and bits that are 0 in the address mask cause the corresponding bits in **GPIODATA** to be read as 0, regardless of their value.

A read from **GPIODATA** returns the last bit value written if the respective pins are configured as outputs, or it returns the value on the corresponding input pin when these are configured as inputs. All bits are cleared by a reset.

GPIO Data (GPIODATA)

GPIO Port A base: 0x4000.4000
 GPIO Port B base: 0x4000.5000
 GPIO Port C base: 0x4000.6000
 GPIO Port D base: 0x4000.7000
 GPIO Port E base: 0x4002.4000
 GPIO Port F base: 0x4002.5000
 GPIO Port G base: 0x4002.6000
 Offset 0x000
 Type R/W, reset 0x0000.0000

	31	30	29	28	27	26	25	24	23	22	21	20	19	18	17	16
	reserved															
Type	RO	RO	RO	RO	RO	RO	RO	RO	RO	RO	RO	RO	RO	RO	RO	RO
Reset	0	0	0	0	0	0	0	0	0	0	0	0	0	0	0	0
	15	14	13	12	11	10	9	8	7	6	5	4	3	2	1	0
	reserved								DATA							
Type	RO	RO	RO	RO	RO	RO	RO	RO	R/W	R/W	R/W	R/W	R/W	R/W	R/W	R/W
Reset	0	0	0	0	0	0	0	0	0	0	0	0	0	0	0	0

Bit/Field	Name	Type	Reset	Description
31:8	reserved	RO	0x00	Software should not rely on the value of a reserved bit. To provide compatibility with future products, the value of a reserved bit should be preserved across a read-modify-write operation.
7:0	DATA	R/W	0x00	GPIO Data

This register is virtually mapped to 256 locations in the address space. To facilitate the reading and writing of data to these registers by independent drivers, the data read from and the data written to the registers are masked by the eight address lines $ipaddr[9:2]$. Reads from this register return its current state. Writes to this register only affect bits that are not masked by $ipaddr[9:2]$ and are configured as outputs. See "Data Register Operation" on page 157 for examples of reads and writes.

Register 2: GPIO Direction (GPIODIR), offset 0x400

The **GPIODIR** register is the data direction register. Bits set to 1 in the **GPIODIR** register configure the corresponding pin to be an output, while bits set to 0 configure the pins to be inputs. All bits are cleared by a reset, meaning all GPIO pins are inputs by default.

GPIO Direction (GPIODIR)

GPIO Port A base: 0x4000.4000
 GPIO Port B base: 0x4000.5000
 GPIO Port C base: 0x4000.6000
 GPIO Port D base: 0x4000.7000
 GPIO Port E base: 0x4002.4000
 GPIO Port F base: 0x4002.5000
 GPIO Port G base: 0x4002.6000
 Offset 0x400
 Type R/W, reset 0x0000.0000

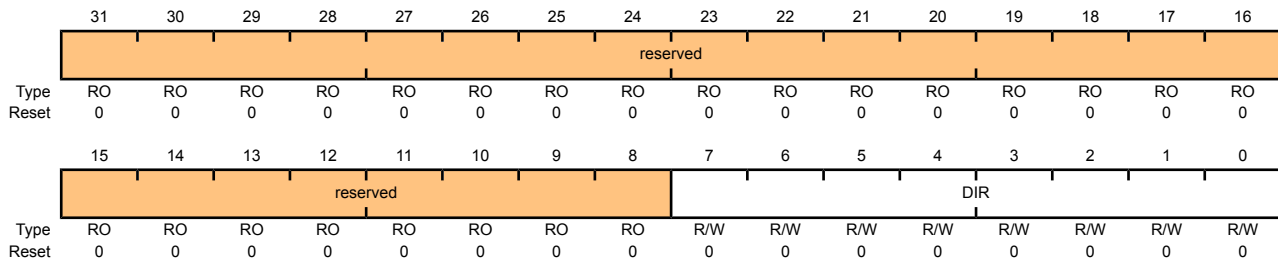

Bit/Field	Name	Type	Reset	Description
31:8	reserved	RO	0x00	Software should not rely on the value of a reserved bit. To provide compatibility with future products, the value of a reserved bit should be preserved across a read-modify-write operation.
7:0	DIR	R/W	0x00	GPIO Data Direction

The **DIR** values are defined as follows:

Value	Description
0	Pins are inputs.
1	Pins are outputs.

Register 3: GPIO Interrupt Sense (GPIOIS), offset 0x404

The **GPIOIS** register is the interrupt sense register. Bits set to 1 in **GPIOIS** configure the corresponding pins to detect levels, while bits set to 0 configure the pins to detect edges. All bits are cleared by a reset.

GPIO Interrupt Sense (GPIOIS)

GPIO Port A base: 0x4000.4000

GPIO Port B base: 0x4000.5000

GPIO Port C base: 0x4000.6000

GPIO Port D base: 0x4000.7000

GPIO Port E base: 0x4002.4000

GPIO Port F base: 0x4002.5000

GPIO Port G base: 0x4002.6000

Offset 0x404

Type R/W, reset 0x0000.0000

	31	30	29	28	27	26	25	24	23	22	21	20	19	18	17	16
	reserved															
Type	RO	RO	RO	RO	RO	RO	RO	RO	RO	RO	RO	RO	RO	RO	RO	RO
Reset	0	0	0	0	0	0	0	0	0	0	0	0	0	0	0	0
	15	14	13	12	11	10	9	8	7	6	5	4	3	2	1	0
	reserved								IS							
Type	RO	RO	RO	RO	RO	RO	RO	RO	R/W	R/W	R/W	R/W	R/W	R/W	R/W	R/W
Reset	0	0	0	0	0	0	0	0	0	0	0	0	0	0	0	0

Bit/Field	Name	Type	Reset	Description
31:8	reserved	RO	0x00	Software should not rely on the value of a reserved bit. To provide compatibility with future products, the value of a reserved bit should be preserved across a read-modify-write operation.
7:0	IS	R/W	0x00	GPIO Interrupt Sense

The **IS** values are defined as follows:

Value Description

- 0 Edge on corresponding pin is detected (edge-sensitive).
- 1 Level on corresponding pin is detected (level-sensitive).

Register 4: GPIO Interrupt Both Edges (GPIOIBE), offset 0x408

The **GPIOIBE** register is the interrupt both-edges register. When the corresponding bit in the **GPIO Interrupt Sense (GPIOIS)** register (see page 165) is set to detect edges, bits set to High in **GPIOIBE** configure the corresponding pin to detect both rising and falling edges, regardless of the corresponding bit in the **GPIO Interrupt Event (GPIOIEV)** register (see page 167). Clearing a bit configures the pin to be controlled by **GPIOIEV**. All bits are cleared by a reset.

GPIO Interrupt Both Edges (GPIOIBE)

GPIO Port A base: 0x4000.4000
 GPIO Port B base: 0x4000.5000
 GPIO Port C base: 0x4000.6000
 GPIO Port D base: 0x4000.7000
 GPIO Port E base: 0x4002.4000
 GPIO Port F base: 0x4002.5000
 GPIO Port G base: 0x4002.6000
 Offset 0x408
 Type R/W, reset 0x0000.0000

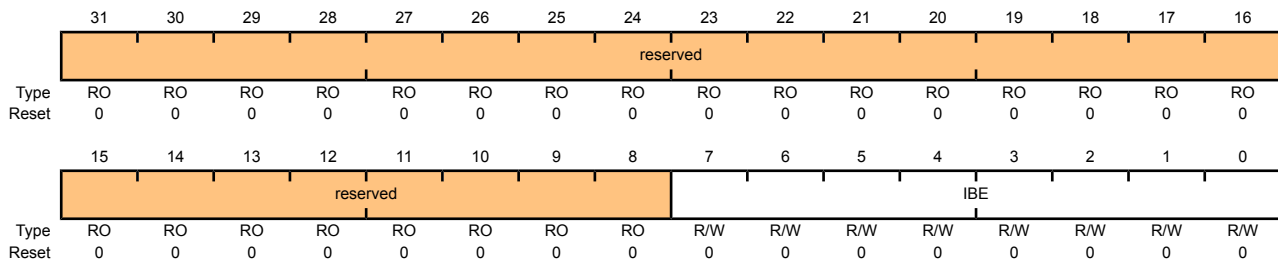

Bit/Field	Name	Type	Reset	Description
31:8	reserved	RO	0x00	Software should not rely on the value of a reserved bit. To provide compatibility with future products, the value of a reserved bit should be preserved across a read-modify-write operation.
7:0	IBE	R/W	0x00	GPIO Interrupt Both Edges

The **IBE** values are defined as follows:

Value	Description
0	Interrupt generation is controlled by the GPIO Interrupt Event (GPIOIEV) register (see page 167).
1	Both edges on the corresponding pin trigger an interrupt.

Note: Single edge is determined by the corresponding bit in **GPIOIEV**.

Register 5: GPIO Interrupt Event (GPIOIEV), offset 0x40C

The **GPIOIEV** register is the interrupt event register. Bits set to High in **GPIOIEV** configure the corresponding pin to detect rising edges or high levels, depending on the corresponding bit value in the **GPIO Interrupt Sense (GPIOIS)** register (see page 165). Clearing a bit configures the pin to detect falling edges or low levels, depending on the corresponding bit value in **GPIOIS**. All bits are cleared by a reset.

GPIO Interrupt Event (GPIOIEV)

GPIO Port A base: 0x4000.4000

GPIO Port B base: 0x4000.5000

GPIO Port C base: 0x4000.6000

GPIO Port D base: 0x4000.7000

GPIO Port E base: 0x4002.4000

GPIO Port F base: 0x4002.5000

GPIO Port G base: 0x4002.6000

Offset 0x40C

Type R/W, reset 0x0000.0000

	31	30	29	28	27	26	25	24	23	22	21	20	19	18	17	16
	reserved															
Type	RO	RO	RO	RO	RO	RO	RO	RO	RO	RO	RO	RO	RO	RO	RO	RO
Reset	0	0	0	0	0	0	0	0	0	0	0	0	0	0	0	0
	15	14	13	12	11	10	9	8	7	6	5	4	3	2	1	0
	reserved								IEV							
Type	RO	RO	RO	RO	RO	RO	RO	RO	R/W	R/W	R/W	R/W	R/W	R/W	R/W	R/W
Reset	0	0	0	0	0	0	0	0	0	0	0	0	0	0	0	0

Bit/Field	Name	Type	Reset	Description
31:8	reserved	RO	0x00	Software should not rely on the value of a reserved bit. To provide compatibility with future products, the value of a reserved bit should be preserved across a read-modify-write operation.

7:0	IEV	R/W	0x00	GPIO Interrupt Event
-----	-----	-----	------	----------------------

The **IEV** values are defined as follows:

Value Description

- | | |
|---|--|
| 0 | Falling edge or Low levels on corresponding pins trigger interrupts. |
| 1 | Rising edge or High levels on corresponding pins trigger interrupts. |

Register 6: GPIO Interrupt Mask (GPIOIM), offset 0x410

The **GPIOIM** register is the interrupt mask register. Bits set to High in **GPIOIM** allow the corresponding pins to trigger their individual interrupts and the combined GPIOINTR line. Clearing a bit disables interrupt triggering on that pin. All bits are cleared by a reset.

GPIO Interrupt Mask (GPIOIM)

GPIO Port A base: 0x4000.4000
 GPIO Port B base: 0x4000.5000
 GPIO Port C base: 0x4000.6000
 GPIO Port D base: 0x4000.7000
 GPIO Port E base: 0x4002.4000
 GPIO Port F base: 0x4002.5000
 GPIO Port G base: 0x4002.6000
 Offset 0x410
 Type R/W, reset 0x0000.0000

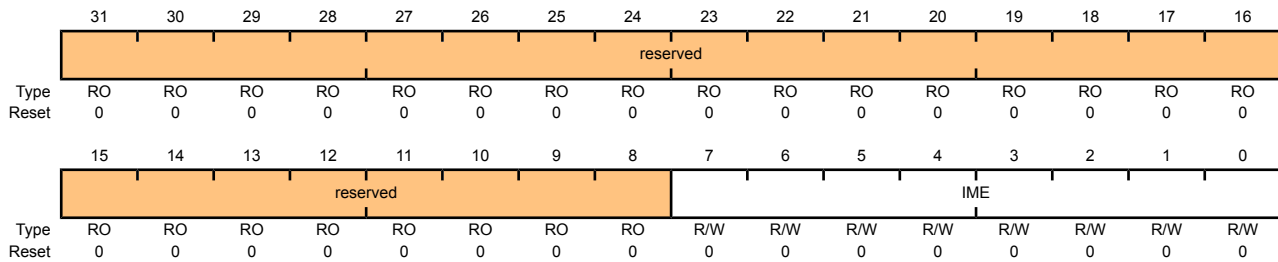

Bit/Field	Name	Type	Reset	Description
31:8	reserved	RO	0x00	Software should not rely on the value of a reserved bit. To provide compatibility with future products, the value of a reserved bit should be preserved across a read-modify-write operation.
7:0	IME	R/W	0x00	GPIO Interrupt Mask Enable

The IME values are defined as follows:

Value	Description
0	Corresponding pin interrupt is masked.
1	Corresponding pin interrupt is not masked.

Register 7: GPIO Raw Interrupt Status (GPIORIS), offset 0x414

The **GPIORIS** register is the raw interrupt status register. Bits read High in **GPIORIS** reflect the status of interrupt trigger conditions detected (raw, prior to masking), indicating that all the requirements have been met, before they are finally allowed to trigger by the **GPIO Interrupt Mask (GPIOIM)** register (see page 168). Bits read as zero indicate that corresponding input pins have not initiated an interrupt. All bits are cleared by a reset.

GPIO Raw Interrupt Status (GPIORIS)

GPIO Port A base: 0x4000.4000
 GPIO Port B base: 0x4000.5000
 GPIO Port C base: 0x4000.6000
 GPIO Port D base: 0x4000.7000
 GPIO Port E base: 0x4002.4000
 GPIO Port F base: 0x4002.5000
 GPIO Port G base: 0x4002.6000
 Offset 0x414
 Type RO, reset 0x0000.0000

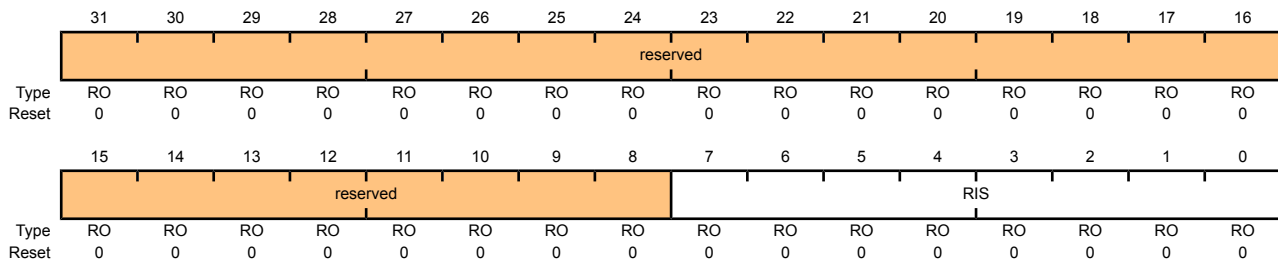

Bit/Field	Name	Type	Reset	Description						
31:8	reserved	RO	0x00	Software should not rely on the value of a reserved bit. To provide compatibility with future products, the value of a reserved bit should be preserved across a read-modify-write operation.						
7:0	RIS	RO	0x00	GPIO Interrupt Raw Status Reflects the status of interrupt trigger condition detection on pins (raw, prior to masking). The RIS values are defined as follows: <table border="0"> <tr> <td>Value</td> <td>Description</td> </tr> <tr> <td>0</td> <td>Corresponding pin interrupt requirements not met.</td> </tr> <tr> <td>1</td> <td>Corresponding pin interrupt has met requirements.</td> </tr> </table>	Value	Description	0	Corresponding pin interrupt requirements not met.	1	Corresponding pin interrupt has met requirements.
Value	Description									
0	Corresponding pin interrupt requirements not met.									
1	Corresponding pin interrupt has met requirements.									

Register 8: GPIO Masked Interrupt Status (GPIOMIS), offset 0x418

The **GPIOMIS** register is the masked interrupt status register. Bits read High in **GPIOMIS** reflect the status of input lines triggering an interrupt. Bits read as Low indicate that either no interrupt has been generated, or the interrupt is masked.

In addition to providing GPIO functionality, **PB4** can also be used as an external trigger for the ADC. If **PB4** is configured as a non-masked interrupt pin (**GPIOIM** is set to 1), not only is an interrupt for PortB generated, but an external trigger signal is sent to the ADC. If the **ADC Event Multiplexer Select (ADCEMUX)** register is configured to use the external trigger, an ADC conversion is initiated.

If no other PortB pins are being used to generate interrupts, the ARM Integrated Nested Vectored Interrupt Controller (NVIC) Interrupt Set Enable (SETNA) register can disable the PortB interrupts and the ADC interrupt can be used to read back the converted data. Otherwise, the PortB interrupt handler needs to ignore and clear interrupts on B4, and wait for the ADC interrupt or the ADC interrupt needs to be disabled in the SETNA register and the PortB interrupt handler polls the ADC registers until the conversion is completed.

GPIOMIS is the state of the interrupt after masking.

GPIO Masked Interrupt Status (GPIOMIS)

GPIO Port A base: 0x4000.4000
 GPIO Port B base: 0x4000.5000
 GPIO Port C base: 0x4000.6000
 GPIO Port D base: 0x4000.7000
 GPIO Port E base: 0x4002.4000
 GPIO Port F base: 0x4002.5000
 GPIO Port G base: 0x4002.6000
 Offset 0x418
 Type RO, reset 0x0000.0000

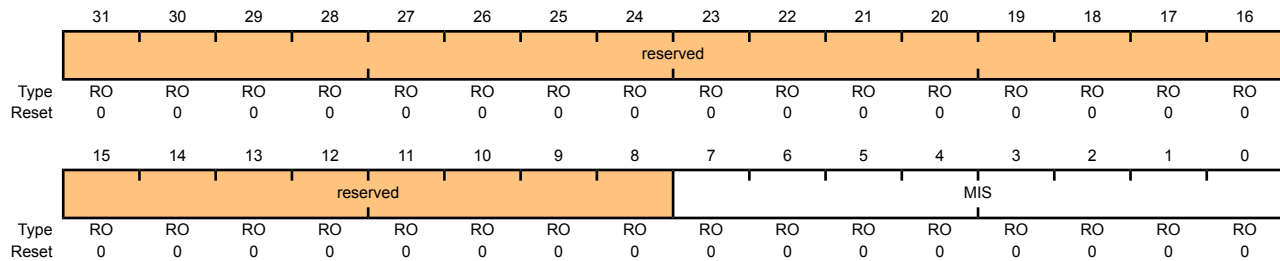

Bit/Field	Name	Type	Reset	Description
31:8	reserved	RO	0x00	Software should not rely on the value of a reserved bit. To provide compatibility with future products, the value of a reserved bit should be preserved across a read-modify-write operation.
7:0	MIS	RO	0x00	GPIO Masked Interrupt Status Masked value of interrupt due to corresponding pin. The MIS values are defined as follows: Value Description 0 Corresponding GPIO line interrupt not active. 1 Corresponding GPIO line asserting interrupt.

Register 9: GPIO Interrupt Clear (GPIOICR), offset 0x41C

The **GPIOICR** register is the interrupt clear register. Writing a 1 to a bit in this register clears the corresponding interrupt edge detection logic register. Writing a 0 has no effect.

GPIO Interrupt Clear (GPIOICR)

GPIO Port A base: 0x4000.4000

GPIO Port B base: 0x4000.5000

GPIO Port C base: 0x4000.6000

GPIO Port D base: 0x4000.7000

GPIO Port E base: 0x4002.4000

GPIO Port F base: 0x4002.5000

GPIO Port G base: 0x4002.6000

Offset 0x41C

Type W1C, reset 0x0000.0000

	31	30	29	28	27	26	25	24	23	22	21	20	19	18	17	16
	reserved															
Type	RO	RO	RO	RO	RO	RO	RO	RO	RO	RO	RO	RO	RO	RO	RO	RO
Reset	0	0	0	0	0	0	0	0	0	0	0	0	0	0	0	0
	15	14	13	12	11	10	9	8	7	6	5	4	3	2	1	0
	reserved								IC							
Type	RO	RO	RO	RO	RO	RO	RO	RO	W1C	W1C	W1C	W1C	W1C	W1C	W1C	W1C
Reset	0	0	0	0	0	0	0	0	0	0	0	0	0	0	0	0

Bit/Field	Name	Type	Reset	Description
31:8	reserved	RO	0x00	Software should not rely on the value of a reserved bit. To provide compatibility with future products, the value of a reserved bit should be preserved across a read-modify-write operation.
7:0	IC	W1C	0x00	GPIO Interrupt Clear

The IC values are defined as follows:

Value	Description
0	Corresponding interrupt is unaffected.
1	Corresponding interrupt is cleared.

Register 10: GPIO Alternate Function Select (GPIOAFSEL), offset 0x420

The **GPIOAFSEL** register is the mode control select register. Writing a 1 to any bit in this register selects the hardware control for the corresponding GPIO line. All bits are cleared by a reset, therefore no GPIO line is set to hardware control by default.

The commit control registers provide a layer of protection against accidental programming of critical hardware peripherals. Writes to protected bits of the **GPIO Alternate Function Select (GPIOAFSEL)** register (see page 172) are not committed to storage unless the **GPIO Lock (GPIOLOCK)** register (see page 182) has been unlocked and the appropriate bits of the **GPIO Commit (GPIOCR)** register (see page 183) have been set to 1.

Important: All GPIO pins are tri-stated by default (**GPIOAFSEL=0**, **GIODEN=0**, **GIOPDR=0**, and **GIOPUR=0**), with the exception of the five JTAG/SWD pins (**PB7** and **PC[3:0]**). The JTAG/SWD pins default to their JTAG/SWD functionality (**GPIOAFSEL=1**, **GIODEN=1** and **GIOPUR=1**). A Power-On-Reset (\overline{POR}) or asserting \overline{RST} puts both groups of pins back to their default state.

Caution – If the JTAG pins are used as GPIOs in a design, PB7 and PC2 cannot have external pull-down resistors connected to both of them at the same time. If both pins are pulled Low during reset, the controller has unpredictable behavior. If this happens, remove one or both of the pull-down resistors, and apply \overline{RST} or power-cycle the part.

In addition, it is possible to create a software sequence that prevents the debugger from connecting to the Stellaris[®] microcontroller. If the program code loaded into flash immediately changes the JTAG pins to their GPIO functionality, the debugger may not have enough time to connect and halt the controller before the JTAG pin functionality switches. This may lock the debugger out of the part. This can be avoided with a software routine that restores JTAG functionality based on an external or software trigger.

GPIO Alternate Function Select (GPIOAFSEL)

GPIO Port A base: 0x4000.4000
 GPIO Port B base: 0x4000.5000
 GPIO Port C base: 0x4000.6000
 GPIO Port D base: 0x4000.7000
 GPIO Port E base: 0x4002.4000
 GPIO Port F base: 0x4002.5000
 GPIO Port G base: 0x4002.6000
 Offset 0x420
 Type R/W, reset -

	31	30	29	28	27	26	25	24	23	22	21	20	19	18	17	16
	reserved															
Type	RO	RO	RO	RO	RO	RO	RO	RO	RO	RO	RO	RO	RO	RO	RO	RO
Reset	0	0	0	0	0	0	0	0	0	0	0	0	0	0	0	0
	15	14	13	12	11	10	9	8	7	6	5	4	3	2	1	0
	reserved								AFSEL							
Type	RO	RO	RO	RO	RO	RO	RO	RO	R/W	R/W	R/W	R/W	R/W	R/W	R/W	R/W
Reset	0	0	0	0	0	0	0	0	-	-	-	-	-	-	-	-

Bit/Field	Name	Type	Reset	Description
31:8	reserved	RO	0x00	Software should not rely on the value of a reserved bit. To provide compatibility with future products, the value of a reserved bit should be preserved across a read-modify-write operation.

Bit/Field	Name	Type	Reset	Description
7:0	AFSEL	R/W	-	GPIO Alternate Function Select The AFSEL values are defined as follows: Value Description 0 Software control of corresponding GPIO line (GPIO mode). 1 Hardware control of corresponding GPIO line (alternate hardware function). Note: The default reset value for the GPIOAFSEL , GPIOPUR , and GPIODEN registers are 0x0000.0000 for all GPIO pins, with the exception of the five JTAG/SWD pins ($PB7$ and $PC[3:0]$). These five pins default to JTAG/SWD functionality. Because of this, the default reset value of these registers for GPIO Port B is 0x0000.0080 while the default reset value for Port C is 0x0000.000F.

Register 11: GPIO 2-mA Drive Select (GPIODR2R), offset 0x500

The **GPIODR2R** register is the 2-mA drive control register. It allows for each GPIO signal in the port to be individually configured without affecting the other pads. When writing a **DRV2** bit for a GPIO signal, the corresponding **DRV4** bit in the **GPIODR4R** register and the **DRV8** bit in the **GPIODR8R** register are automatically cleared by hardware.

GPIO 2-mA Drive Select (GPIODR2R)

GPIO Port A base: 0x4000.4000
 GPIO Port B base: 0x4000.5000
 GPIO Port C base: 0x4000.6000
 GPIO Port D base: 0x4000.7000
 GPIO Port E base: 0x4002.4000
 GPIO Port F base: 0x4002.5000
 GPIO Port G base: 0x4002.6000
 Offset 0x500
 Type R/W, reset 0x0000.00FF

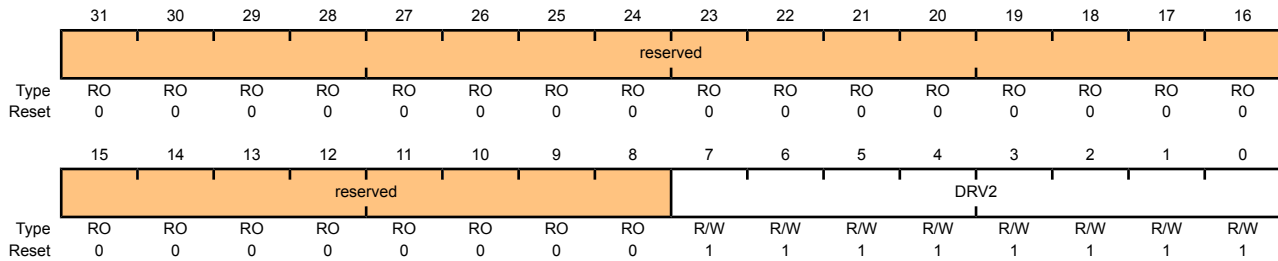

Bit/Field	Name	Type	Reset	Description
31:8	reserved	RO	0x00	Software should not rely on the value of a reserved bit. To provide compatibility with future products, the value of a reserved bit should be preserved across a read-modify-write operation.
7:0	DRV2	R/W	0xFF	Output Pad 2-mA Drive Enable A write of 1 to either GPIODR4[n] or GPIODR8[n] clears the corresponding 2-mA enable bit. The change is effective on the second clock cycle after the write.

Register 12: GPIO 4-mA Drive Select (GPIODR4R), offset 0x504

The **GPIODR4R** register is the 4-mA drive control register. It allows for each GPIO signal in the port to be individually configured without affecting the other pads. When writing the **DRV4** bit for a GPIO signal, the corresponding **DRV2** bit in the **GPIODR2R** register and the **DRV8** bit in the **GPIODR8R** register are automatically cleared by hardware.

GPIO 4-mA Drive Select (GPIODR4R)

GPIO Port A base: 0x4000.4000

GPIO Port B base: 0x4000.5000

GPIO Port C base: 0x4000.6000

GPIO Port D base: 0x4000.7000

GPIO Port E base: 0x4002.4000

GPIO Port F base: 0x4002.5000

GPIO Port G base: 0x4002.6000

Offset 0x504

Type R/W, reset 0x0000.0000

	31	30	29	28	27	26	25	24	23	22	21	20	19	18	17	16
	reserved															
Type	RO	RO	RO	RO	RO	RO	RO	RO	RO	RO	RO	RO	RO	RO	RO	RO
Reset	0	0	0	0	0	0	0	0	0	0	0	0	0	0	0	0
	15	14	13	12	11	10	9	8	7	6	5	4	3	2	1	0
	reserved								DRV4							
Type	RO	RO	RO	RO	RO	RO	RO	RO	R/W	R/W	R/W	R/W	R/W	R/W	R/W	R/W
Reset	0	0	0	0	0	0	0	0	0	0	0	0	0	0	0	0

Bit/Field	Name	Type	Reset	Description
31:8	reserved	RO	0x00	Software should not rely on the value of a reserved bit. To provide compatibility with future products, the value of a reserved bit should be preserved across a read-modify-write operation.
7:0	DRV4	R/W	0x00	Output Pad 4-mA Drive Enable A write of 1 to either GPIODR2[n] or GPIODR8[n] clears the corresponding 4-mA enable bit. The change is effective on the second clock cycle after the write.

Register 13: GPIO 8-mA Drive Select (GPIODR8R), offset 0x508

The **GPIODR8R** register is the 8-mA drive control register. It allows for each GPIO signal in the port to be individually configured without affecting the other pads. When writing the **DRV8** bit for a GPIO signal, the corresponding **DRV2** bit in the **GPIODR2R** register and the **DRV4** bit in the **GPIODR4R** register are automatically cleared by hardware.

GPIO 8-mA Drive Select (GPIODR8R)

GPIO Port A base: 0x4000.4000
 GPIO Port B base: 0x4000.5000
 GPIO Port C base: 0x4000.6000
 GPIO Port D base: 0x4000.7000
 GPIO Port E base: 0x4002.4000
 GPIO Port F base: 0x4002.5000
 GPIO Port G base: 0x4002.6000
 Offset 0x508
 Type R/W, reset 0x0000.0000

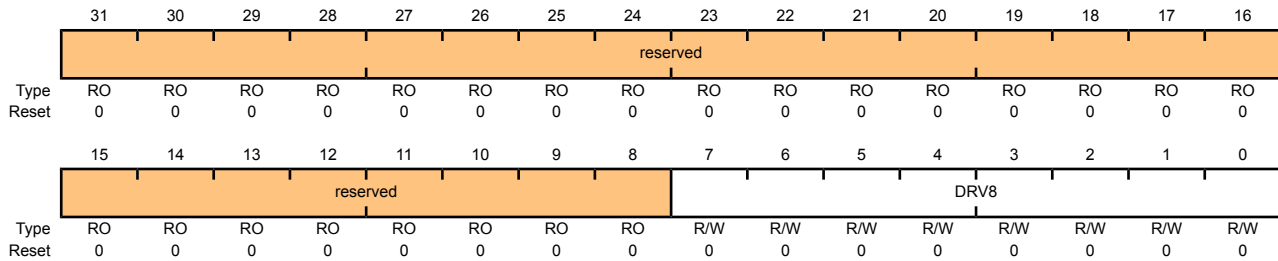

Bit/Field	Name	Type	Reset	Description
31:8	reserved	RO	0x00	Software should not rely on the value of a reserved bit. To provide compatibility with future products, the value of a reserved bit should be preserved across a read-modify-write operation.
7:0	DRV8	R/W	0x00	Output Pad 8-mA Drive Enable A write of 1 to either GPIODR2[n] or GPIODR4[n] clears the corresponding 8-mA enable bit. The change is effective on the second clock cycle after the write.

Register 14: GPIO Open Drain Select (GPIOODR), offset 0x50C

The **GPIOODR** register is the open drain control register. Setting a bit in this register enables the open drain configuration of the corresponding GPIO pad. When open drain mode is enabled, the corresponding bit should also be set in the **GPIO Digital Input Enable (GPIODEN)** register (see page 181). Corresponding bits in the drive strength registers (**GPIODR2R**, **GPIODR4R**, **GPIODR8R**, and **GPIOSLR**) can be set to achieve the desired rise and fall times. The GPIO acts as an open drain input if the corresponding bit in the **GPIODIR** register is set to 0; and as an open drain output when set to 1.

When using the I²C module, the **GPIO Alternate Function Select (GPIOAFSEL)** register bit for PB2 and PB3 should be set to 1 (see examples in “Initialization and Configuration” on page 159).

GPIO Open Drain Select (GPIOODR)

GPIO Port A base: 0x4000.4000

GPIO Port B base: 0x4000.5000

GPIO Port C base: 0x4000.6000

GPIO Port D base: 0x4000.7000

GPIO Port E base: 0x4002.4000

GPIO Port F base: 0x4002.5000

GPIO Port G base: 0x4002.6000

Offset 0x50C

Type R/W, reset 0x0000.0000

	31	30	29	28	27	26	25	24	23	22	21	20	19	18	17	16
	reserved															
Type	RO	RO	RO	RO	RO	RO	RO	RO	RO	RO	RO	RO	RO	RO	RO	RO
Reset	0	0	0	0	0	0	0	0	0	0	0	0	0	0	0	0
	15	14	13	12	11	10	9	8	7	6	5	4	3	2	1	0
	reserved								ODE							
Type	RO	RO	RO	RO	RO	RO	RO	RO	R/W	R/W	R/W	R/W	R/W	R/W	R/W	R/W
Reset	0	0	0	0	0	0	0	0	0	0	0	0	0	0	0	0

Bit/Field	Name	Type	Reset	Description
31:8	reserved	RO	0x00	Software should not rely on the value of a reserved bit. To provide compatibility with future products, the value of a reserved bit should be preserved across a read-modify-write operation.
7:0	ODE	R/W	0x00	Output Pad Open Drain Enable

The ODE values are defined as follows:

Value Description

0 Open drain configuration is disabled.

1 Open drain configuration is enabled.

Register 15: GPIO Pull-Up Select (GPIOPUR), offset 0x510

The **GPIOPUR** register is the pull-up control register. When a bit is set to 1, it enables a weak pull-up resistor on the corresponding GPIO signal. Setting a bit in **GPIOPUR** automatically clears the corresponding bit in the **GPIO Pull-Down Select (GPIOPDR)** register (see page 179).

GPIO Pull-Up Select (GPIOPUR)

GPIO Port A base: 0x4000.4000
 GPIO Port B base: 0x4000.5000
 GPIO Port C base: 0x4000.6000
 GPIO Port D base: 0x4000.7000
 GPIO Port E base: 0x4002.4000
 GPIO Port F base: 0x4002.5000
 GPIO Port G base: 0x4002.6000
 Offset 0x510
 Type R/W, reset -

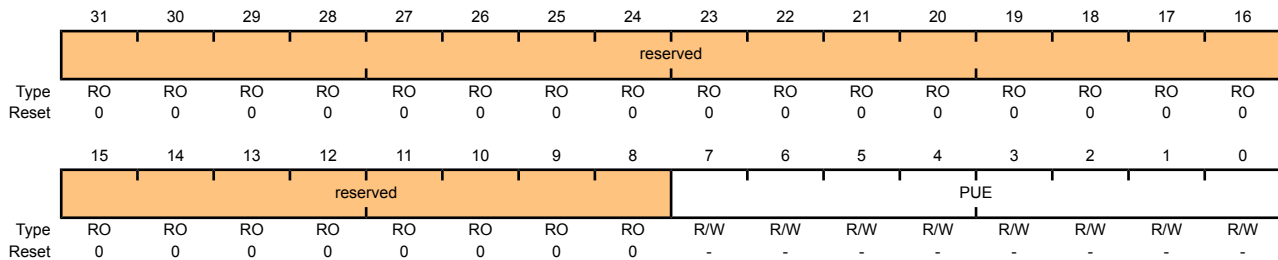

Bit/Field	Name	Type	Reset	Description
31:8	reserved	RO	0x00	Software should not rely on the value of a reserved bit. To provide compatibility with future products, the value of a reserved bit should be preserved across a read-modify-write operation.
7:0	PUE	R/W	-	Pad Weak Pull-Up Enable

A write of 1 to **GPIOPDR[n]** clears the corresponding **GPIOPUR[n]** enables. The change is effective on the second clock cycle after the write.

Note: The default reset value for the **GPIOAFSEL**, **GPIOPUR**, and **GPIODEN** registers are 0x0000.0000 for all GPIO pins, with the exception of the five JTAG/SWD pins (**PB7** and **PC[3:0]**). These five pins default to JTAG/SWD functionality. Because of this, the default reset value of these registers for GPIO Port B is 0x0000.0080 while the default reset value for Port C is 0x0000.000F.

Register 16: GPIO Pull-Down Select (GPIOPDR), offset 0x514

The **GPIOPDR** register is the pull-down control register. When a bit is set to 1, it enables a weak pull-down resistor on the corresponding GPIO signal. Setting a bit in **GPIOPDR** automatically clears the corresponding bit in the **GPIO Pull-Up Select (GPIOPUR)** register (see page 178).

GPIO Pull-Down Select (GPIOPDR)

GPIO Port A base: 0x4000.4000

GPIO Port B base: 0x4000.5000

GPIO Port C base: 0x4000.6000

GPIO Port D base: 0x4000.7000

GPIO Port E base: 0x4002.4000

GPIO Port F base: 0x4002.5000

GPIO Port G base: 0x4002.6000

Offset 0x514

Type R/W, reset 0x0000.0000

	31	30	29	28	27	26	25	24	23	22	21	20	19	18	17	16
	reserved															
Type	RO	RO	RO	RO	RO	RO	RO	RO	RO	RO	RO	RO	RO	RO	RO	RO
Reset	0	0	0	0	0	0	0	0	0	0	0	0	0	0	0	0
	15	14	13	12	11	10	9	8	7	6	5	4	3	2	1	0
	reserved								PDE							
Type	RO	RO	RO	RO	RO	RO	RO	RO	R/W	R/W	R/W	R/W	R/W	R/W	R/W	R/W
Reset	0	0	0	0	0	0	0	0	0	0	0	0	0	0	0	0

Bit/Field	Name	Type	Reset	Description
31:8	reserved	RO	0x00	Software should not rely on the value of a reserved bit. To provide compatibility with future products, the value of a reserved bit should be preserved across a read-modify-write operation.
7:0	PDE	R/W	0x00	Pad Weak Pull-Down Enable A write of 1 to GPIOPUR[n] clears the corresponding GPIOPDR[n] enables. The change is effective on the second clock cycle after the write.

Register 17: GPIO Slew Rate Control Select (GPIOSLR), offset 0x518

The **GPIOSLR** register is the slew rate control register. Slew rate control is only available when using the 8-mA drive strength option via the **GPIO 8-mA Drive Select (GPIODR8R)** register (see page 176).

GPIO Slew Rate Control Select (GPIOSLR)

GPIO Port A base: 0x4000.4000
 GPIO Port B base: 0x4000.5000
 GPIO Port C base: 0x4000.6000
 GPIO Port D base: 0x4000.7000
 GPIO Port E base: 0x4002.4000
 GPIO Port F base: 0x4002.5000
 GPIO Port G base: 0x4002.6000
 Offset 0x518
 Type R/W, reset 0x0000.0000

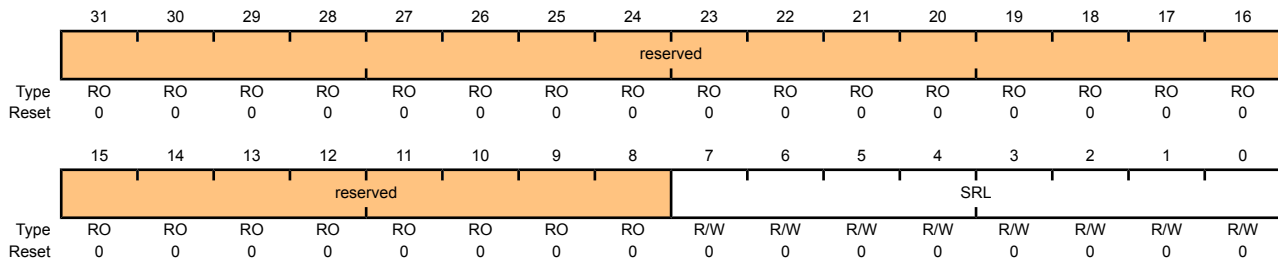

Bit/Field	Name	Type	Reset	Description
31:8	reserved	RO	0x00	Software should not rely on the value of a reserved bit. To provide compatibility with future products, the value of a reserved bit should be preserved across a read-modify-write operation.
7:0	SRL	R/W	0x00	Slew Rate Limit Enable (8-mA drive only)

The **SRL** values are defined as follows:

Value	Description
0	Slew rate control disabled.
1	Slew rate control enabled.

Register 18: GPIO Digital Enable (GPIODEN), offset 0x51C

The **GPIODEN** register is the digital enable register. By default, with the exception of the GPIO signals used for JTAG/SWD function, all other GPIO signals are configured out of reset to be undriven (tristate). Their digital function is disabled; they do not drive a logic value on the pin and they do not allow the pin voltage into the GPIO receiver. To use the pin in a digital function (either GPIO or alternate function), the corresponding **GPIODEN** bit must be set.

GPIO Digital Enable (GPIODEN)

GPIO Port A base: 0x4000.4000
 GPIO Port B base: 0x4000.5000
 GPIO Port C base: 0x4000.6000
 GPIO Port D base: 0x4000.7000
 GPIO Port E base: 0x4002.4000
 GPIO Port F base: 0x4002.5000
 GPIO Port G base: 0x4002.6000
 Offset 0x51C
 Type R/W, reset -

	31	30	29	28	27	26	25	24	23	22	21	20	19	18	17	16
	reserved															
Type	RO	RO	RO	RO	RO	RO	RO	RO	RO	RO	RO	RO	RO	RO	RO	RO
Reset	0	0	0	0	0	0	0	0	0	0	0	0	0	0	0	0
	15	14	13	12	11	10	9	8	7	6	5	4	3	2	1	0
	reserved								DEN							
Type	RO	RO	RO	RO	RO	RO	RO	RO	R/W	R/W	R/W	R/W	R/W	R/W	R/W	R/W
Reset	0	0	0	0	0	0	0	0	-	-	-	-	-	-	-	-

Bit/Field	Name	Type	Reset	Description
31:8	reserved	RO	0x00	Software should not rely on the value of a reserved bit. To provide compatibility with future products, the value of a reserved bit should be preserved across a read-modify-write operation.
7:0	DEN	R/W	-	Digital Enable

The **DEN** values are defined as follows:

Value	Description
0	Digital functions disabled.
1	Digital functions enabled.

Note: The default reset value for the **GPIODEN**, **GPIOPUR**, and **GPIODEN** registers are 0x0000.0000 for all GPIO pins, with the exception of the five JTAG/SWD pins (**PB7** and **PC[3:0]**). These five pins default to JTAG/SWD functionality. Because of this, the default reset value of these registers for GPIO Port B is 0x0000.0080 while the default reset value for Port C is 0x0000.000F.

Register 19: GPIO Lock (GPIOLOCK), offset 0x520

The **GPIOLOCK** register enables write access to the **GPIOCR** register (see page 183). Writing 0x1ACCE551 to the **GPIOLOCK** register will unlock the **GPIOCR** register. Writing any other value to the **GPIOLOCK** register re-enables the locked state. Reading the **GPIOLOCK** register returns the lock status rather than the 32-bit value that was previously written. Therefore, when write accesses are disabled, or locked, reading the **GPIOLOCK** register returns 0x00000001. When write accesses are enabled, or unlocked, reading the **GPIOLOCK** register returns 0x00000000.

GPIO Lock (GPIOLOCK)

GPIO Port A base: 0x4000.4000
 GPIO Port B base: 0x4000.5000
 GPIO Port C base: 0x4000.6000
 GPIO Port D base: 0x4000.7000
 GPIO Port E base: 0x4002.4000
 GPIO Port F base: 0x4002.5000
 GPIO Port G base: 0x4002.6000
 Offset 0x520
 Type R/W, reset 0x0000.0001

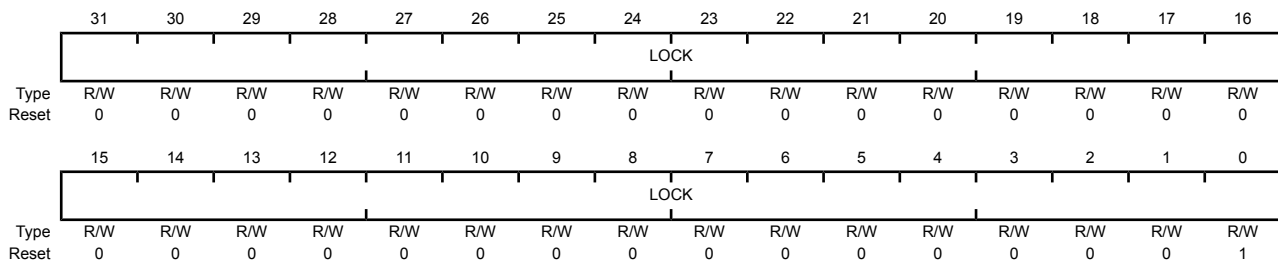

Bit/Field	Name	Type	Reset	Description
31:0	LOCK	R/W	0x0000.0001	GPIO Lock

A write of the value 0x1ACCE551 unlocks the **GPIO Commit (GPIOCR)** register for write access. A write of any other value reapplies the lock, preventing any register updates. A read of this register returns the following values:

Value	Description
0x0000.0001	locked
0x0000.0000	unlocked

Register 20: GPIO Commit (GPIOCR), offset 0x524

The **GPIOCR** register is the commit register. The value of the **GPIOCR** register determines which bits of the **GPIOAFSEL** register will be committed when a write to the **GPIOAFSEL** register is performed. If a bit in the **GPIOCR** register is a zero, the data being written to the corresponding bit in the **GPIOAFSEL** register will not be committed and will retain its previous value. If a bit in the **GPIOCR** register is a one, the data being written to the corresponding bit of the **GPIOAFSEL** register will be committed to the register and will reflect the new value.

The contents of the **GPIOCR** register can only be modified if the **GPIOLOCK** register is unlocked. Writes to the **GPIOCR** register will be ignored if the **GPIOLOCK** register is locked.

Important: This register is designed to prevent accidental programming of the **GPIOAFSEL** registers that control connectivity to the JTAG/SWD debug hardware. By initializing the bits of the **GPIOCR** register to 0 for PB7 and PC[3:0], the JTAG/SWD debug port can only be converted to GPIOs through a deliberate set of writes to the **GPIOLOCK**, **GPIOCR**, and **GPIOAFSEL** registers.

Because this protection is currently only implemented on the JTAG/SWD pins on PB7 and PC[3:0], all of the other bits in the **GPIOCR** registers cannot be written with 0x0. These bits are hardwired to 0x1, ensuring that it is always possible to commit new values to the **GPIOAFSEL** register bits of these other pins.

GPIO Commit (GPIOCR)

GPIO Port A base: 0x4000.4000
 GPIO Port B base: 0x4000.5000
 GPIO Port C base: 0x4000.6000
 GPIO Port D base: 0x4000.7000
 GPIO Port E base: 0x4002.4000
 GPIO Port F base: 0x4002.5000
 GPIO Port G base: 0x4002.6000
 Offset 0x524
 Type -, reset -

	31	30	29	28	27	26	25	24	23	22	21	20	19	18	17	16
	reserved															
Type	RO	RO	RO	RO	RO	RO	RO	RO	RO	RO	RO	RO	RO	RO	RO	RO
Reset	0	0	0	0	0	0	0	0	0	0	0	0	0	0	0	0
	15	14	13	12	11	10	9	8	7	6	5	4	3	2	1	0
	reserved								CR							
Type	RO	RO	RO	RO	RO	RO	RO	RO	-	-	-	-	-	-	-	-
Reset	0	0	0	0	0	0	0	0	-	-	-	-	-	-	-	-

Bit/Field	Name	Type	Reset	Description
31:8	reserved	RO	0x00	Software should not rely on the value of a reserved bit. To provide compatibility with future products, the value of a reserved bit should be preserved across a read-modify-write operation.

Bit/Field	Name	Type	Reset	Description
7:0	CR	-	-	GPIO Commit

On a bit-wise basis, any bit set allows the corresponding `GPIOAFSEL` bit to be set to its alternate function.

Note: The default register type for the **GPIOCR** register is RO for all GPIO pins, with the exception of the five JTAG/SWD pins (`PB7` and `PC[3:0]`). These five pins are currently the only GPIOs that are protected by the **GPIOCR** register. Because of this, the register type for GPIO Port B7 and GPIO Port C[3:0] is R/W.

The default reset value for the **GPIOCR** register is 0x0000.00FF for all GPIO pins, with the exception of the five JTAG/SWD pins (`PB7` and `PC[3:0]`). To ensure that the JTAG port is not accidentally programmed as a GPIO, these five pins default to non-commitable. Because of this, the default reset value of **GPIOCR** for GPIO Port B is 0x0000.007F while the default reset value of **GPIOCR** for Port C is 0x0000.00F0.

Register 21: GPIO Peripheral Identification 4 (GPIOPeriphID4), offset 0xFD0

The **GPIOPeriphID4**, **GPIOPeriphID5**, **GPIOPeriphID6**, and **GPIOPeriphID7** registers can conceptually be treated as one 32-bit register; each register contains eight bits of the 32-bit register, used by software to identify the peripheral.

GPIO Peripheral Identification 4 (GPIOPeriphID4)

GPIO Port A base: 0x4000.4000

GPIO Port B base: 0x4000.5000

GPIO Port C base: 0x4000.6000

GPIO Port D base: 0x4000.7000

GPIO Port E base: 0x4002.4000

GPIO Port F base: 0x4002.5000

GPIO Port G base: 0x4002.6000

Offset 0xFD0

Type RO, reset 0x0000.0000

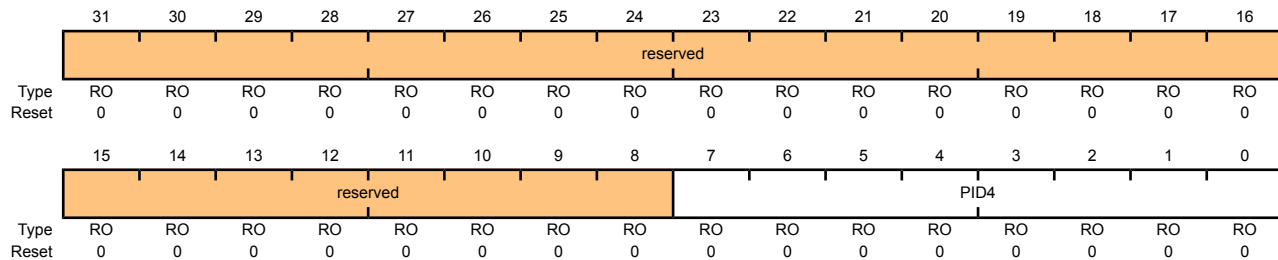

Bit/Field	Name	Type	Reset	Description
31:8	reserved	RO	0x00	Software should not rely on the value of a reserved bit. To provide compatibility with future products, the value of a reserved bit should be preserved across a read-modify-write operation.
7:0	PID4	RO	0x00	GPIO Peripheral ID Register[7:0]

Register 22: GPIO Peripheral Identification 5 (GPIOPeriphID5), offset 0xFD4

The **GPIOPeriphID4**, **GPIOPeriphID5**, **GPIOPeriphID6**, and **GPIOPeriphID7** registers can conceptually be treated as one 32-bit register; each register contains eight bits of the 32-bit register, used by software to identify the peripheral.

GPIO Peripheral Identification 5 (GPIOPeriphID5)

GPIO Port A base: 0x4000.4000
 GPIO Port B base: 0x4000.5000
 GPIO Port C base: 0x4000.6000
 GPIO Port D base: 0x4000.7000
 GPIO Port E base: 0x4002.4000
 GPIO Port F base: 0x4002.5000
 GPIO Port G base: 0x4002.6000
 Offset 0xFD4
 Type RO, reset 0x0000.0000

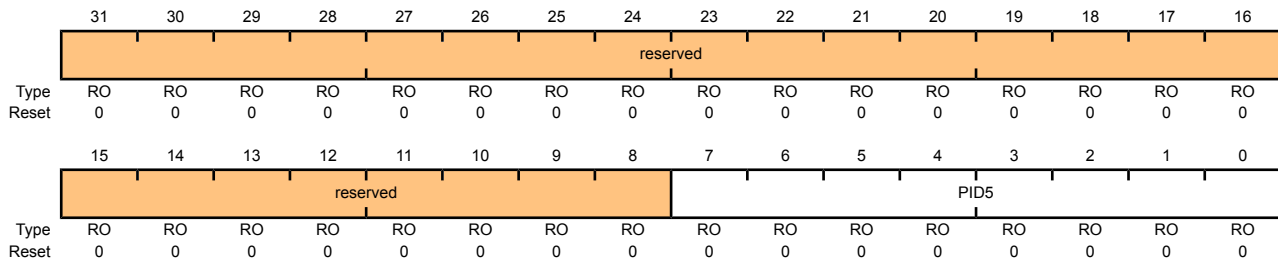

Bit/Field	Name	Type	Reset	Description
31:8	reserved	RO	0x00	Software should not rely on the value of a reserved bit. To provide compatibility with future products, the value of a reserved bit should be preserved across a read-modify-write operation.
7:0	PID5	RO	0x00	GPIO Peripheral ID Register[15:8]

Register 23: GPIO Peripheral Identification 6 (GPIOPeriphID6), offset 0xFD8

The **GPIOPeriphID4**, **GPIOPeriphID5**, **GPIOPeriphID6**, and **GPIOPeriphID7** registers can conceptually be treated as one 32-bit register; each register contains eight bits of the 32-bit register, used by software to identify the peripheral.

GPIO Peripheral Identification 6 (GPIOPeriphID6)

GPIO Port A base: 0x4000.4000
 GPIO Port B base: 0x4000.5000
 GPIO Port C base: 0x4000.6000
 GPIO Port D base: 0x4000.7000
 GPIO Port E base: 0x4002.4000
 GPIO Port F base: 0x4002.5000
 GPIO Port G base: 0x4002.6000
 Offset 0xFD8
 Type RO, reset 0x0000.0000

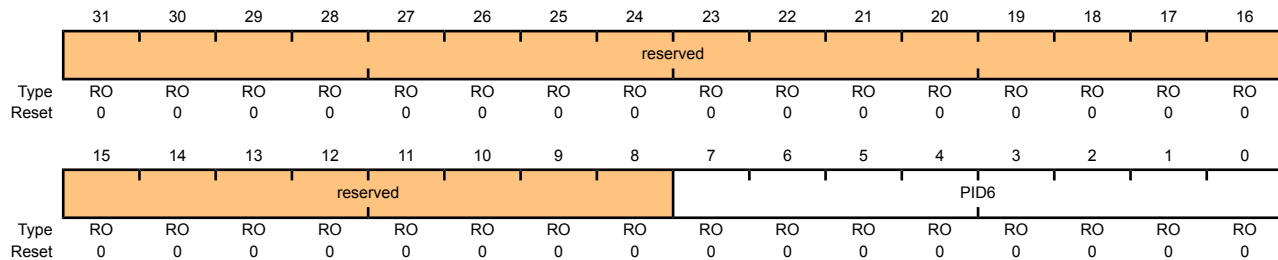

Bit/Field	Name	Type	Reset	Description
31:8	reserved	RO	0x00	Software should not rely on the value of a reserved bit. To provide compatibility with future products, the value of a reserved bit should be preserved across a read-modify-write operation.
7:0	PID6	RO	0x00	GPIO Peripheral ID Register[23:16]

Register 24: GPIO Peripheral Identification 7 (GPIOPeriphID7), offset 0xFDC

The **GPIOPeriphID4**, **GPIOPeriphID5**, **GPIOPeriphID6**, and **GPIOPeriphID7** registers can conceptually be treated as one 32-bit register; each register contains eight bits of the 32-bit register, used by software to identify the peripheral.

GPIO Peripheral Identification 7 (GPIOPeriphID7)

GPIO Port A base: 0x4000.4000
 GPIO Port B base: 0x4000.5000
 GPIO Port C base: 0x4000.6000
 GPIO Port D base: 0x4000.7000
 GPIO Port E base: 0x4002.4000
 GPIO Port F base: 0x4002.5000
 GPIO Port G base: 0x4002.6000
 Offset 0xFDC
 Type RO, reset 0x0000.0000

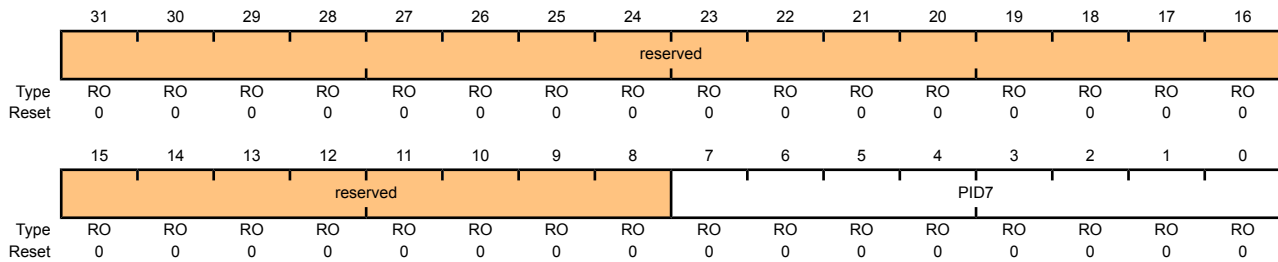

Bit/Field	Name	Type	Reset	Description
31:8	reserved	RO	0x00	Software should not rely on the value of a reserved bit. To provide compatibility with future products, the value of a reserved bit should be preserved across a read-modify-write operation.
7:0	PID7	RO	0x00	GPIO Peripheral ID Register[31:24]

Register 25: GPIO Peripheral Identification 0 (GPIOPeriphID0), offset 0xFE0

The **GPIOPeriphID0**, **GPIOPeriphID1**, **GPIOPeriphID2**, and **GPIOPeriphID3** registers can conceptually be treated as one 32-bit register; each register contains eight bits of the 32-bit register, used by software to identify the peripheral.

GPIO Peripheral Identification 0 (GPIOPeriphID0)

GPIO Port A base: 0x4000.4000

GPIO Port B base: 0x4000.5000

GPIO Port C base: 0x4000.6000

GPIO Port D base: 0x4000.7000

GPIO Port E base: 0x4002.4000

GPIO Port F base: 0x4002.5000

GPIO Port G base: 0x4002.6000

Offset 0xFE0

Type RO, reset 0x0000.0061

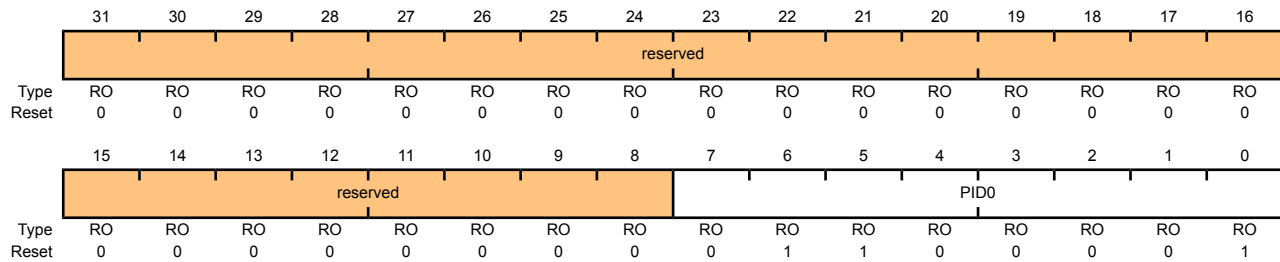

Bit/Field	Name	Type	Reset	Description
31:8	reserved	RO	0x00	Software should not rely on the value of a reserved bit. To provide compatibility with future products, the value of a reserved bit should be preserved across a read-modify-write operation.
7:0	PID0	RO	0x61	GPIO Peripheral ID Register[7:0] Can be used by software to identify the presence of this peripheral.

Register 26: GPIO Peripheral Identification 1 (GPIOPeriphID1), offset 0xFE4

The **GPIOPeriphID0**, **GPIOPeriphID1**, **GPIOPeriphID2**, and **GPIOPeriphID3** registers can conceptually be treated as one 32-bit register; each register contains eight bits of the 32-bit register, used by software to identify the peripheral.

GPIO Peripheral Identification 1 (GPIOPeriphID1)

GPIO Port A base: 0x4000.4000
 GPIO Port B base: 0x4000.5000
 GPIO Port C base: 0x4000.6000
 GPIO Port D base: 0x4000.7000
 GPIO Port E base: 0x4002.4000
 GPIO Port F base: 0x4002.5000
 GPIO Port G base: 0x4002.6000
 Offset 0xFE4
 Type RO, reset 0x0000.0000

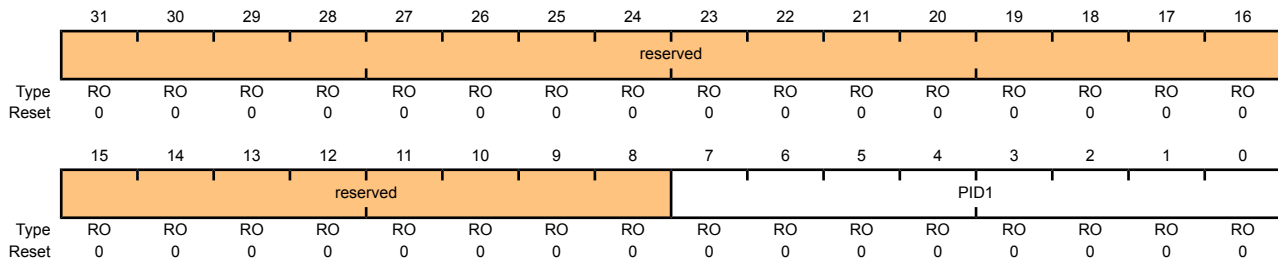

Bit/Field	Name	Type	Reset	Description
31:8	reserved	RO	0x00	Software should not rely on the value of a reserved bit. To provide compatibility with future products, the value of a reserved bit should be preserved across a read-modify-write operation.
7:0	PID1	RO	0x00	GPIO Peripheral ID Register[15:8] Can be used by software to identify the presence of this peripheral.

Register 27: GPIO Peripheral Identification 2 (GPIOPeriphID2), offset 0xFE8

The **GPIOPeriphID0**, **GPIOPeriphID1**, **GPIOPeriphID2**, and **GPIOPeriphID3** registers can conceptually be treated as one 32-bit register; each register contains eight bits of the 32-bit register, used by software to identify the peripheral.

GPIO Peripheral Identification 2 (GPIOPeriphID2)

GPIO Port A base: 0x4000.4000

GPIO Port B base: 0x4000.5000

GPIO Port C base: 0x4000.6000

GPIO Port D base: 0x4000.7000

GPIO Port E base: 0x4002.4000

GPIO Port F base: 0x4002.5000

GPIO Port G base: 0x4002.6000

Offset 0xFE8

Type RO, reset 0x0000.0018

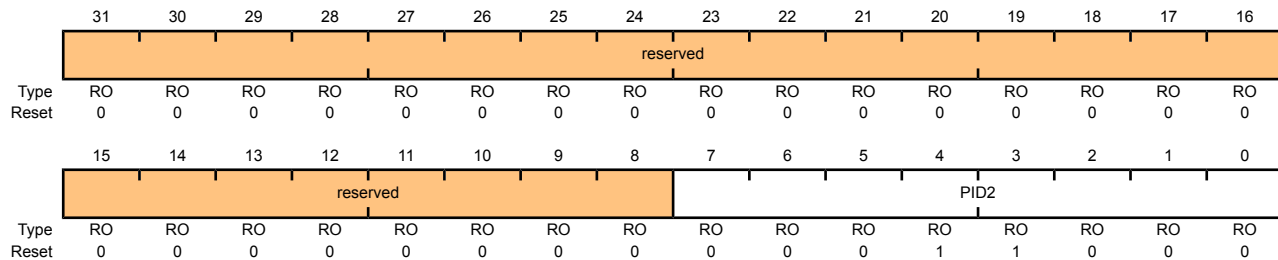

Bit/Field	Name	Type	Reset	Description
31:8	reserved	RO	0x00	Software should not rely on the value of a reserved bit. To provide compatibility with future products, the value of a reserved bit should be preserved across a read-modify-write operation.
7:0	PID2	RO	0x18	GPIO Peripheral ID Register[23:16] Can be used by software to identify the presence of this peripheral.

Register 28: GPIO Peripheral Identification 3 (GPIOPeriphID3), offset 0xFEC

The **GPIOPeriphID0**, **GPIOPeriphID1**, **GPIOPeriphID2**, and **GPIOPeriphID3** registers can conceptually be treated as one 32-bit register; each register contains eight bits of the 32-bit register, used by software to identify the peripheral.

GPIO Peripheral Identification 3 (GPIOPeriphID3)

GPIO Port A base: 0x4000.4000
 GPIO Port B base: 0x4000.5000
 GPIO Port C base: 0x4000.6000
 GPIO Port D base: 0x4000.7000
 GPIO Port E base: 0x4002.4000
 GPIO Port F base: 0x4002.5000
 GPIO Port G base: 0x4002.6000
 Offset 0xFEC
 Type RO, reset 0x0000.0001

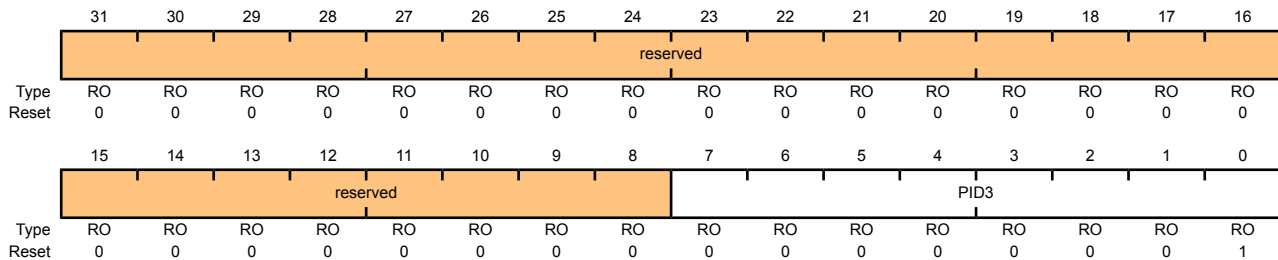

Bit/Field	Name	Type	Reset	Description
31:8	reserved	RO	0x00	Software should not rely on the value of a reserved bit. To provide compatibility with future products, the value of a reserved bit should be preserved across a read-modify-write operation.
7:0	PID3	RO	0x01	GPIO Peripheral ID Register[31:24] Can be used by software to identify the presence of this peripheral.

Register 29: GPIO PrimeCell Identification 0 (GPIOCellID0), offset 0xFF0

The **GPIOCellID0**, **GPIOCellID1**, **GPIOCellID2**, and **GPIOCellID3** registers are four 8-bit wide registers, that can conceptually be treated as one 32-bit register. The register is used as a standard cross-peripheral identification system.

GPIO PrimeCell Identification 0 (GPIOCellID0)

GPIO Port A base: 0x4000.4000
 GPIO Port B base: 0x4000.5000
 GPIO Port C base: 0x4000.6000
 GPIO Port D base: 0x4000.7000
 GPIO Port E base: 0x4002.4000
 GPIO Port F base: 0x4002.5000
 GPIO Port G base: 0x4002.6000
 Offset 0xFF0
 Type RO, reset 0x0000.000D

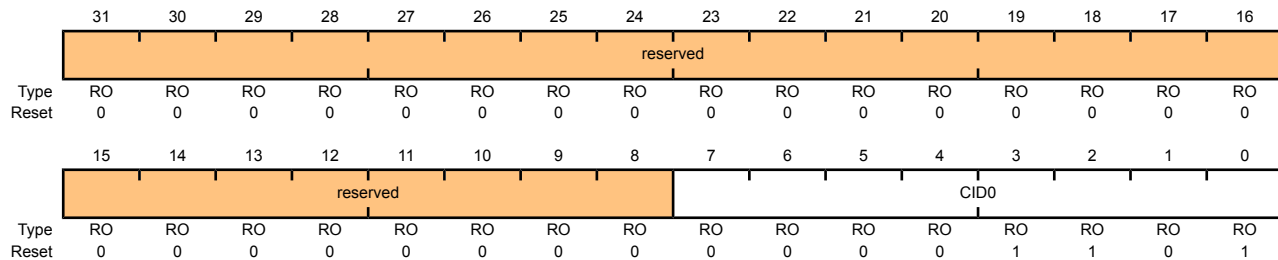

Bit/Field	Name	Type	Reset	Description
31:8	reserved	RO	0x00	Software should not rely on the value of a reserved bit. To provide compatibility with future products, the value of a reserved bit should be preserved across a read-modify-write operation.
7:0	CID0	RO	0x0D	GPIO PrimeCell ID Register[7:0] Provides software a standard cross-peripheral identification system.

Register 30: GPIO PrimeCell Identification 1 (GPIOCellID1), offset 0xFF4

The **GPIOCellID0**, **GPIOCellID1**, **GPIOCellID2**, and **GPIOCellID3** registers are four 8-bit wide registers, that can conceptually be treated as one 32-bit register. The register is used as a standard cross-peripheral identification system.

GPIO PrimeCell Identification 1 (GPIOCellID1)

GPIO Port A base: 0x4000.4000
 GPIO Port B base: 0x4000.5000
 GPIO Port C base: 0x4000.6000
 GPIO Port D base: 0x4000.7000
 GPIO Port E base: 0x4002.4000
 GPIO Port F base: 0x4002.5000
 GPIO Port G base: 0x4002.6000
 Offset 0xFF4
 Type RO, reset 0x0000.00F0

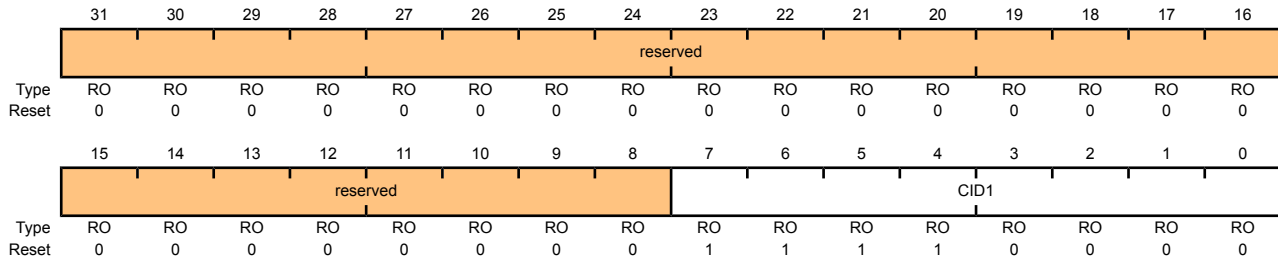

Bit/Field	Name	Type	Reset	Description
31:8	reserved	RO	0x00	Software should not rely on the value of a reserved bit. To provide compatibility with future products, the value of a reserved bit should be preserved across a read-modify-write operation.
7:0	CID1	RO	0xF0	GPIO PrimeCell ID Register[15:8] Provides software a standard cross-peripheral identification system.

Register 31: GPIO PrimeCell Identification 2 (GPIOCellID2), offset 0xFF8

The **GPIOCellID0**, **GPIOCellID1**, **GPIOCellID2**, and **GPIOCellID3** registers are four 8-bit wide registers, that can conceptually be treated as one 32-bit register. The register is used as a standard cross-peripheral identification system.

GPIO PrimeCell Identification 2 (GPIOCellID2)

GPIO Port A base: 0x4000.4000
 GPIO Port B base: 0x4000.5000
 GPIO Port C base: 0x4000.6000
 GPIO Port D base: 0x4000.7000
 GPIO Port E base: 0x4002.4000
 GPIO Port F base: 0x4002.5000
 GPIO Port G base: 0x4002.6000
 Offset 0xFF8
 Type RO, reset 0x0000.0005

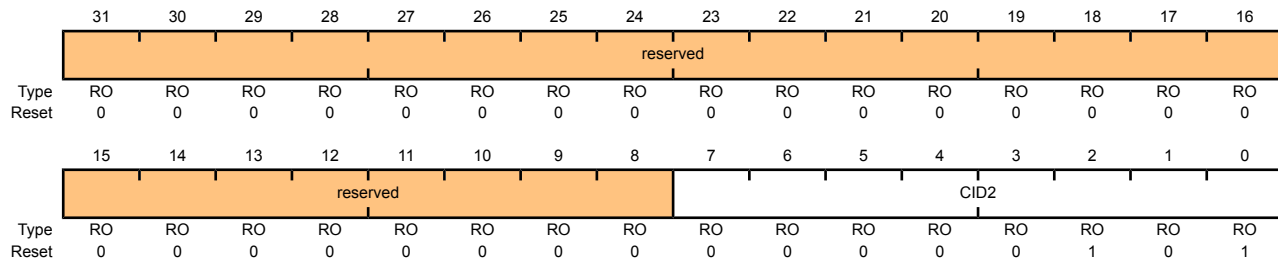

Bit/Field	Name	Type	Reset	Description
31:8	reserved	RO	0x00	Software should not rely on the value of a reserved bit. To provide compatibility with future products, the value of a reserved bit should be preserved across a read-modify-write operation.
7:0	CID2	RO	0x05	GPIO PrimeCell ID Register[23:16] Provides software a standard cross-peripheral identification system.

Register 32: GPIO PrimeCell Identification 3 (GPIOCellID3), offset 0xFFC

The **GPIOCellID0**, **GPIOCellID1**, **GPIOCellID2**, and **GPIOCellID3** registers are four 8-bit wide registers, that can conceptually be treated as one 32-bit register. The register is used as a standard cross-peripheral identification system.

GPIO PrimeCell Identification 3 (GPIOCellID3)

GPIO Port A base: 0x4000.4000
 GPIO Port B base: 0x4000.5000
 GPIO Port C base: 0x4000.6000
 GPIO Port D base: 0x4000.7000
 GPIO Port E base: 0x4002.4000
 GPIO Port F base: 0x4002.5000
 GPIO Port G base: 0x4002.6000
 Offset 0xFFC
 Type RO, reset 0x0000.00B1

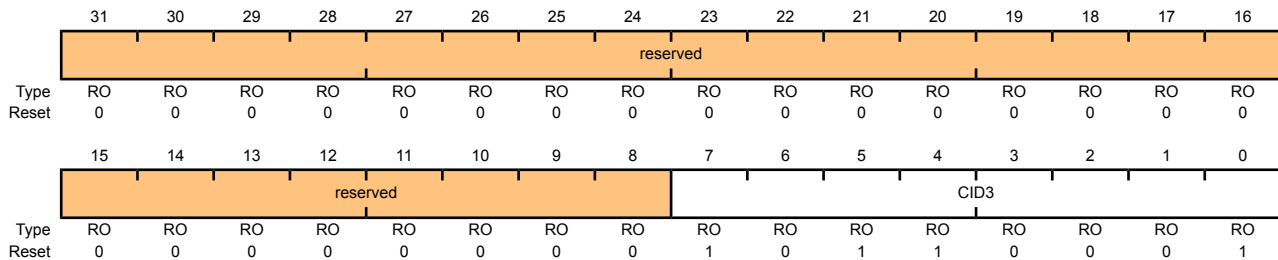

Bit/Field	Name	Type	Reset	Description
31:8	reserved	RO	0x00	Software should not rely on the value of a reserved bit. To provide compatibility with future products, the value of a reserved bit should be preserved across a read-modify-write operation.
7:0	CID3	RO	0xB1	GPIO PrimeCell ID Register[31:24] Provides software a standard cross-peripheral identification system.

10 General-Purpose Timers

Programmable timers can be used to count or time external events that drive the Timer input pins. The Stellaris[®] General-Purpose Timer Module (GPTM) contains four GPTM blocks (Timer0, Timer1, Timer 2, and Timer 3). Each GPTM block provides two 16-bit timers/counters (referred to as TimerA and TimerB) that can be configured to operate independently as timers or event counters, or configured to operate as one 32-bit timer or one 32-bit Real-Time Clock (RTC). Timers can also be used to trigger analog-to-digital (ADC) conversions. The trigger signals from all of the general-purpose timers are ORed together before reaching the ADC module, so only one timer should be used to trigger ADC events.

Note: Timer2 is an internal timer and can only be used to generate internal interrupts or trigger ADC events.

The General-Purpose Timer Module is one timing resource available on the Stellaris[®] microcontrollers. Other timer resources include the System Timer (SysTick) (see “System Timer (SysTick)” on page 37) and the PWM timer in the PWM module (see “PWM Timer” on page 445).

The following modes are supported:

- 32-bit Timer modes
 - Programmable one-shot timer
 - Programmable periodic timer
 - Real-Time Clock using 32.768-KHz input clock
 - Software-controlled event stalling (excluding RTC mode)
- 16-bit Timer modes
 - General-purpose timer function with an 8-bit prescaler (for one-shot and periodic modes only)
 - Programmable one-shot timer
 - Programmable periodic timer
 - Software-controlled event stalling
- 16-bit Input Capture modes
 - Input edge count capture
 - Input edge time capture
- 16-bit PWM mode
 - Simple PWM mode with software-programmable output inversion of the PWM signal

10.1 Block Diagram

Note: In Figure 10-1 on page 198, the specific CCP pins available depend on the Stellaris[®] device. See Table 10-1 on page 198 for the available CCPs.

Figure 10-1. GPTM Module Block Diagram

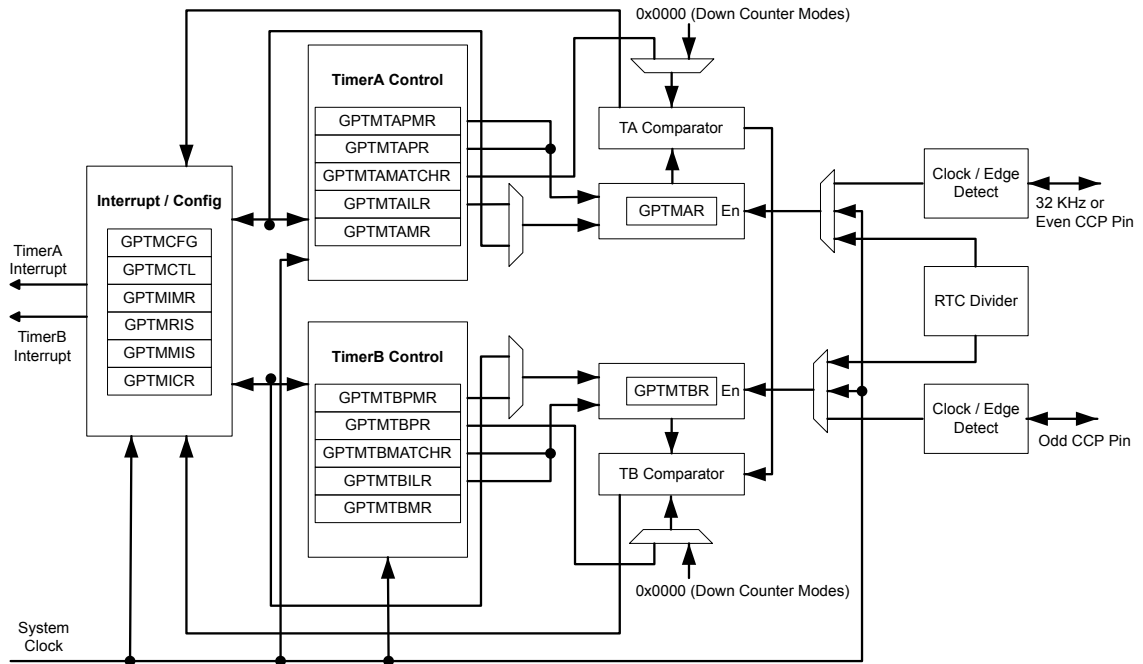

Table 10-1. Available CCP Pins

Timer	16-Bit Up/Down Counter	Even CCP Pin	Odd CCP Pin
Timer 0	TimerA	CCP0	-
	TimerB	-	CCP1
Timer 1	TimerA	CCP2	-
	TimerB	-	CCP3
Timer 2	TimerA	CCP4	-
	TimerB	-	CCP5
Timer 3	TimerA	-	-
	TimerB	-	-

10.2 Functional Description

The main components of each GPTM block are two free-running 16-bit up/down counters (referred to as TimerA and TimerB), two 16-bit match registers, two prescaler match registers, and two 16-bit load/initialization registers and their associated control functions. The exact functionality of each GPTM is controlled by software and configured through the register interface.

Software configures the GPTM using the **GPTM Configuration (GPTMCFG)** register (see page 209), the **GPTM TimerA Mode (GPTMTAMR)** register (see page 210), and the **GPTM TimerB Mode (GPTMTBMR)** register (see page 212). When in one of the 32-bit modes, the timer can only act as a 32-bit timer. However, when configured in 16-bit mode, the GPTM can have its two 16-bit timers configured in any combination of the 16-bit modes.

10.2.1 GPTM Reset Conditions

After reset has been applied to the GPTM module, the module is in an inactive state, and all control registers are cleared and in their default states. Counters TimerA and TimerB are initialized to 0xFFFF, along with their corresponding load registers: the **GPTM TimerA Interval Load (GPTMTAILR)** register (see page 223) and the **GPTM TimerB Interval Load (GPTMTBILR)** register (see page 224). The prescale counters are initialized to 0x00: the **GPTM TimerA Prescale (GPTMTAPR)** register (see page 227) and the **GPTM TimerB Prescale (GPTMTBPR)** register (see page 228).

10.2.2 32-Bit Timer Operating Modes

This section describes the three GPTM 32-bit timer modes (One-Shot, Periodic, and RTC) and their configuration.

The GPTM is placed into 32-bit mode by writing a 0 (One-Shot/Periodic 32-bit timer mode) or a 1 (RTC mode) to the **GPTM Configuration (GPTMCFG)** register. In both configurations, certain GPTM registers are concatenated to form pseudo 32-bit registers. These registers include:

- **GPTM TimerA Interval Load (GPTMTAILR)** register [15:0], see page 223
- **GPTM TimerB Interval Load (GPTMTBILR)** register [15:0], see page 224
- **GPTM TimerA (GPTMTAR)** register [15:0], see page 231
- **GPTM TimerB (GPTMTBR)** register [15:0], see page 232

In the 32-bit modes, the GPTM translates a 32-bit write access to **GPTMTAILR** into a write access to both **GPTMTAILR** and **GPTMTBILR**. The resulting word ordering for such a write operation is:

```
GPTMTBILR[15:0]:GPTMTAILR[15:0]
```

Likewise, a read access to **GPTMTAR** returns the value:

```
GPTMTBR[15:0]:GPTMTAR[15:0]
```

10.2.2.1 32-Bit One-Shot/Periodic Timer Mode

In 32-bit one-shot and periodic timer modes, the concatenated versions of the TimerA and TimerB registers are configured as a 32-bit down-counter. The selection of one-shot or periodic mode is determined by the value written to the **TAMR** field of the **GPTM TimerA Mode (GPTMTAMR)** register (see page 210), and there is no need to write to the **GPTM TimerB Mode (GPTMTBMR)** register.

When software writes the **TAEN** bit in the **GPTM Control (GPTMCTL)** register (see page 214), the timer begins counting down from its preloaded value. Once the 0x0000.0000 state is reached, the timer reloads its start value from the concatenated **GPTMTAILR** on the next cycle. If configured to be a one-shot timer, the timer stops counting and clears the **TAEN** bit in the **GPTMCTL** register. If configured as a periodic timer, it continues counting.

In addition to reloading the count value, the GPTM generates interrupts and output triggers when it reaches the 0x00000000 state. The GPTM sets the **TATORIS** bit in the **GPTM Raw Interrupt Status (GPTMRIS)** register (see page 219), and holds it until it is cleared by writing the **GPTM Interrupt Clear (GPTMICR)** register (see page 221). If the time-out interrupt is enabled in the **GPTM Interrupt Mask (GPTIMR)** register (see page 217), the GPTM also sets the **TATOMIS** bit in the **GPTM Masked Interrupt Status (GPTMMIS)** register (see page 220).

The output trigger is a one-clock-cycle pulse that is asserted when the counter hits the 0x0000.0000 state, and deasserted on the following clock cycle. It is enabled by setting the `TAOTE` bit in `GPTMCTL`, and can trigger SoC-level events such as ADC conversions.

If software reloads the `GPTMTAILR` register while the counter is running, the counter loads the new value on the next clock cycle and continues counting from the new value.

If the `TASTALL` bit in the `GPTMCTL` register is asserted, the timer freezes counting until the signal is deasserted.

10.2.2.2 32-Bit Real-Time Clock Timer Mode

In Real-Time Clock (RTC) mode, the concatenated versions of the TimerA and TimerB registers are configured as a 32-bit up-counter. When RTC mode is selected for the first time, the counter is loaded with a value of 0x0000.0001. All subsequent load values must be written to the **GPTM TimerA Match (GPTMTAMATCHR)** register (see page 225) by the controller.

The input clock on the `CCP0`, `CCP2`, or `CCP4` pins is required to be 32.768 KHz in RTC mode. The clock signal is then divided down to a 1 Hz rate and is passed along to the input of the 32-bit counter.

When software writes the `TAEN` bit in the `GPTMCTL` register, the counter starts counting up from its preloaded value of 0x0000.0001. When the current count value matches the preloaded value in the `GPTMTAMATCHR` register, it rolls over to a value of 0x0000.0000 and continues counting until either a hardware reset, or it is disabled by software (clearing the `TAEN` bit). When a match occurs, the GPTM asserts the `RTCRIS` bit in `GPTMRIS`. If the RTC interrupt is enabled in `GPTIMR`, the GPTM also sets the `RTCMIS` bit in `GPTMISR` and generates a controller interrupt. The status flags are cleared by writing the `RTCCINT` bit in `GPTMICR`.

If the `TASTALL` and/or `TBSTALL` bits in the `GPTMCTL` register are set, the timer does not freeze if the `RTCEN` bit is set in `GPTMCTL`.

10.2.3 16-Bit Timer Operating Modes

The GPTM is placed into global 16-bit mode by writing a value of 0x4 to the **GPTM Configuration (GPTMCFG)** register (see page 209). This section describes each of the GPTM 16-bit modes of operation. TimerA and TimerB have identical modes, so a single description is given using an *n* to reference both.

10.2.3.1 16-Bit One-Shot/Periodic Timer Mode

In 16-bit one-shot and periodic timer modes, the timer is configured as a 16-bit down-counter with an optional 8-bit prescaler that effectively extends the counting range of the timer to 24 bits. The selection of one-shot or periodic mode is determined by the value written to the `TnMR` field of the **GPTMTnMR** register. The optional prescaler is loaded into the **GPTM Timern Prescale (GPTMTnPR)** register.

When software writes the `TnEN` bit in the `GPTMCTL` register, the timer begins counting down from its preloaded value. Once the 0x0000 state is reached, the timer reloads its start value from `GPTMTnILR` and `GPTMTnPR` on the next cycle. If configured to be a one-shot timer, the timer stops counting and clears the `TnEN` bit in the `GPTMCTL` register. If configured as a periodic timer, it continues counting.

In addition to reloading the count value, the timer generates interrupts and output triggers when it reaches the 0x0000 state. The GPTM sets the `TnTORIS` bit in the `GPTMRIS` register, and holds it until it is cleared by writing the `GPTMICR` register. If the time-out interrupt is enabled in `GPTIMR`, the GPTM also sets the `TnTOMIS` bit in `GPTMISR` and generates a controller interrupt.

The output trigger is a one-clock-cycle pulse that is asserted when the counter hits the 0x0000 state, and deasserted on the following clock cycle. It is enabled by setting the T_{nOTE} bit in the **GPTMCTL** register, and can trigger SoC-level events such as ADC conversions.

If software reloads the **GPTMTAILR** register while the counter is running, the counter loads the new value on the next clock cycle and continues counting from the new value.

If the T_{nSTALL} bit in the **GPTMCTL** register is enabled, the timer freezes counting until the signal is deasserted.

The following example shows a variety of configurations for a 16-bit free running timer while using the prescaler. All values assume a 50-MHz clock with $T_c=20$ ns (clock period).

Table 10-2. 16-Bit Timer With Prescaler Configurations

Prescale	#Clock (T c) ^a	Max Time	Units
00000000	1	1.3107	mS
00000001	2	2.6214	mS
00000010	3	3.9321	mS
-----	--	--	--
11111100	254	332.9229	mS
11111110	255	334.2336	mS
11111111	256	335.5443	mS

a. T_c is the clock period.

10.2.3.2 16-Bit Input Edge Count Mode

In Edge Count mode, the timer is configured as a down-counter capable of capturing three types of events: rising edge, falling edge, or both. To place the timer in Edge Count mode, the T_{nCMR} bit of the **GPTMTnMR** register must be set to 0. The type of edge that the timer counts is determined by the T_{nEVENT} fields of the **GPTMCTL** register. During initialization, the **GPTM Timern Match (GPTMTnMATCHR)** register is configured so that the difference between the value in the **GPTMTnILR** register and the **GPTMTnMATCHR** register equals the number of edge events that must be counted.

When software writes the T_{nEN} bit in the **GPTM Control (GPTMCTL)** register, the timer is enabled for event capture. Each input event on the CCP pin decrements the counter by 1 until the event count matches **GPTMTnMATCHR**. When the counts match, the GPTM asserts the C_{nMRIS} bit in the **GPTMRIS** register (and the C_{nMMIS} bit, if the interrupt is not masked). The counter is then reloaded using the value in **GPTMTnILR**, and stopped since the GPTM automatically clears the T_{nEN} bit in the **GPTMCTL** register. Once the event count has been reached, all further events are ignored until T_{nEN} is re-enabled by software.

Figure 10-2 on page 202 shows how input edge count mode works. In this case, the timer start value is set to **GPTMTnILR** = 0x000A and the match value is set to **GPTMTnMATCHR** = 0x0006 so that four edge events are counted. The counter is configured to detect both edges of the input signal.

Note that the last two edges are not counted since the timer automatically clears the T_{nEN} bit after the current count matches the value in the **GPTMTnMR** register.

Figure 10-2. 16-Bit Input Edge Count Mode Example

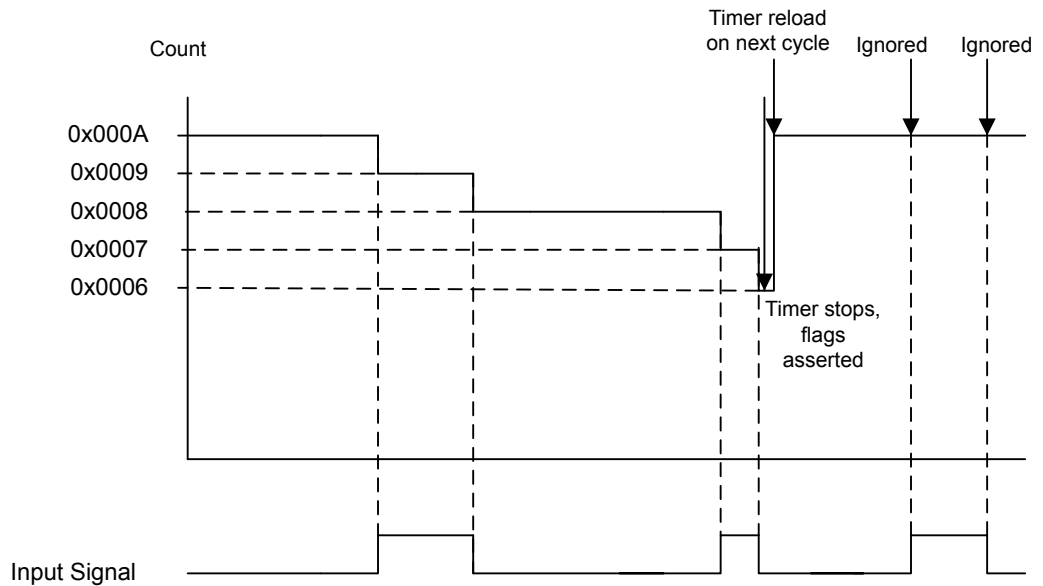

10.2.3.3 16-Bit Input Edge Time Mode

Note: The prescaler is not available in 16-Bit Input Edge Time mode.

In Edge Time mode, the timer is configured as a free-running down-counter initialized to the value loaded in the **GPTMTnILR** register (or 0xFFFF at reset). This mode allows for event capture of both rising and falling edges. The timer is placed into Edge Time mode by setting the **TnCMR** bit in the **GPTMTnMR** register, and the type of event that the timer captures is determined by the **TnEVENT** fields of the **GPTMCnTL** register.

When software writes the **TnEN** bit in the **GPTMCTL** register, the timer is enabled for event capture. When the selected input event is detected, the current **Tn** counter value is captured in the **GPTMTnR** register and is available to be read by the controller. The GPTM then asserts the **CnERIS** bit (and the **CnEMIS** bit, if the interrupt is not masked).

After an event has been captured, the timer does not stop counting. It continues to count until the **TnEN** bit is cleared. When the timer reaches the 0x0000 state, it is reloaded with the value from the **GPTMnILR** register.

Figure 10-3 on page 203 shows how input edge timing mode works. In the diagram, it is assumed that the start value of the timer is the default value of 0xFFFF, and the timer is configured to capture rising edge events.

Each time a rising edge event is detected, the current count value is loaded into the **GPTMTnR** register, and is held there until another rising edge is detected (at which point the new count value is loaded into **GPTMTnR**).

Figure 10-3. 16-Bit Input Edge Time Mode Example

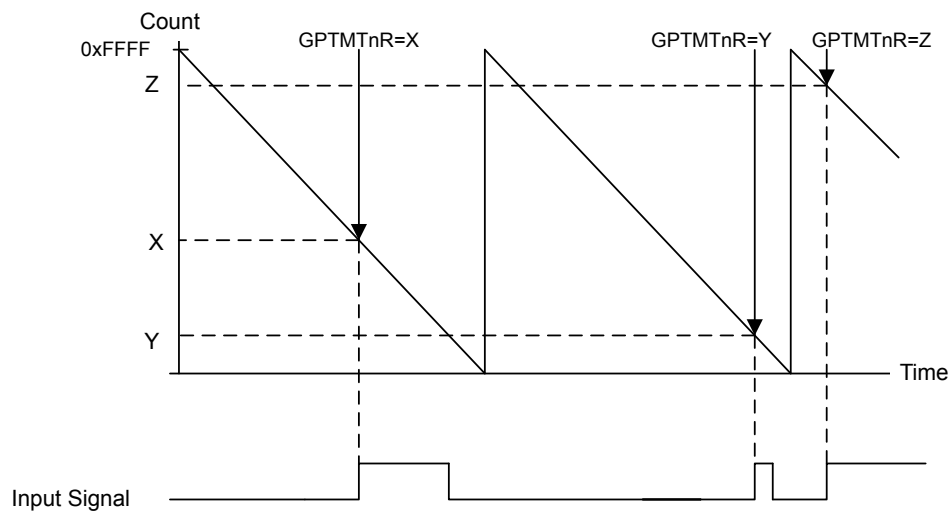

10.2.3.4 16-Bit PWM Mode

The GPTM supports a simple PWM generation mode. In PWM mode, the timer is configured as a down-counter with a start value (and thus period) defined by **GPTMTnILR**. PWM mode is enabled with the **GPTMTnMR** register by setting the T_nAMS bit to 0x1, the T_nCMR bit to 0x0, and the T_nMR field to 0x2.

When software writes the T_nEN bit in the **GPTMCTL** register, the counter begins counting down until it reaches the 0x0000 state. On the next counter cycle, the counter reloads its start value from **GPTMTnILR** (and **GPTMTnPR** if using a prescaler) and continues counting until disabled by software clearing the T_nEN bit in the **GPTMCTL** register. No interrupts or status bits are asserted in PWM mode.

The output PWM signal asserts when the counter is at the value of the **GPTMTnILR** register (its start state), and is deasserted when the counter value equals the value in the **GPTM Timern Match Register (GPTMnMATCHR)**. Software has the capability of inverting the output PWM signal by setting the T_nPWML bit in the **GPTMCTL** register.

Figure 10-4 on page 204 shows how to generate an output PWM with a 1-ms period and a 66% duty cycle assuming a 50-MHz input clock and $T_nPWML = 0$ (duty cycle would be 33% for the $T_nPWML = 1$ configuration). For this example, the start value is **GPTMnILR**=0xC350 and the match value is **GPTMnMR**=0x411A.

Figure 10-4. 16-Bit PWM Mode Example

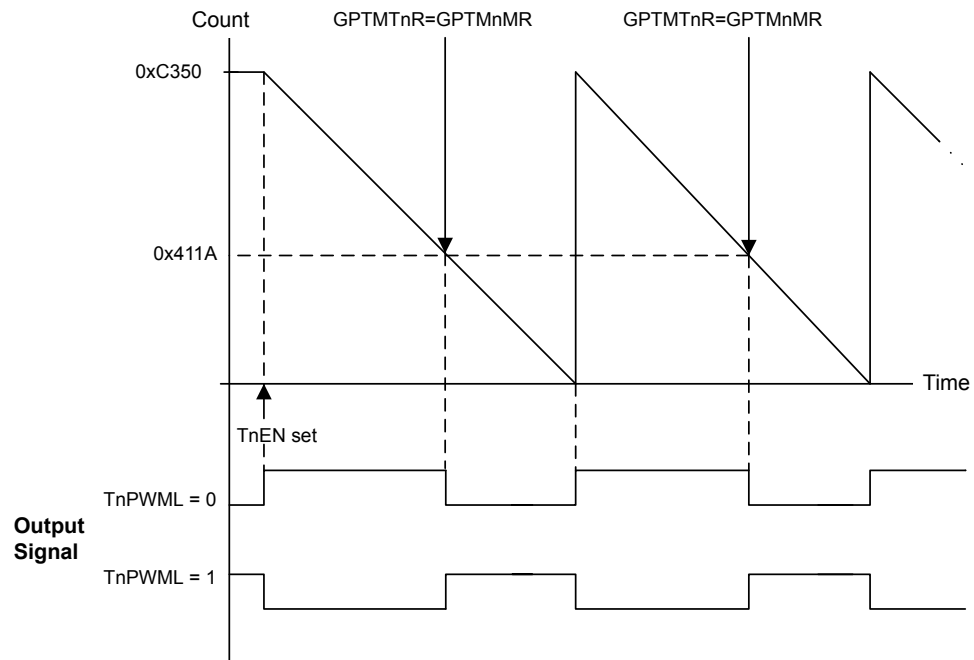

10.3 Initialization and Configuration

To use the general-purpose timers, the peripheral clock must be enabled by setting the `TIMER0`, `TIMER1`, `TIMER2`, and `TIMER3` bits in the `RCGC1` register.

This section shows module initialization and configuration examples for each of the supported timer modes.

10.3.1 32-Bit One-Shot/Periodic Timer Mode

The GPTM is configured for 32-bit One-Shot and Periodic modes by the following sequence:

1. Ensure the timer is disabled (the `TAEN` bit in the `GPTMCTL` register is cleared) before making any changes.
2. Write the **GPTM Configuration Register (GPTMCFG)** with a value of 0x0.
3. Set the `TAMR` field in the **GPTM TimerA Mode Register (GPTMTAMR)**:
 - a. Write a value of 0x1 for One-Shot mode.
 - b. Write a value of 0x2 for Periodic mode.
4. Load the start value into the **GPTM TimerA Interval Load Register (GPTMTAILR)**.
5. If interrupts are required, set the `TATOIM` bit in the **GPTM Interrupt Mask Register (GPTMIMR)**.
6. Set the `TAEN` bit in the `GPTMCTL` register to enable the timer and start counting.

7. Poll the `TATORIS` bit in the **GPTMRIS** register or wait for the interrupt to be generated (if enabled). In both cases, the status flags are cleared by writing a 1 to the `TATOCINT` bit of the **GPTM Interrupt Clear Register (GPTMICR)**.

In One-Shot mode, the timer stops counting after step 7 on page 205. To re-enable the timer, repeat the sequence. A timer configured in Periodic mode does not stop counting after it times out.

10.3.2 32-Bit Real-Time Clock (RTC) Mode

To use the RTC mode, the timer must have a 32.768-KHz input signal on its `CCP0`, `CCP2`, or `CCP4` pins. To enable the RTC feature, follow these steps:

1. Ensure the timer is disabled (the `TAEN` bit is cleared) before making any changes.
2. Write the **GPTM Configuration Register (GPTMCFG)** with a value of `0x1`.
3. Write the desired match value to the **GPTM TimerA Match Register (GPTMTAMATCHR)**.
4. Set/clear the `RTCEN` bit in the **GPTM Control Register (GPTMCTL)** as desired.
5. If interrupts are required, set the `RTCIM` bit in the **GPTM Interrupt Mask Register (GPTMIMR)**.
6. Set the `TAEN` bit in the **GPTMCTL** register to enable the timer and start counting.

When the timer count equals the value in the **GPTMTAMATCHR** register, the counter is re-loaded with `0x0000.0000` and begins counting. If an interrupt is enabled, it does not have to be cleared.

10.3.3 16-Bit One-Shot/Periodic Timer Mode

A timer is configured for 16-bit One-Shot and Periodic modes by the following sequence:

1. Ensure the timer is disabled (the `TnEN` bit is cleared) before making any changes.
2. Write the **GPTM Configuration Register (GPTMCFG)** with a value of `0x4`.
3. Set the `TnMR` field in the **GPTM Timer Mode (GPTMTnMR)** register:
 - a. Write a value of `0x1` for One-Shot mode.
 - b. Write a value of `0x2` for Periodic mode.
4. If a prescaler is to be used, write the prescale value to the **GPTM Timern Prescale Register (GPTMTnPR)**.
5. Load the start value into the **GPTM Timer Interval Load Register (GPTMTnILR)**.
6. If interrupts are required, set the `TnTOIM` bit in the **GPTM Interrupt Mask Register (GPTMIMR)**.
7. Set the `TnEN` bit in the **GPTM Control Register (GPTMCTL)** to enable the timer and start counting.
8. Poll the `TnTORIS` bit in the **GPTMRIS** register or wait for the interrupt to be generated (if enabled). In both cases, the status flags are cleared by writing a 1 to the `TnTOCINT` bit of the **GPTM Interrupt Clear Register (GPTMICR)**.

In One-Shot mode, the timer stops counting after step 8 on page 205. To re-enable the timer, repeat the sequence. A timer configured in Periodic mode does not stop counting after it times out.

10.3.4 16-Bit Input Edge Count Mode

A timer is configured to Input Edge Count mode by the following sequence:

1. Ensure the timer is disabled (the $TnEN$ bit is cleared) before making any changes.
2. Write the **GPTM Configuration (GPTMCFG)** register with a value of 0x4.
3. In the **GPTM Timer Mode (GPTMTnMR)** register, write the $TnCMR$ field to 0x0 and the $TnMR$ field to 0x3.
4. Configure the type of event(s) that the timer captures by writing the $TnEVENT$ field of the **GPTM Control (GPTMCTL)** register.
5. Load the timer start value into the **GPTM Timern Interval Load (GPTMTnILR)** register.
6. Load the desired event count into the **GPTM Timern Match (GPTMTnMATCHR)** register.
7. If interrupts are required, set the $CnMIM$ bit in the **GPTM Interrupt Mask (GPTMIMR)** register.
8. Set the $TnEN$ bit in the **GPTMCTL** register to enable the timer and begin waiting for edge events.
9. Poll the $CnMRIS$ bit in the **GPTMRIS** register or wait for the interrupt to be generated (if enabled). In both cases, the status flags are cleared by writing a 1 to the $CnMCINT$ bit of the **GPTM Interrupt Clear (GPTMICR)** register.

In Input Edge Count Mode, the timer stops after the desired number of edge events has been detected. To re-enable the timer, ensure that the $TnEN$ bit is cleared and repeat step 4 on page 206 through step 9 on page 206.

10.3.5 16-Bit Input Edge Timing Mode

A timer is configured to Input Edge Timing mode by the following sequence:

1. Ensure the timer is disabled (the $TnEN$ bit is cleared) before making any changes.
2. Write the **GPTM Configuration (GPTMCFG)** register with a value of 0x4.
3. In the **GPTM Timer Mode (GPTMTnMR)** register, write the $TnCMR$ field to 0x1 and the $TnMR$ field to 0x3.
4. Configure the type of event that the timer captures by writing the $TnEVENT$ field of the **GPTM Control (GPTMCTL)** register.
5. Load the timer start value into the **GPTM Timern Interval Load (GPTMTnILR)** register.
6. If interrupts are required, set the $CnEIM$ bit in the **GPTM Interrupt Mask (GPTMIMR)** register.
7. Set the $TnEN$ bit in the **GPTM Control (GPTMCTL)** register to enable the timer and start counting.
8. Poll the $CnERIS$ bit in the **GPTMRIS** register or wait for the interrupt to be generated (if enabled). In both cases, the status flags are cleared by writing a 1 to the $CnECINT$ bit of the **GPTM**

Interrupt Clear (GPTMICR) register. The time at which the event happened can be obtained by reading the **GPTM Timern (GPTMTnR)** register.

In Input Edge Timing mode, the timer continues running after an edge event has been detected, but the timer interval can be changed at any time by writing the **GPTMTnILR** register. The change takes effect at the next cycle after the write.

10.3.6 16-Bit PWM Mode

A timer is configured to PWM mode using the following sequence:

1. Ensure the timer is disabled (the T_{nEN} bit is cleared) before making any changes.
2. Write the **GPTM Configuration (GPTMCFG)** register with a value of 0x4.
3. In the **GPTM Timer Mode (GPTMTnMR)** register, set the T_{nAMS} bit to 0x1, the T_{nCMR} bit to 0x0, and the T_{nMR} field to 0x2.
4. Configure the output state of the PWM signal (whether or not it is inverted) in the T_{nEVENT} field of the **GPTM Control (GPTMCTL)** register.
5. Load the timer start value into the **GPTM Timern Interval Load (GPTMTnILR)** register.
6. Load the **GPTM Timern Match (GPTMTnMATCHR)** register with the desired value.
7. If a prescaler is going to be used, configure the **GPTM Timern Prescale (GPTMTnPR)** register and the **GPTM Timern Prescale Match (GPTMTnPMR)** register.
8. Set the T_{nEN} bit in the **GPTM Control (GPTMCTL)** register to enable the timer and begin generation of the output PWM signal.

In PWM Timing mode, the timer continues running after the PWM signal has been generated. The PWM period can be adjusted at any time by writing the **GPTMTnILR** register, and the change takes effect at the next cycle after the write.

10.4 Register Map

Table 10-3 on page 207 lists the GPTM registers. The offset listed is a hexadecimal increment to the register's address, relative to that timer's base address:

- Timer0: 0x4003.0000
- Timer1: 0x4003.1000
- Timer2: 0x4003.2000
- Timer3: 0x4003.3000

Table 10-3. Timers Register Map

Offset	Name	Type	Reset	Description	See page
0x000	GPTMCFG	R/W	0x0000.0000	GPTM Configuration	209
0x004	GPTMTAMR	R/W	0x0000.0000	GPTM TimerA Mode	210

Offset	Name	Type	Reset	Description	See page
0x008	GPTMTBMR	R/W	0x0000.0000	GPTM TimerB Mode	212
0x00C	GPTMCTL	R/W	0x0000.0000	GPTM Control	214
0x018	GPTMIMR	R/W	0x0000.0000	GPTM Interrupt Mask	217
0x01C	GPTMRIS	RO	0x0000.0000	GPTM Raw Interrupt Status	219
0x020	GPTMMIS	RO	0x0000.0000	GPTM Masked Interrupt Status	220
0x024	GPTMICR	W1C	0x0000.0000	GPTM Interrupt Clear	221
0x028	GPTMTAILR	R/W	0x0000.FFFF (16-bit mode) 0xFFFF.FFFF (32-bit mode)	GPTM TimerA Interval Load	223
0x02C	GPTMTBILR	R/W	0x0000.FFFF	GPTM TimerB Interval Load	224
0x030	GPTMTAMATCHR	R/W	0x0000.FFFF (16-bit mode) 0xFFFF.FFFF (32-bit mode)	GPTM TimerA Match	225
0x034	GPTMTBMATCHR	R/W	0x0000.FFFF	GPTM TimerB Match	226
0x038	GPTMTAPR	R/W	0x0000.0000	GPTM TimerA Prescale	227
0x03C	GPTMTBPR	R/W	0x0000.0000	GPTM TimerB Prescale	228
0x040	GPTMTAPMR	R/W	0x0000.0000	GPTM TimerA Prescale Match	229
0x044	GPTMTBPMR	R/W	0x0000.0000	GPTM TimerB Prescale Match	230
0x048	GPTMTAR	RO	0x0000.FFFF (16-bit mode) 0xFFFF.FFFF (32-bit mode)	GPTM TimerA	231
0x04C	GPTMTBR	RO	0x0000.FFFF	GPTM TimerB	232

10.5 Register Descriptions

The remainder of this section lists and describes the GPTM registers, in numerical order by address offset.

Register 1: GPTM Configuration (GPTMCFG), offset 0x000

This register configures the global operation of the GPTM module. The value written to this register determines whether the GPTM is in 32- or 16-bit mode.

GPTM Configuration (GPTMCFG)

Timer0 base: 0x4003.0000
 Timer1 base: 0x4003.1000
 Timer2 base: 0x4003.2000
 Timer3 base: 0x4003.3000
 Offset 0x000
 Type R/W, reset 0x0000.0000

	31	30	29	28	27	26	25	24	23	22	21	20	19	18	17	16	
	reserved																
Type	RO	RO	RO	RO	RO	RO	RO	RO	RO	RO	RO	RO	RO	RO	RO	RO	
Reset	0	0	0	0	0	0	0	0	0	0	0	0	0	0	0	0	
	15	14	13	12	11	10	9	8	7	6	5	4	3	2	1	0	
	reserved													GPTMCFG			
Type	RO	RO	RO	RO	RO	RO	RO	RO	RO	RO	RO	RO	RO	RO	R/W	R/W	R/W
Reset	0	0	0	0	0	0	0	0	0	0	0	0	0	0	0	0	0

Bit/Field	Name	Type	Reset	Description
31:3	reserved	RO	0x00	Software should not rely on the value of a reserved bit. To provide compatibility with future products, the value of a reserved bit should be preserved across a read-modify-write operation.
2:0	GPTMCFG	R/W	0x0	GPTM Configuration

The GPTMCFG values are defined as follows:

Value	Description
0x0	32-bit timer configuration.
0x1	32-bit real-time clock (RTC) counter configuration.
0x2	Reserved.
0x3	Reserved.
0x4-0x7	16-bit timer configuration, function is controlled by bits 1:0 of GPTMTAMR and GPTMTBMR .

Register 2: GPTM TimerA Mode (GPTMTAMR), offset 0x004

This register configures the GPTM based on the configuration selected in the **GPTMCFG** register. When in 16-bit PWM mode, set the **TAAMS** bit to 0x1, the **TACMR** bit to 0x0, and the **TAMR** field to 0x2.

GPTM TimerA Mode (GPTMTAMR)

Timer0 base: 0x4003.0000
 Timer1 base: 0x4003.1000
 Timer2 base: 0x4003.2000
 Timer3 base: 0x4003.3000
 Offset 0x004
 Type R/W, reset 0x0000.0000

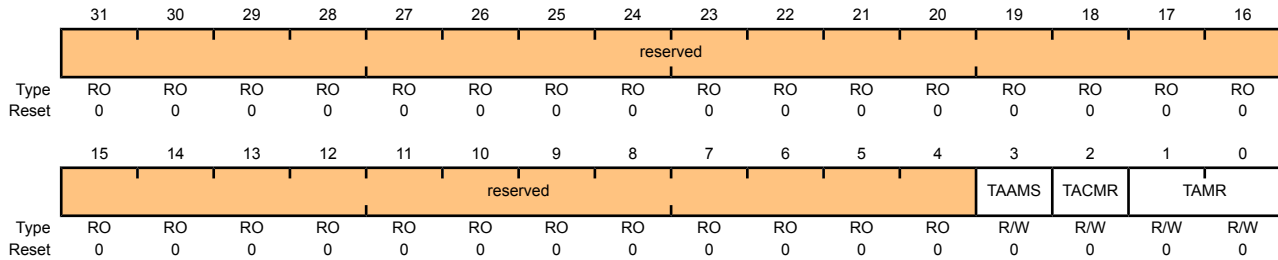

Bit/Field	Name	Type	Reset	Description						
31:4	reserved	RO	0x00	Software should not rely on the value of a reserved bit. To provide compatibility with future products, the value of a reserved bit should be preserved across a read-modify-write operation.						
3	TAAMS	R/W	0	GPTM TimerA Alternate Mode Select The TAAMS values are defined as follows: <table border="1"> <thead> <tr> <th>Value</th> <th>Description</th> </tr> </thead> <tbody> <tr> <td>0</td> <td>Capture mode is enabled.</td> </tr> <tr> <td>1</td> <td>PWM mode is enabled.</td> </tr> </tbody> </table> <p>Note: To enable PWM mode, you must also clear the TACMR bit and set the TAMR field to 0x2.</p>	Value	Description	0	Capture mode is enabled.	1	PWM mode is enabled.
Value	Description									
0	Capture mode is enabled.									
1	PWM mode is enabled.									
2	TACMR	R/W	0	GPTM TimerA Capture Mode The TACMR values are defined as follows: <table border="1"> <thead> <tr> <th>Value</th> <th>Description</th> </tr> </thead> <tbody> <tr> <td>0</td> <td>Edge-Count mode.</td> </tr> <tr> <td>1</td> <td>Edge-Time mode.</td> </tr> </tbody> </table>	Value	Description	0	Edge-Count mode.	1	Edge-Time mode.
Value	Description									
0	Edge-Count mode.									
1	Edge-Time mode.									

Bit/Field	Name	Type	Reset	Description										
1:0	TAMR	R/W	0x0	<p>GPTM TimerA Mode</p> <p>The TAMR values are defined as follows:</p> <table><thead><tr><th>Value</th><th>Description</th></tr></thead><tbody><tr><td>0x0</td><td>Reserved.</td></tr><tr><td>0x1</td><td>One-Shot Timer mode.</td></tr><tr><td>0x2</td><td>Periodic Timer mode.</td></tr><tr><td>0x3</td><td>Capture mode.</td></tr></tbody></table> <p>The Timer mode is based on the timer configuration defined by bits 2:0 in the GPTMCFG register (16-or 32-bit).</p> <p>In 16-bit timer configuration, TAMR controls the 16-bit timer modes for TimerA.</p> <p>In 32-bit timer configuration, this register controls the mode and the contents of GPTMTBMR are ignored.</p>	Value	Description	0x0	Reserved.	0x1	One-Shot Timer mode.	0x2	Periodic Timer mode.	0x3	Capture mode.
Value	Description													
0x0	Reserved.													
0x1	One-Shot Timer mode.													
0x2	Periodic Timer mode.													
0x3	Capture mode.													

Register 3: GPTM TimerB Mode (GPTMTBMR), offset 0x008

This register configures the GPTM based on the configuration selected in the **GPTMCFG** register. When in 16-bit PWM mode, set the **TBAMS** bit to 0x1, the **TBCMR** bit to 0x0, and the **TBMR** field to 0x2.

GPTM TimerB Mode (GPTMTBMR)

Timer0 base: 0x4003.0000
 Timer1 base: 0x4003.1000
 Timer2 base: 0x4003.2000
 Timer3 base: 0x4003.3000
 Offset 0x008
 Type R/W, reset 0x0000.0000

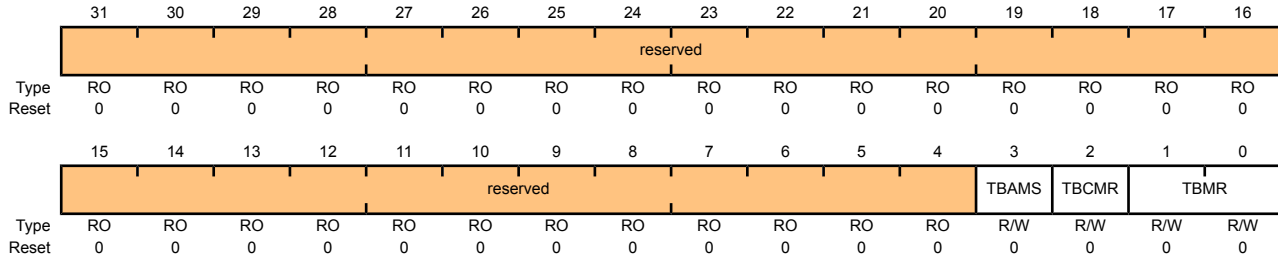

Bit/Field	Name	Type	Reset	Description						
31:4	reserved	RO	0x00	Software should not rely on the value of a reserved bit. To provide compatibility with future products, the value of a reserved bit should be preserved across a read-modify-write operation.						
3	TBAMS	R/W	0	GPTM TimerB Alternate Mode Select The TBAMS values are defined as follows: <table border="1"> <thead> <tr> <th>Value</th> <th>Description</th> </tr> </thead> <tbody> <tr> <td>0</td> <td>Capture mode is enabled.</td> </tr> <tr> <td>1</td> <td>PWM mode is enabled.</td> </tr> </tbody> </table> <p>Note: To enable PWM mode, you must also clear the TBCMR bit and set the TBMR field to 0x2.</p>	Value	Description	0	Capture mode is enabled.	1	PWM mode is enabled.
Value	Description									
0	Capture mode is enabled.									
1	PWM mode is enabled.									
2	TBCMR	R/W	0	GPTM TimerB Capture Mode The TBCMR values are defined as follows: <table border="1"> <thead> <tr> <th>Value</th> <th>Description</th> </tr> </thead> <tbody> <tr> <td>0</td> <td>Edge-Count mode.</td> </tr> <tr> <td>1</td> <td>Edge-Time mode.</td> </tr> </tbody> </table>	Value	Description	0	Edge-Count mode.	1	Edge-Time mode.
Value	Description									
0	Edge-Count mode.									
1	Edge-Time mode.									

Bit/Field	Name	Type	Reset	Description										
1:0	TBMR	R/W	0x0	<p>GPTM TimerB Mode</p> <p>The TBMR values are defined as follows:</p> <table><thead><tr><th>Value</th><th>Description</th></tr></thead><tbody><tr><td>0x0</td><td>Reserved.</td></tr><tr><td>0x1</td><td>One-Shot Timer mode.</td></tr><tr><td>0x2</td><td>Periodic Timer mode.</td></tr><tr><td>0x3</td><td>Capture mode.</td></tr></tbody></table> <p>The timer mode is based on the timer configuration defined by bits 2:0 in the GPTMCFG register.</p> <p>In 16-bit timer configuration, these bits control the 16-bit timer modes for TimerB.</p> <p>In 32-bit timer configuration, this register's contents are ignored and GPTMTAMR is used.</p>	Value	Description	0x0	Reserved.	0x1	One-Shot Timer mode.	0x2	Periodic Timer mode.	0x3	Capture mode.
Value	Description													
0x0	Reserved.													
0x1	One-Shot Timer mode.													
0x2	Periodic Timer mode.													
0x3	Capture mode.													

Register 4: GPTM Control (GPTMCTL), offset 0x00C

This register is used alongside the **GPTMCFG** and **GMTMTnMR** registers to fine-tune the timer configuration, and to enable other features such as timer stall and the output trigger. The output trigger can be used to initiate transfers on the ADC module.

GPTM Control (GPTMCTL)

Timer0 base: 0x4003.0000
 Timer1 base: 0x4003.1000
 Timer2 base: 0x4003.2000
 Timer3 base: 0x4003.3000
 Offset 0x00C
 Type R/W, reset 0x0000.0000

	31	30	29	28	27	26	25	24	23	22	21	20	19	18	17	16
	reserved															
Type	RO	RO	RO	RO	RO	RO	RO	RO	RO	RO	RO	RO	RO	RO	RO	RO
Reset	0	0	0	0	0	0	0	0	0	0	0	0	0	0	0	0
	15	14	13	12	11	10	9	8	7	6	5	4	3	2	1	0
	reserved	TBPWML	TBOTE	reserved	TBEVENT	TBSTALL	TBEN	reserved	TAPWML	TAOTE	RTCEN	TAEVENT	TASTALL	TAEN		
Type	RO	R/W	R/W	RO	R/W	R/W	R/W	RO	R/W	R/W	R/W	R/W	R/W	R/W	R/W	R/W
Reset	0	0	0	0	0	0	0	0	0	0	0	0	0	0	0	0

Bit/Field	Name	Type	Reset	Description
31:15	reserved	RO	0x00	Software should not rely on the value of a reserved bit. To provide compatibility with future products, the value of a reserved bit should be preserved across a read-modify-write operation.
14	TBPWML	R/W	0	GPTM TimerB PWM Output Level The TBPWML values are defined as follows: Value Description 0 Output is unaffected. 1 Output is inverted.
13	TBOTE	R/W	0	GPTM TimerB Output Trigger Enable The TBOTE values are defined as follows: Value Description 0 The output TimerB trigger is disabled. 1 The output TimerB trigger is enabled.
12	reserved	RO	0	Software should not rely on the value of a reserved bit. To provide compatibility with future products, the value of a reserved bit should be preserved across a read-modify-write operation.

Bit/Field	Name	Type	Reset	Description										
11:10	TBEVENT	R/W	0x0	<p>GPTM TimerB Event Mode</p> <p>The TBEVENT values are defined as follows:</p> <table border="1"> <thead> <tr> <th>Value</th> <th>Description</th> </tr> </thead> <tbody> <tr> <td>0x0</td> <td>Positive edge.</td> </tr> <tr> <td>0x1</td> <td>Negative edge.</td> </tr> <tr> <td>0x2</td> <td>Reserved</td> </tr> <tr> <td>0x3</td> <td>Both edges.</td> </tr> </tbody> </table>	Value	Description	0x0	Positive edge.	0x1	Negative edge.	0x2	Reserved	0x3	Both edges.
Value	Description													
0x0	Positive edge.													
0x1	Negative edge.													
0x2	Reserved													
0x3	Both edges.													
9	TBSTALL	R/W	0	<p>GPTM TimerB Stall Enable</p> <p>The TBSTALL values are defined as follows:</p> <table border="1"> <thead> <tr> <th>Value</th> <th>Description</th> </tr> </thead> <tbody> <tr> <td>0</td> <td>TimerB stalling is disabled.</td> </tr> <tr> <td>1</td> <td>TimerB stalling is enabled.</td> </tr> </tbody> </table>	Value	Description	0	TimerB stalling is disabled.	1	TimerB stalling is enabled.				
Value	Description													
0	TimerB stalling is disabled.													
1	TimerB stalling is enabled.													
8	TBEN	R/W	0	<p>GPTM TimerB Enable</p> <p>The TBEN values are defined as follows:</p> <table border="1"> <thead> <tr> <th>Value</th> <th>Description</th> </tr> </thead> <tbody> <tr> <td>0</td> <td>TimerB is disabled.</td> </tr> <tr> <td>1</td> <td>TimerB is enabled and begins counting or the capture logic is enabled based on the GPTMCFG register.</td> </tr> </tbody> </table>	Value	Description	0	TimerB is disabled.	1	TimerB is enabled and begins counting or the capture logic is enabled based on the GPTMCFG register.				
Value	Description													
0	TimerB is disabled.													
1	TimerB is enabled and begins counting or the capture logic is enabled based on the GPTMCFG register.													
7	reserved	RO	0	Software should not rely on the value of a reserved bit. To provide compatibility with future products, the value of a reserved bit should be preserved across a read-modify-write operation.										
6	TAPWML	R/W	0	<p>GPTM TimerA PWM Output Level</p> <p>The TAPWML values are defined as follows:</p> <table border="1"> <thead> <tr> <th>Value</th> <th>Description</th> </tr> </thead> <tbody> <tr> <td>0</td> <td>Output is unaffected.</td> </tr> <tr> <td>1</td> <td>Output is inverted.</td> </tr> </tbody> </table>	Value	Description	0	Output is unaffected.	1	Output is inverted.				
Value	Description													
0	Output is unaffected.													
1	Output is inverted.													
5	TAOTE	R/W	0	<p>GPTM TimerA Output Trigger Enable</p> <p>The TAOTE values are defined as follows:</p> <table border="1"> <thead> <tr> <th>Value</th> <th>Description</th> </tr> </thead> <tbody> <tr> <td>0</td> <td>The output TimerA trigger is disabled.</td> </tr> <tr> <td>1</td> <td>The output TimerA trigger is enabled.</td> </tr> </tbody> </table>	Value	Description	0	The output TimerA trigger is disabled.	1	The output TimerA trigger is enabled.				
Value	Description													
0	The output TimerA trigger is disabled.													
1	The output TimerA trigger is enabled.													

Bit/Field	Name	Type	Reset	Description
4	RTCEN	R/W	0	GPTM RTC Enable The <code>RTCEN</code> values are defined as follows: Value Description 0 RTC counting is disabled. 1 RTC counting is enabled.
3:2	TAEVENT	R/W	0x0	GPTM TimerA Event Mode The <code>TAEVENT</code> values are defined as follows: Value Description 0x0 Positive edge. 0x1 Negative edge. 0x2 Reserved 0x3 Both edges.
1	TASTALL	R/W	0	GPTM TimerA Stall Enable The <code>TASTALL</code> values are defined as follows: Value Description 0 TimerA stalling is disabled. 1 TimerA stalling is enabled.
0	TAEN	R/W	0	GPTM TimerA Enable The <code>TAEN</code> values are defined as follows: Value Description 0 TimerA is disabled. 1 TimerA is enabled and begins counting or the capture logic is enabled based on the <code>GPTMCFG</code> register.

Register 5: GPTM Interrupt Mask (GPTMIMR), offset 0x018

This register allows software to enable/disable GPTM controller-level interrupts. Writing a 1 enables the interrupt, while writing a 0 disables it.

GPTM Interrupt Mask (GPTMIMR)

Timer0 base: 0x4003.0000
 Timer1 base: 0x4003.1000
 Timer2 base: 0x4003.2000
 Timer3 base: 0x4003.3000
 Offset 0x018
 Type R/W, reset 0x0000.0000

	31	30	29	28	27	26	25	24	23	22	21	20	19	18	17	16
	reserved															
Type	RO	RO	RO	RO	RO	RO	RO	RO	RO	RO	RO	RO	RO	RO	RO	RO
Reset	0	0	0	0	0	0	0	0	0	0	0	0	0	0	0	0
	15	14	13	12	11	10	9	8	7	6	5	4	3	2	1	0
	reserved					CBEIM	CBMIM	TBTOIM	reserved				RTCIM	CAEIM	CAMIM	TATOIM
Type	RO	RO	RO	RO	RO	R/W	R/W	R/W	RO	RO	RO	RO	R/W	R/W	R/W	R/W
Reset	0	0	0	0	0	0	0	0	0	0	0	0	0	0	0	0

Bit/Field	Name	Type	Reset	Description
31:11	reserved	RO	0x00	Software should not rely on the value of a reserved bit. To provide compatibility with future products, the value of a reserved bit should be preserved across a read-modify-write operation.
10	CBEIM	R/W	0	GPTM CaptureB Event Interrupt Mask The CBEIM values are defined as follows: Value Description 0 Interrupt is disabled. 1 Interrupt is enabled.
9	CBMIM	R/W	0	GPTM CaptureB Match Interrupt Mask The CBMIM values are defined as follows: Value Description 0 Interrupt is disabled. 1 Interrupt is enabled.
8	TBTOIM	R/W	0	GPTM TimerB Time-Out Interrupt Mask The TBTOIM values are defined as follows: Value Description 0 Interrupt is disabled. 1 Interrupt is enabled.
7:4	reserved	RO	0	Software should not rely on the value of a reserved bit. To provide compatibility with future products, the value of a reserved bit should be preserved across a read-modify-write operation.

Bit/Field	Name	Type	Reset	Description
3	RTCIM	R/W	0	GPTM RTC Interrupt Mask The RTCIM values are defined as follows: Value Description 0 Interrupt is disabled. 1 Interrupt is enabled.
2	CAEIM	R/W	0	GPTM CaptureA Event Interrupt Mask The CAEIM values are defined as follows: Value Description 0 Interrupt is disabled. 1 Interrupt is enabled.
1	CAMIM	R/W	0	GPTM CaptureA Match Interrupt Mask The CAMIM values are defined as follows: Value Description 0 Interrupt is disabled. 1 Interrupt is enabled.
0	TATOIM	R/W	0	GPTM TimerA Time-Out Interrupt Mask The TATOIM values are defined as follows: Value Description 0 Interrupt is disabled. 1 Interrupt is enabled.

Register 6: GPTM Raw Interrupt Status (GPTMRIS), offset 0x01C

This register shows the state of the GPTM's internal interrupt signal. These bits are set whether or not the interrupt is masked in the **GPTMIMR** register. Each bit can be cleared by writing a 1 to its corresponding bit in **GPTMICR**.

GPTM Raw Interrupt Status (GPTMRIS)

Timer0 base: 0x4003.0000
 Timer1 base: 0x4003.1000
 Timer2 base: 0x4003.2000
 Timer3 base: 0x4003.3000
 Offset 0x01C
 Type RO, reset 0x0000.0000

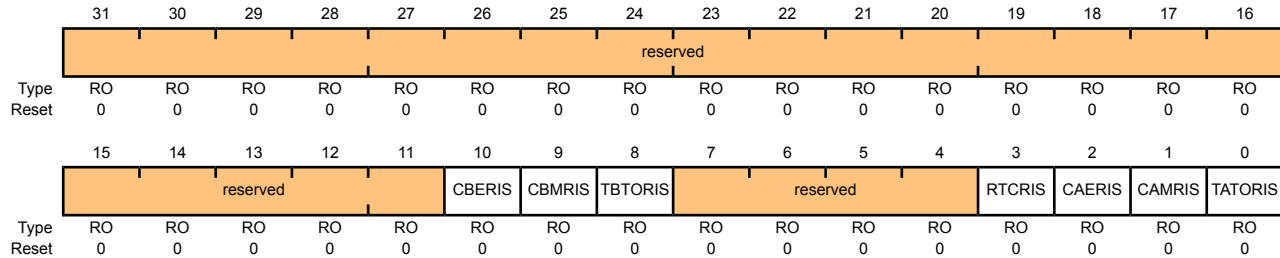

Bit/Field	Name	Type	Reset	Description
31:11	reserved	RO	0x00	Software should not rely on the value of a reserved bit. To provide compatibility with future products, the value of a reserved bit should be preserved across a read-modify-write operation.
10	CBERIS	RO	0	GPTM CaptureB Event Raw Interrupt This is the CaptureB Event interrupt status prior to masking.
9	CBMRIS	RO	0	GPTM CaptureB Match Raw Interrupt This is the CaptureB Match interrupt status prior to masking.
8	TBTORIS	RO	0	GPTM TimerB Time-Out Raw Interrupt This is the TimerB time-out interrupt status prior to masking.
7:4	reserved	RO	0x0	Software should not rely on the value of a reserved bit. To provide compatibility with future products, the value of a reserved bit should be preserved across a read-modify-write operation.
3	RTCRIS	RO	0	GPTM RTC Raw Interrupt This is the RTC Event interrupt status prior to masking.
2	CAERIS	RO	0	GPTM CaptureA Event Raw Interrupt This is the CaptureA Event interrupt status prior to masking.
1	CAMRIS	RO	0	GPTM CaptureA Match Raw Interrupt This is the CaptureA Match interrupt status prior to masking.
0	TATORIS	RO	0	GPTM TimerA Time-Out Raw Interrupt This the TimerA time-out interrupt status prior to masking.

Register 7: GPTM Masked Interrupt Status (GPTMMIS), offset 0x020

This register show the state of the GPTM's controller-level interrupt. If an interrupt is unmasked in **GPTMIMR**, and there is an event that causes the interrupt to be asserted, the corresponding bit is set in this register. All bits are cleared by writing a 1 to the corresponding bit in **GPTMICR**.

GPTM Masked Interrupt Status (GPTMMIS)

Timer0 base: 0x4003.0000
 Timer1 base: 0x4003.1000
 Timer2 base: 0x4003.2000
 Timer3 base: 0x4003.3000
 Offset 0x020
 Type RO, reset 0x0000.0000

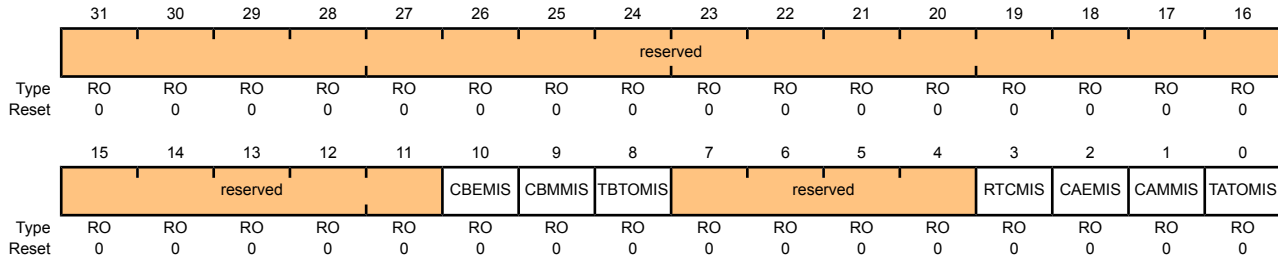

Bit/Field	Name	Type	Reset	Description
31:11	reserved	RO	0x00	Software should not rely on the value of a reserved bit. To provide compatibility with future products, the value of a reserved bit should be preserved across a read-modify-write operation.
10	CBEMIS	RO	0	GPTM CaptureB Event Masked Interrupt This is the CaptureB event interrupt status after masking.
9	CBMMIS	RO	0	GPTM CaptureB Match Masked Interrupt This is the CaptureB match interrupt status after masking.
8	TBTOMIS	RO	0	GPTM TimerB Time-Out Masked Interrupt This is the TimerB time-out interrupt status after masking.
7:4	reserved	RO	0x0	Software should not rely on the value of a reserved bit. To provide compatibility with future products, the value of a reserved bit should be preserved across a read-modify-write operation.
3	RTCMIS	RO	0	GPTM RTC Masked Interrupt This is the RTC event interrupt status after masking.
2	CAEMIS	RO	0	GPTM CaptureA Event Masked Interrupt This is the CaptureA event interrupt status after masking.
1	CAMMIS	RO	0	GPTM CaptureA Match Masked Interrupt This is the CaptureA match interrupt status after masking.
0	TATOMIS	RO	0	GPTM TimerA Time-Out Masked Interrupt This is the TimerA time-out interrupt status after masking.

Register 8: GPTM Interrupt Clear (GPTMICR), offset 0x024

This register is used to clear the status bits in the **GPTMRIS** and **GPTMMIS** registers. Writing a 1 to a bit clears the corresponding bit in the **GPTMRIS** and **GPTMMIS** registers.

GPTM Interrupt Clear (GPTMICR)

Timer0 base: 0x4003.0000
 Timer1 base: 0x4003.1000
 Timer2 base: 0x4003.2000
 Timer3 base: 0x4003.3000
 Offset 0x024
 Type W1C, reset 0x0000.0000

	31	30	29	28	27	26	25	24	23	22	21	20	19	18	17	16
	reserved															
Type	RO	RO	RO	RO	RO	RO	RO	RO	RO	RO	RO	RO	RO	RO	RO	RO
Reset	0	0	0	0	0	0	0	0	0	0	0	0	0	0	0	0
	15	14	13	12	11	10	9	8	7	6	5	4	3	2	1	0
	reserved				CBECINT	CBMCINT	TBTOCINT	reserved				RTCCINT	CAECINT	CAMCINT	TATOCINT	
Type	RO	RO	RO	RO	RO	W1C	W1C	W1C	RO	RO	RO	RO	W1C	W1C	W1C	W1C
Reset	0	0	0	0	0	0	0	0	0	0	0	0	0	0	0	0

Bit/Field	Name	Type	Reset	Description
31:11	reserved	RO	0x00	Software should not rely on the value of a reserved bit. To provide compatibility with future products, the value of a reserved bit should be preserved across a read-modify-write operation.
10	CBECINT	W1C	0	GPTM CaptureB Event Interrupt Clear The CBECINT values are defined as follows: Value Description 0 The interrupt is unaffected. 1 The interrupt is cleared.
9	CBMCINT	W1C	0	GPTM CaptureB Match Interrupt Clear The CBMCINT values are defined as follows: Value Description 0 The interrupt is unaffected. 1 The interrupt is cleared.
8	TBTOCINT	W1C	0	GPTM TimerB Time-Out Interrupt Clear The TBTOCINT values are defined as follows: Value Description 0 The interrupt is unaffected. 1 The interrupt is cleared.
7:4	reserved	RO	0x0	Software should not rely on the value of a reserved bit. To provide compatibility with future products, the value of a reserved bit should be preserved across a read-modify-write operation.

Bit/Field	Name	Type	Reset	Description
3	RTCCINT	W1C	0	GPTM RTC Interrupt Clear The RTCCINT values are defined as follows: Value Description 0 The interrupt is unaffected. 1 The interrupt is cleared.
2	CAECINT	W1C	0	GPTM CaptureA Event Interrupt Clear The CAECINT values are defined as follows: Value Description 0 The interrupt is unaffected. 1 The interrupt is cleared.
1	CAMCINT	W1C	0	GPTM CaptureA Match Raw Interrupt This is the CaptureA match interrupt status after masking.
0	TATOCINT	W1C	0	GPTM TimerA Time-Out Raw Interrupt The TATOCINT values are defined as follows: Value Description 0 The interrupt is unaffected. 1 The interrupt is cleared.

Register 9: GPTM TimerA Interval Load (GPTMTAILR), offset 0x028

This register is used to load the starting count value into the timer. When GPTM is configured to one of the 32-bit modes, **GPTMTAILR** appears as a 32-bit register (the upper 16-bits correspond to the contents of the **GPTM TimerB Interval Load (GPTMTBILR)** register). In 16-bit mode, the upper 16 bits of this register read as 0s and have no effect on the state of **GPTMTBILR**.

GPTM TimerA Interval Load (GPTMTAILR)

Timer0 base: 0x4003.0000

Timer1 base: 0x4003.1000

Timer2 base: 0x4003.2000

Timer3 base: 0x4003.3000

Offset 0x028

Type R/W, reset 0x0000.FFFF (16-bit mode) and 0xFFFF.FFFF (32-bit mode)

	31	30	29	28	27	26	25	24	23	22	21	20	19	18	17	16
	TAILRH															
Type	R/W	R/W	R/W	R/W	R/W	R/W	R/W	R/W	R/W	R/W	R/W	R/W	R/W	R/W	R/W	R/W
Reset	0	1	1	0	1	0	1	1	1	1	0	1	1	1	1	0
	15	14	13	12	11	10	9	8	7	6	5	4	3	2	1	0
	TAILRL															
Type	R/W	R/W	R/W	R/W	R/W	R/W	R/W	R/W	R/W	R/W	R/W	R/W	R/W	R/W	R/W	R/W
Reset	1	1	1	1	1	1	1	1	1	1	1	1	1	1	1	1

Bit/Field	Name	Type	Reset	Description
31:16	TAILRH	R/W	0xFFFF (32-bit mode) 0x0000 (16-bit mode)	GPTM TimerA Interval Load Register High When configured for 32-bit mode via the GPTMCFG register, the GPTM TimerB Interval Load (GPTMTBILR) register loads this value on a write. A read returns the current value of GPTMTBILR . In 16-bit mode, this field reads as 0 and does not have an effect on the state of GPTMTBILR .
15:0	TAILRL	R/W	0xFFFF	GPTM TimerA Interval Load Register Low For both 16- and 32-bit modes, writing this field loads the counter for TimerA. A read returns the current value of GPTMTAILR .

Register 10: GPTM TimerB Interval Load (GPTMTBILR), offset 0x02C

This register is used to load the starting count value into TimerB. When the GPTM is configured to a 32-bit mode, **GPTMTBILR** returns the current value of TimerB and ignores writes.

GPTM TimerB Interval Load (GPTMTBILR)

Timer0 base: 0x4003.0000
 Timer1 base: 0x4003.1000
 Timer2 base: 0x4003.2000
 Timer3 base: 0x4003.3000
 Offset 0x02C
 Type R/W, reset 0x0000.FFFF

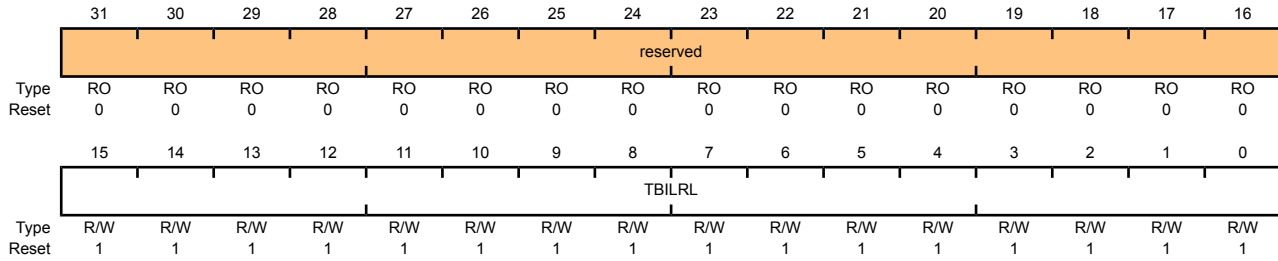

Bit/Field	Name	Type	Reset	Description
31:16	reserved	RO	0x0000	Software should not rely on the value of a reserved bit. To provide compatibility with future products, the value of a reserved bit should be preserved across a read-modify-write operation.
15:0	TBILRL	R/W	0xFFFF	GPTM TimerB Interval Load Register

When the GPTM is not configured as a 32-bit timer, a write to this field updates **GPTMTBILR**. In 32-bit mode, writes are ignored, and reads return the current value of **GPTMTBILR**.

Register 11: GPTM TimerA Match (GPTMTAMATCHR), offset 0x030

This register is used in 32-bit Real-Time Clock mode and 16-bit PWM and Input Edge Count modes.

GPTM TimerA Match (GPTMTAMATCHR)

Timer0 base: 0x4003.0000

Timer1 base: 0x4003.1000

Timer2 base: 0x4003.2000

Timer3 base: 0x4003.3000

Offset 0x030

Type R/W, reset 0x0000.FFFF (16-bit mode) and 0xFFFF.FFFF (32-bit mode)

	31	30	29	28	27	26	25	24	23	22	21	20	19	18	17	16
	TAMRH															
Type	R/W	R/W	R/W	R/W	R/W	R/W	R/W	R/W	R/W	R/W	R/W	R/W	R/W	R/W	R/W	R/W
Reset	0	1	1	0	1	0	1	1	1	1	0	1	1	1	1	0
	15	14	13	12	11	10	9	8	7	6	5	4	3	2	1	0
	TAMRL															
Type	R/W	R/W	R/W	R/W	R/W	R/W	R/W	R/W	R/W	R/W	R/W	R/W	R/W	R/W	R/W	R/W
Reset	1	1	1	1	1	1	1	1	1	1	1	1	1	1	1	1

Bit/Field	Name	Type	Reset	Description
31:16	TAMRH	R/W	0xFFFF (32-bit mode) 0x0000 (16-bit mode)	<p>GPTM TimerA Match Register High</p> <p>When configured for 32-bit Real-Time Clock (RTC) mode via the GPTMCFG register, this value is compared to the upper half of GPTMTAR, to determine match events.</p> <p>In 16-bit mode, this field reads as 0 and does not have an effect on the state of GPTMTBMATCHR.</p>
15:0	TAMRL	R/W	0xFFFF	<p>GPTM TimerA Match Register Low</p> <p>When configured for 32-bit Real-Time Clock (RTC) mode via the GPTMCFG register, this value is compared to the lower half of GPTMTAR, to determine match events.</p> <p>When configured for PWM mode, this value along with GPTMTAILR, determines the duty cycle of the output PWM signal.</p> <p>When configured for Edge Count mode, this value along with GPTMTAILR, determines how many edge events are counted. The total number of edge events counted is equal to the value in GPTMTAILR minus this value.</p>

Register 12: GPTM TimerB Match (GPTMTBMATCHR), offset 0x034

This register is used in 32-bit Real-Time Clock mode and 16-bit PWM and Input Edge Count modes.

GPTM TimerB Match (GPTMTBMATCHR)

Timer0 base: 0x4003.0000
 Timer1 base: 0x4003.1000
 Timer2 base: 0x4003.2000
 Timer3 base: 0x4003.3000
 Offset 0x034
 Type R/W, reset 0x0000.FFFF

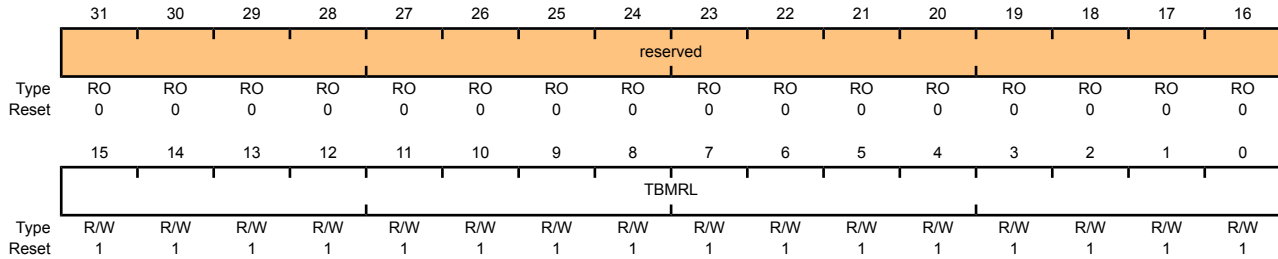

Bit/Field	Name	Type	Reset	Description
31:16	reserved	RO	0x0000	Software should not rely on the value of a reserved bit. To provide compatibility with future products, the value of a reserved bit should be preserved across a read-modify-write operation.
15:0	TBMRL	R/W	0xFFFF	GPTM TimerB Match Register Low When configured for PWM mode, this value along with GPTMTBILR , determines the duty cycle of the output PWM signal. When configured for Edge Count mode, this value along with GPTMTBILR , determines how many edge events are counted. The total number of edge events counted is equal to the value in GPTMTBILR minus this value.

Register 13: GPTM TimerA Prescale (GPTMTAPR), offset 0x038

This register allows software to extend the range of the 16-bit timers when operating in one-shot or periodic mode.

GPTM TimerA Prescale (GPTMTAPR)

Timer0 base: 0x4003.0000
 Timer1 base: 0x4003.1000
 Timer2 base: 0x4003.2000
 Timer3 base: 0x4003.3000
 Offset 0x038
 Type R/W, reset 0x0000.0000

	31	30	29	28	27	26	25	24	23	22	21	20	19	18	17	16
	reserved															
Type	RO	RO	RO	RO	RO	RO	RO	RO	RO	RO	RO	RO	RO	RO	RO	RO
Reset	0	0	0	0	0	0	0	0	0	0	0	0	0	0	0	0
	15	14	13	12	11	10	9	8	7	6	5	4	3	2	1	0
	reserved								TAPSR							
Type	RO	RO	RO	RO	RO	RO	RO	RO	R/W	R/W	R/W	R/W	R/W	R/W	R/W	R/W
Reset	0	0	0	0	0	0	0	0	0	0	0	0	0	0	0	0

Bit/Field	Name	Type	Reset	Description
31:8	reserved	RO	0x00	Software should not rely on the value of a reserved bit. To provide compatibility with future products, the value of a reserved bit should be preserved across a read-modify-write operation.
7:0	TAPSR	R/W	0x00	GPTM TimerA Prescale The register loads this value on a write. A read returns the current value of the register. Refer to Table 10-2 on page 201 for more details and an example.

Register 14: GPTM TimerB Prescale (GPTMTBPR), offset 0x03C

This register allows software to extend the range of the 16-bit timers when operating in one-shot or periodic mode.

GPTM TimerB Prescale (GPTMTBPR)

Timer0 base: 0x4003.0000
 Timer1 base: 0x4003.1000
 Timer2 base: 0x4003.2000
 Timer3 base: 0x4003.3000
 Offset 0x03C
 Type R/W, reset 0x0000.0000

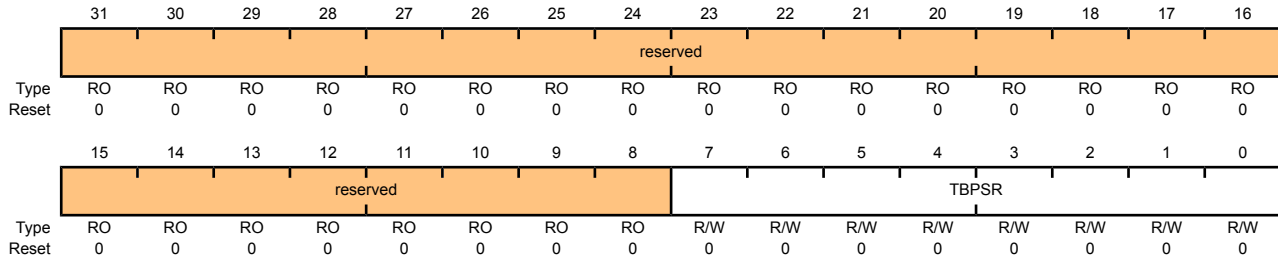

Bit/Field	Name	Type	Reset	Description
31:8	reserved	RO	0x00	Software should not rely on the value of a reserved bit. To provide compatibility with future products, the value of a reserved bit should be preserved across a read-modify-write operation.
7:0	TBPSR	R/W	0x00	GPTM TimerB Prescale The register loads this value on a write. A read returns the current value of this register. Refer to Table 10-2 on page 201 for more details and an example.

Register 15: GPTM TimerA Prescale Match (GPTMTAPMR), offset 0x040

This register effectively extends the range of **GPTMTAMATCHR** to 24 bits when operating in 16-bit one-shot or periodic mode.

GPTM TimerA Prescale Match (GPTMTAPMR)

Timer0 base: 0x4003.0000
 Timer1 base: 0x4003.1000
 Timer2 base: 0x4003.2000
 Timer3 base: 0x4003.3000
 Offset 0x040
 Type R/W, reset 0x0000.0000

	31	30	29	28	27	26	25	24	23	22	21	20	19	18	17	16
	reserved															
Type	RO	RO	RO	RO	RO	RO	RO	RO	RO	RO	RO	RO	RO	RO	RO	RO
Reset	0	0	0	0	0	0	0	0	0	0	0	0	0	0	0	0
	15	14	13	12	11	10	9	8	7	6	5	4	3	2	1	0
	reserved								TAPSMR							
Type	RO	RO	RO	RO	RO	RO	RO	RO	R/W	R/W	R/W	R/W	R/W	R/W	R/W	R/W
Reset	0	0	0	0	0	0	0	0	0	0	0	0	0	0	0	0

Bit/Field	Name	Type	Reset	Description
31:8	reserved	RO	0x00	Software should not rely on the value of a reserved bit. To provide compatibility with future products, the value of a reserved bit should be preserved across a read-modify-write operation.
7:0	TAPSMR	R/W	0x00	GPTM TimerA Prescale Match This value is used alongside GPTMTAMATCHR to detect timer match events while using a prescaler.

Register 16: GPTM TimerB Prescale Match (GPTMTBPMR), offset 0x044

This register effectively extends the range of **GPTMTBMATCHR** to 24 bits when operating in 16-bit one-shot or periodic mode.

GPTM TimerB Prescale Match (GPTMTBPMR)

Timer0 base: 0x4003.0000
 Timer1 base: 0x4003.1000
 Timer2 base: 0x4003.2000
 Timer3 base: 0x4003.3000
 Offset 0x044
 Type R/W, reset 0x0000.0000

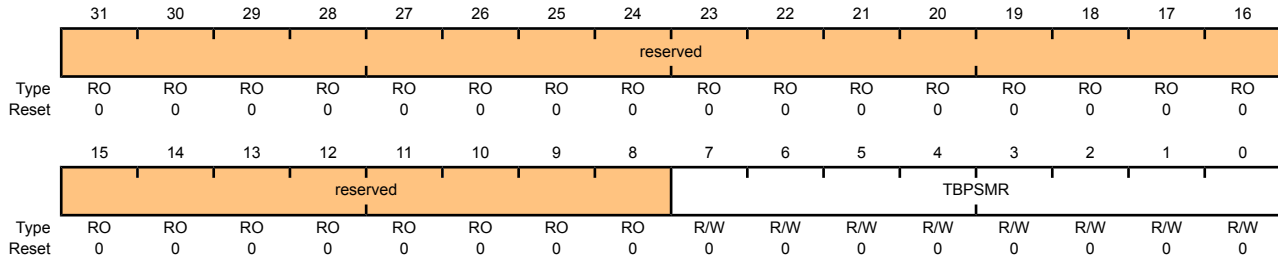

Bit/Field	Name	Type	Reset	Description
31:8	reserved	RO	0x00	Software should not rely on the value of a reserved bit. To provide compatibility with future products, the value of a reserved bit should be preserved across a read-modify-write operation.
7:0	TBPSMR	R/W	0x00	GPTM TimerB Prescale Match This value is used alongside GPTMTBMATCHR to detect timer match events while using a prescaler.

Register 17: GPTM TimerA (GPTMTAR), offset 0x048

This register shows the current value of the TimerA counter in all cases except for Input Edge Count mode. When in this mode, this register contains the time at which the last edge event took place.

GPTM TimerA (GPTMTAR)

Timer0 base: 0x4003.0000

Timer1 base: 0x4003.1000

Timer2 base: 0x4003.2000

Timer3 base: 0x4003.3000

Offset 0x048

Type RO, reset 0x0000.FFFF (16-bit mode) and 0xFFFF.FFFF (32-bit mode)

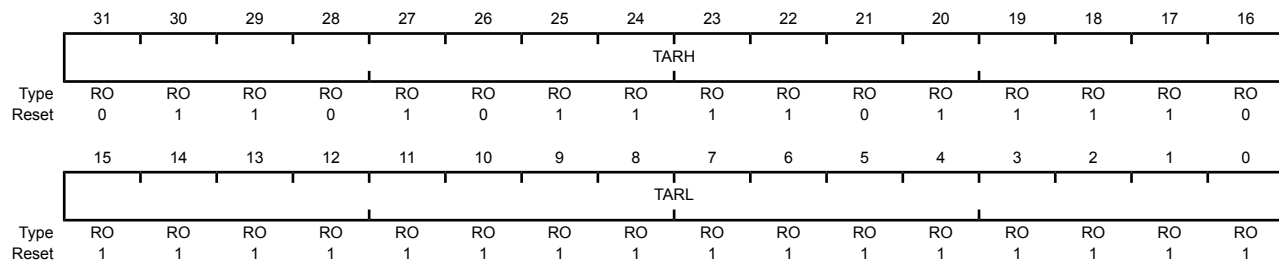

Bit/Field	Name	Type	Reset	Description
31:16	TARH	RO	0xFFFF (32-bit mode) 0x0000 (16-bit mode)	GPTM TimerA Register High If the GPTMCFG is in a 32-bit mode, TimerB value is read. If the GPTMCFG is in a 16-bit mode, this is read as zero.
15:0	TARL	RO	0xFFFF	GPTM TimerA Register Low A read returns the current value of the GPTM TimerA Count Register , except in Input Edge Count mode, when it returns the timestamp from the last edge event.

Register 18: GPTM TimerB (GPTMTBR), offset 0x04C

This register shows the current value of the TimerB counter in all cases except for Input Edge Count mode. When in this mode, this register contains the time at which the last edge event took place.

GPTM TimerB (GPTMTBR)

Timer0 base: 0x4003.0000
 Timer1 base: 0x4003.1000
 Timer2 base: 0x4003.2000
 Timer3 base: 0x4003.3000
 Offset 0x04C
 Type RO, reset 0x0000.FFFF

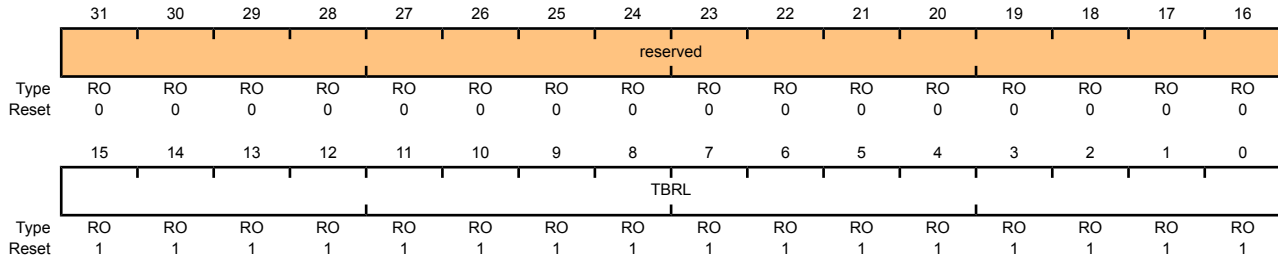

Bit/Field	Name	Type	Reset	Description
31:16	reserved	RO	0x0000	Software should not rely on the value of a reserved bit. To provide compatibility with future products, the value of a reserved bit should be preserved across a read-modify-write operation.
15:0	TBRL	RO	0xFFFF	GPTM TimerB

A read returns the current value of the **GPTM TimerB Count Register**, except in Input Edge Count mode, when it returns the timestamp from the last edge event.

11 Watchdog Timer

A watchdog timer can generate nonmaskable interrupts (NMIs) or a reset when a time-out value is reached. The watchdog timer is used to regain control when a system has failed due to a software error or due to the failure of an external device to respond in the expected way.

The Stellaris[®] Watchdog Timer module consists of a 32-bit down counter, a programmable load register, interrupt generation logic, a locking register, and user-enabled stalling.

The Watchdog Timer can be configured to generate an interrupt to the controller on its first time-out, and to generate a reset signal on its second time-out. Once the Watchdog Timer has been configured, the lock register can be written to prevent the timer configuration from being inadvertently altered.

11.1 Block Diagram

Figure 11-1. WDT Module Block Diagram

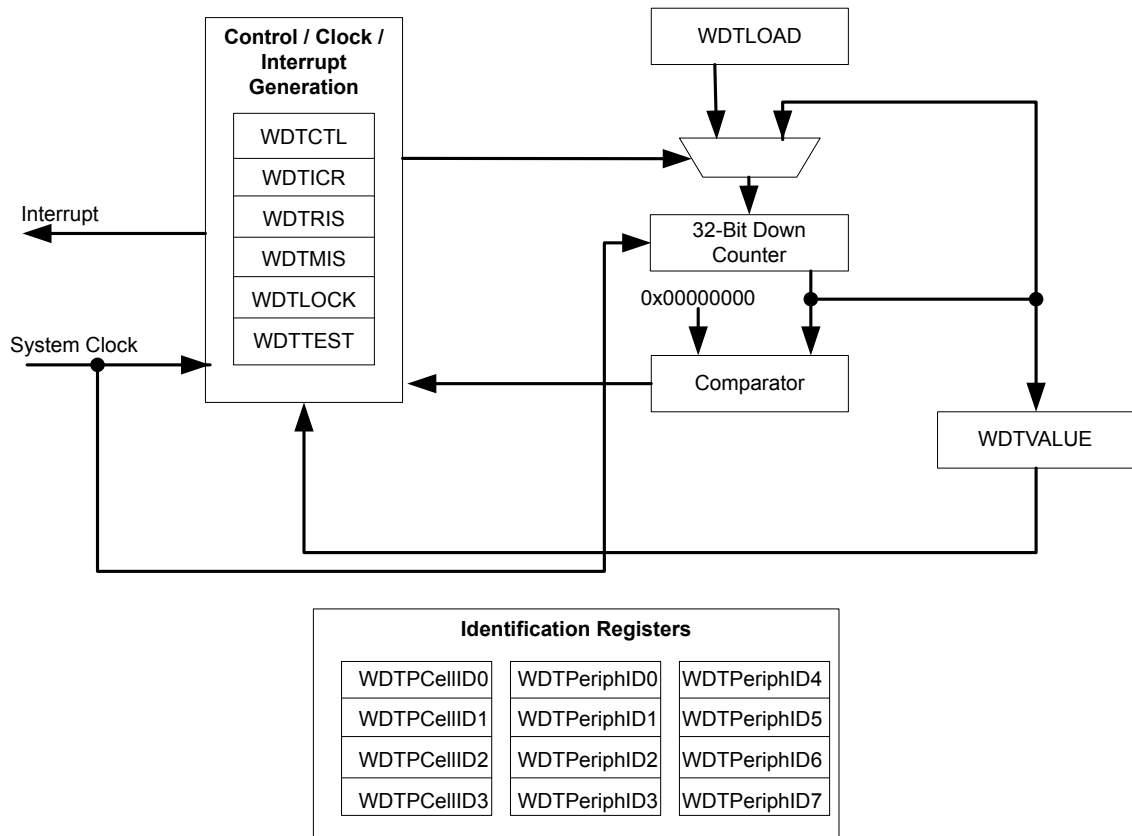

11.2 Functional Description

The Watchdog Timer module generates the first time-out signal when the 32-bit counter reaches the zero state after being enabled; enabling the counter also enables the watchdog timer interrupt. After the first time-out event, the 32-bit counter is re-loaded with the value of the **Watchdog Timer Load (WDTLOAD)** register, and the timer resumes counting down from that value. Once the

Watchdog Timer has been configured, the **Watchdog Timer Lock (WDTLOCK)** register is written, which prevents the timer configuration from being inadvertently altered by software.

If the timer counts down to its zero state again before the first time-out interrupt is cleared, and the reset signal has been enabled (via the `WatchdogResetEnable` function), the Watchdog timer asserts its reset signal to the system. If the interrupt is cleared before the 32-bit counter reaches its second time-out, the 32-bit counter is loaded with the value in the **WDTLOAD** register, and counting resumes from that value.

If **WDTLOAD** is written with a new value while the Watchdog Timer counter is counting, then the counter is loaded with the new value and continues counting.

Writing to **WDTLOAD** does not clear an active interrupt. An interrupt must be specifically cleared by writing to the **Watchdog Interrupt Clear (WDTICR)** register.

The Watchdog module interrupt and reset generation can be enabled or disabled as required. When the interrupt is re-enabled, the 32-bit counter is preloaded with the load register value and not its last state.

11.3 Initialization and Configuration

To use the WDT, its peripheral clock must be enabled by setting the `WDT` bit in the **RCGC0** register. The Watchdog Timer is configured using the following sequence:

1. Load the **WDTLOAD** register with the desired timer load value.
2. If the Watchdog is configured to trigger system resets, set the `RESEN` bit in the **WDTCTL** register.
3. Set the `INTEN` bit in the **WDTCTL** register to enable the Watchdog and lock the control register.

If software requires that all of the watchdog registers are locked, the Watchdog Timer module can be fully locked by writing any value to the **WDTLOCK** register. To unlock the Watchdog Timer, write a value of `0x1ACC.E551`.

11.4 Register Map

Table 11-1 on page 234 lists the Watchdog registers. The offset listed is a hexadecimal increment to the register's address, relative to the Watchdog Timer base address of `0x4000.0000`.

Table 11-1. Watchdog Timer Register Map

Offset	Name	Type	Reset	Description	See page
0x000	WDTLOAD	R/W	0xFFFF.FFFF	Watchdog Load	236
0x004	WDTVALUE	RO	0xFFFF.FFFF	Watchdog Value	237
0x008	WDTCTL	R/W	0x0000.0000	Watchdog Control	238
0x00C	WDTICR	WO	-	Watchdog Interrupt Clear	239
0x010	WDTRIS	RO	0x0000.0000	Watchdog Raw Interrupt Status	240
0x014	WDTMIS	RO	0x0000.0000	Watchdog Masked Interrupt Status	241
0x418	WDTTEST	R/W	0x0000.0000	Watchdog Test	242
0xC00	WDTLOCK	R/W	0x0000.0000	Watchdog Lock	243

Offset	Name	Type	Reset	Description	See page
0xFD0	WDTPeriphID4	RO	0x0000.0000	Watchdog Peripheral Identification 4	244
0xFD4	WDTPeriphID5	RO	0x0000.0000	Watchdog Peripheral Identification 5	245
0xFD8	WDTPeriphID6	RO	0x0000.0000	Watchdog Peripheral Identification 6	246
0xFDC	WDTPeriphID7	RO	0x0000.0000	Watchdog Peripheral Identification 7	247
0xFE0	WDTPeriphID0	RO	0x0000.0005	Watchdog Peripheral Identification 0	248
0xFE4	WDTPeriphID1	RO	0x0000.0018	Watchdog Peripheral Identification 1	249
0xFE8	WDTPeriphID2	RO	0x0000.0018	Watchdog Peripheral Identification 2	250
0xFEC	WDTPeriphID3	RO	0x0000.0001	Watchdog Peripheral Identification 3	251
0xFF0	WDTPCellID0	RO	0x0000.000D	Watchdog PrimeCell Identification 0	252
0xFF4	WDTPCellID1	RO	0x0000.00F0	Watchdog PrimeCell Identification 1	253
0xFF8	WDTPCellID2	RO	0x0000.0005	Watchdog PrimeCell Identification 2	254
0xFFC	WDTPCellID3	RO	0x0000.00B1	Watchdog PrimeCell Identification 3	255

11.5 Register Descriptions

The remainder of this section lists and describes the WDT registers, in numerical order by address offset.

Register 1: Watchdog Load (WDTLOAD), offset 0x000

This register is the 32-bit interval value used by the 32-bit counter. When this register is written, the value is immediately loaded and the counter restarts counting down from the new value. If the **WDTLOAD** register is loaded with 0x0000.0000, an interrupt is immediately generated.

Watchdog Load (WDTLOAD)

Base 0x4000.0000

Offset 0x000

Type R/W, reset 0xFFFF.FFFF

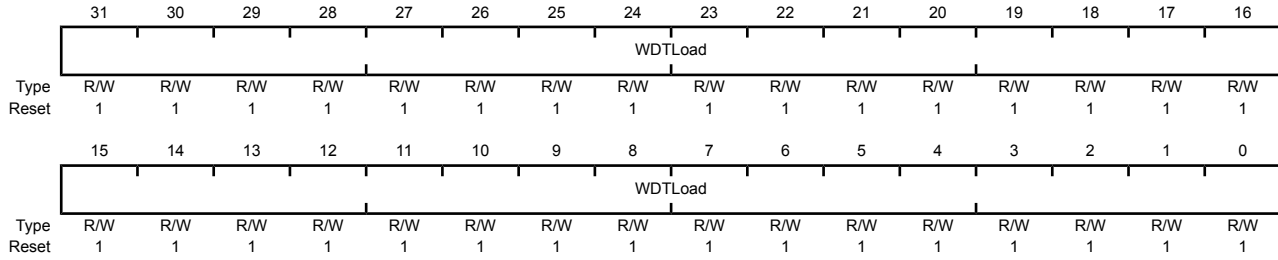

Bit/Field	Name	Type	Reset	Description
31:0	WDTLoad	R/W	0xFFFF.FFFF	Watchdog Load Value

Register 2: Watchdog Value (WDTVALUE), offset 0x004

This register contains the current count value of the timer.

Watchdog Value (WDTVALUE)

Base 0x4000.0000

Offset 0x004

Type RO, reset 0xFFFF.FFFF

	31	30	29	28	27	26	25	24	23	22	21	20	19	18	17	16
	WDTValue															
Type	RO	RO	RO	RO	RO	RO	RO	RO	RO	RO	RO	RO	RO	RO	RO	RO
Reset	1	1	1	1	1	1	1	1	1	1	1	1	1	1	1	1
	15	14	13	12	11	10	9	8	7	6	5	4	3	2	1	0
	WDTValue															
Type	RO	RO	RO	RO	RO	RO	RO	RO	RO	RO	RO	RO	RO	RO	RO	RO
Reset	1	1	1	1	1	1	1	1	1	1	1	1	1	1	1	1

Bit/Field	Name	Type	Reset	Description
31:0	WDTValue	RO	0xFFFF.FFFF	Watchdog Value Current value of the 32-bit down counter.

Register 3: Watchdog Control (WDTCTL), offset 0x008

This register is the watchdog control register. The watchdog timer can be configured to generate a reset signal (on second time-out) or an interrupt on time-out.

When the watchdog interrupt has been enabled, all subsequent writes to the control register are ignored. The only mechanism that can re-enable writes is a hardware reset.

Watchdog Control (WDTCTL)

Base 0x4000.0000
 Offset 0x008
 Type R/W, reset 0x0000.0000

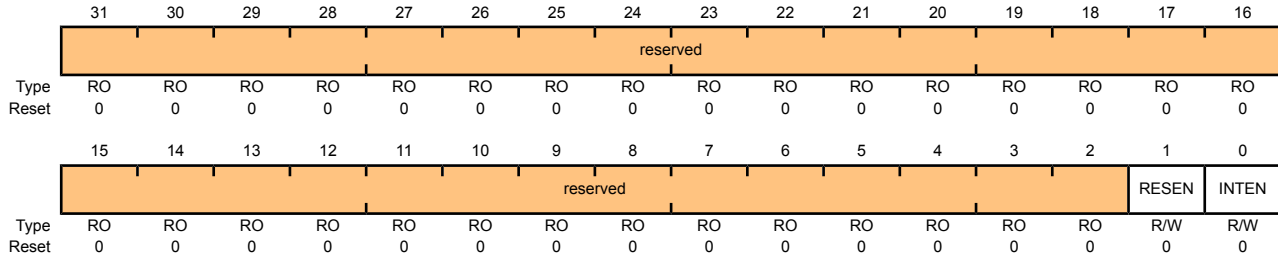

Bit/Field	Name	Type	Reset	Description						
31:2	reserved	RO	0x00	Software should not rely on the value of a reserved bit. To provide compatibility with future products, the value of a reserved bit should be preserved across a read-modify-write operation.						
1	RESEN	R/W	0	Watchdog Reset Enable The RESEN values are defined as follows: <table border="1"> <thead> <tr> <th>Value</th> <th>Description</th> </tr> </thead> <tbody> <tr> <td>0</td> <td>Disabled.</td> </tr> <tr> <td>1</td> <td>Enable the Watchdog module reset output.</td> </tr> </tbody> </table>	Value	Description	0	Disabled.	1	Enable the Watchdog module reset output.
Value	Description									
0	Disabled.									
1	Enable the Watchdog module reset output.									
0	INTEN	R/W	0	Watchdog Interrupt Enable The INTEN values are defined as follows: <table border="1"> <thead> <tr> <th>Value</th> <th>Description</th> </tr> </thead> <tbody> <tr> <td>0</td> <td>Interrupt event disabled (once this bit is set, it can only be cleared by a hardware reset).</td> </tr> <tr> <td>1</td> <td>Interrupt event enabled. Once enabled, all writes are ignored.</td> </tr> </tbody> </table>	Value	Description	0	Interrupt event disabled (once this bit is set, it can only be cleared by a hardware reset).	1	Interrupt event enabled. Once enabled, all writes are ignored.
Value	Description									
0	Interrupt event disabled (once this bit is set, it can only be cleared by a hardware reset).									
1	Interrupt event enabled. Once enabled, all writes are ignored.									

Register 4: Watchdog Interrupt Clear (WDTICR), offset 0x00C

This register is the interrupt clear register. A write of any value to this register clears the Watchdog interrupt and reloads the 32-bit counter from the **WDTLOAD** register. Value for a read or reset is indeterminate.

Watchdog Interrupt Clear (WDTICR)

Base 0x4000.0000

Offset 0x00C

Type WO, reset -

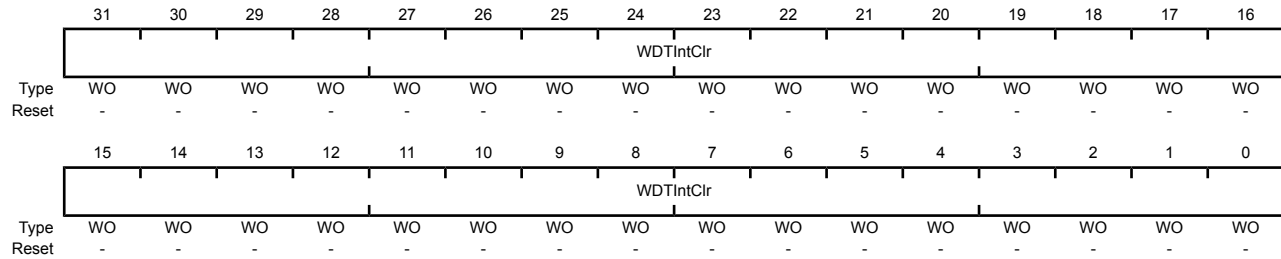

Bit/Field	Name	Type	Reset	Description
31:0	WDTIntClr	WO	-	Watchdog Interrupt Clear

Register 5: Watchdog Raw Interrupt Status (WDTRIS), offset 0x010

This register is the raw interrupt status register. Watchdog interrupt events can be monitored via this register if the controller interrupt is masked.

Watchdog Raw Interrupt Status (WDTRIS)

Base 0x4000.0000
 Offset 0x010
 Type RO, reset 0x0000.0000

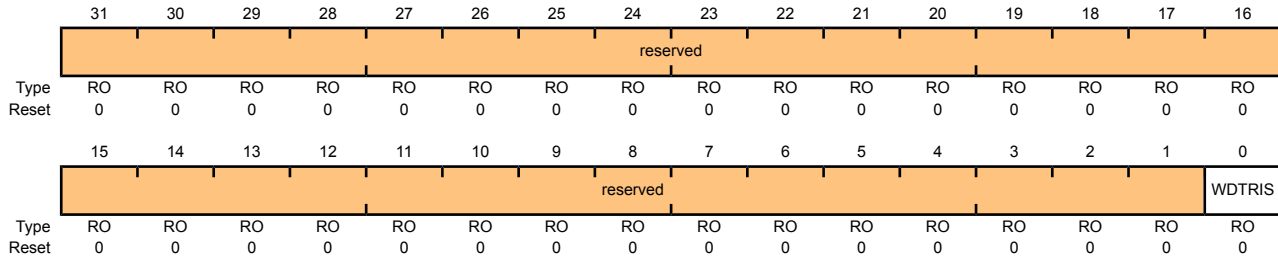

Bit/Field	Name	Type	Reset	Description
31:1	reserved	RO	0x00	Software should not rely on the value of a reserved bit. To provide compatibility with future products, the value of a reserved bit should be preserved across a read-modify-write operation.
0	WDTRIS	RO	0	Watchdog Raw Interrupt Status Gives the raw interrupt state (prior to masking) of WDTINTR .

Register 6: Watchdog Masked Interrupt Status (WDTMIS), offset 0x014

This register is the masked interrupt status register. The value of this register is the logical AND of the raw interrupt bit and the Watchdog interrupt enable bit.

Watchdog Masked Interrupt Status (WDTMIS)

Base 0x4000.0000

Offset 0x014

Type RO, reset 0x0000.0000

	31	30	29	28	27	26	25	24	23	22	21	20	19	18	17	16
	reserved															
Type	RO	RO	RO	RO	RO	RO	RO	RO	RO	RO	RO	RO	RO	RO	RO	RO
Reset	0	0	0	0	0	0	0	0	0	0	0	0	0	0	0	0
	15	14	13	12	11	10	9	8	7	6	5	4	3	2	1	0
	reserved															WDTMIS
Type	RO	RO	RO	RO	RO	RO	RO	RO	RO	RO	RO	RO	RO	RO	RO	RO
Reset	0	0	0	0	0	0	0	0	0	0	0	0	0	0	0	0

Bit/Field	Name	Type	Reset	Description
31:1	reserved	RO	0x00	Software should not rely on the value of a reserved bit. To provide compatibility with future products, the value of a reserved bit should be preserved across a read-modify-write operation.
0	WDTMIS	RO	0	Watchdog Masked Interrupt Status Gives the masked interrupt state (after masking) of the WDTINTR interrupt.

Register 7: Watchdog Test (WDTTEST), offset 0x418

This register provides user-enabled stalling when the microcontroller asserts the CPU halt flag during debug.

Watchdog Test (WDTTEST)

Base 0x4000.0000
 Offset 0x418
 Type R/W, reset 0x0000.0000

	31	30	29	28	27	26	25	24	23	22	21	20	19	18	17	16
	reserved															
Type	RO	RO	RO	RO	RO	RO	RO	RO	RO	RO	RO	RO	RO	RO	RO	RO
Reset	0	0	0	0	0	0	0	0	0	0	0	0	0	0	0	0
	15	14	13	12	11	10	9	8	7	6	5	4	3	2	1	0
	reserved							STALL	reserved							
Type	RO	RO	RO	RO	RO	RO	RO	R/W	RO	RO	RO	RO	RO	RO	RO	RO
Reset	0	0	0	0	0	0	0	0	0	0	0	0	0	0	0	0

Bit/Field	Name	Type	Reset	Description
31:9	reserved	RO	0x00	Software should not rely on the value of a reserved bit. To provide compatibility with future products, the value of a reserved bit should be preserved across a read-modify-write operation.
8	STALL	R/W	0	Watchdog Stall Enable When set to 1, if the Stellaris® microcontroller is stopped with a debugger, the watchdog timer stops counting. Once the microcontroller is restarted, the watchdog timer resumes counting.
7:0	reserved	RO	0x00	Software should not rely on the value of a reserved bit. To provide compatibility with future products, the value of a reserved bit should be preserved across a read-modify-write operation.

Register 8: Watchdog Lock (WDTLOCK), offset 0xC00

Writing 0x1ACC.E551 to the **WDTLOCK** register enables write access to all other registers. Writing any other value to the **WDTLOCK** register re-enables the locked state for register writes to all the other registers. Reading the **WDTLOCK** register returns the lock status rather than the 32-bit value written. Therefore, when write accesses are disabled, reading the **WDTLOCK** register returns 0x0000.0001 (when locked; otherwise, the returned value is 0x0000.0000 (unlocked)).

Watchdog Lock (WDTLOCK)

Base 0x4000.0000
Offset 0xC00
Type R/W, reset 0x0000.0000

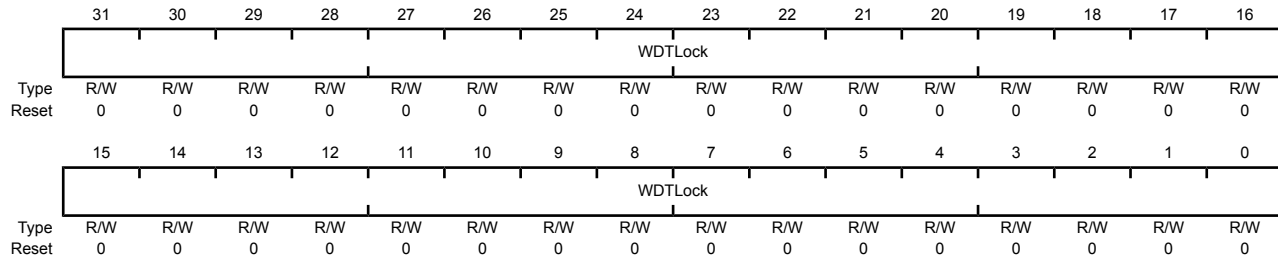

Bit/Field	Name	Type	Reset	Description
31:0	WDTLock	R/W	0x0000	Watchdog Lock

A write of the value 0x1ACC.E551 unlocks the watchdog registers for write access. A write of any other value reapplies the lock, preventing any register updates.

A read of this register returns the following values:

Value	Description
0x0000.0001	Locked
0x0000.0000	Unlocked

Register 9: Watchdog Peripheral Identification 4 (WDTPeriphID4), offset 0xFD0

The **WDTPeriphIDn** registers are hard-coded and the fields within the register determine the reset value.

Watchdog Peripheral Identification 4 (WDTPeriphID4)

Base 0x4000.0000
 Offset 0xFD0
 Type RO, reset 0x0000.0000

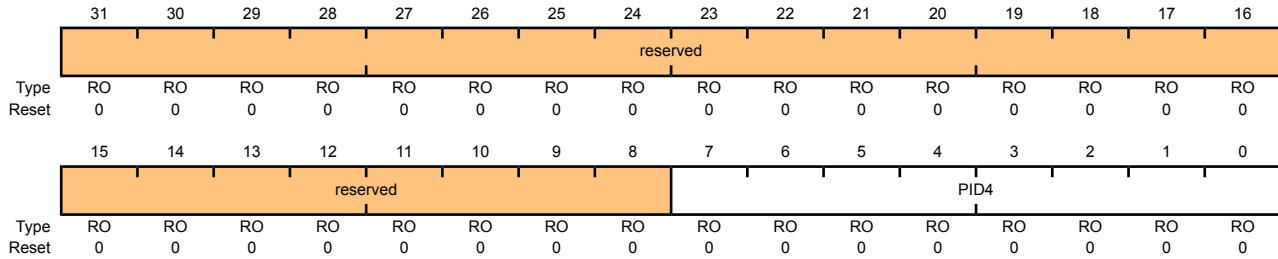

Bit/Field	Name	Type	Reset	Description
31:8	reserved	RO	0x00	Software should not rely on the value of a reserved bit. To provide compatibility with future products, the value of a reserved bit should be preserved across a read-modify-write operation.
7:0	PID4	RO	0x00	WDT Peripheral ID Register[7:0]

Register 10: Watchdog Peripheral Identification 5 (WDTPeriphID5), offset 0xFD4

The **WDTPeriphIDn** registers are hard-coded and the fields within the register determine the reset value.

Watchdog Peripheral Identification 5 (WDTPeriphID5)

Base 0x4000.0000

Offset 0xFD4

Type RO, reset 0x0000.0000

	31	30	29	28	27	26	25	24	23	22	21	20	19	18	17	16
	reserved															
Type	RO	RO	RO	RO	RO	RO	RO	RO	RO	RO	RO	RO	RO	RO	RO	RO
Reset	0	0	0	0	0	0	0	0	0	0	0	0	0	0	0	0
	15	14	13	12	11	10	9	8	7	6	5	4	3	2	1	0
	reserved								PID5							
Type	RO	RO	RO	RO	RO	RO	RO	RO	RO	RO	RO	RO	RO	RO	RO	RO
Reset	0	0	0	0	0	0	0	0	0	0	0	0	0	0	0	0

Bit/Field	Name	Type	Reset	Description
31:8	reserved	RO	0x00	Software should not rely on the value of a reserved bit. To provide compatibility with future products, the value of a reserved bit should be preserved across a read-modify-write operation.
7:0	PID5	RO	0x00	WDT Peripheral ID Register[15:8]

Register 11: Watchdog Peripheral Identification 6 (WDTPeriphID6), offset 0xFD8

The **WDTPeriphIDn** registers are hard-coded and the fields within the register determine the reset value.

Watchdog Peripheral Identification 6 (WDTPeriphID6)

Base 0x4000.0000
 Offset 0xFD8
 Type RO, reset 0x0000.0000

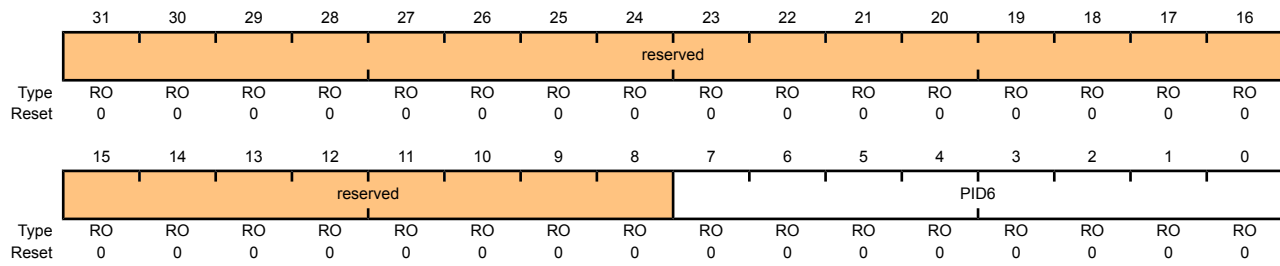

Bit/Field	Name	Type	Reset	Description
31:8	reserved	RO	0x00	Software should not rely on the value of a reserved bit. To provide compatibility with future products, the value of a reserved bit should be preserved across a read-modify-write operation.
7:0	PID6	RO	0x00	WDT Peripheral ID Register[23:16]

Register 12: Watchdog Peripheral Identification 7 (WDTPeriphID7), offset 0xFDC

The **WDTPeriphIDn** registers are hard-coded and the fields within the register determine the reset value.

Watchdog Peripheral Identification 7 (WDTPeriphID7)

Base 0x4000.0000

Offset 0xFDC

Type RO, reset 0x0000.0000

	31	30	29	28	27	26	25	24	23	22	21	20	19	18	17	16
	reserved															
Type	RO	RO	RO	RO	RO	RO	RO	RO	RO	RO	RO	RO	RO	RO	RO	RO
Reset	0	0	0	0	0	0	0	0	0	0	0	0	0	0	0	0
	15	14	13	12	11	10	9	8	7	6	5	4	3	2	1	0
	reserved								PID7							
Type	RO	RO	RO	RO	RO	RO	RO	RO	RO	RO	RO	RO	RO	RO	RO	RO
Reset	0	0	0	0	0	0	0	0	0	0	0	0	0	0	0	0

Bit/Field	Name	Type	Reset	Description
31:8	reserved	RO	0x00	Software should not rely on the value of a reserved bit. To provide compatibility with future products, the value of a reserved bit should be preserved across a read-modify-write operation.
7:0	PID7	RO	0x00	WDT Peripheral ID Register[31:24]

Register 13: Watchdog Peripheral Identification 0 (WDTPeriphID0), offset 0xFE0

The **WDTPeriphIDn** registers are hard-coded and the fields within the register determine the reset value.

Watchdog Peripheral Identification 0 (WDTPeriphID0)

Base 0x4000.0000
 Offset 0xFE0
 Type RO, reset 0x0000.0005

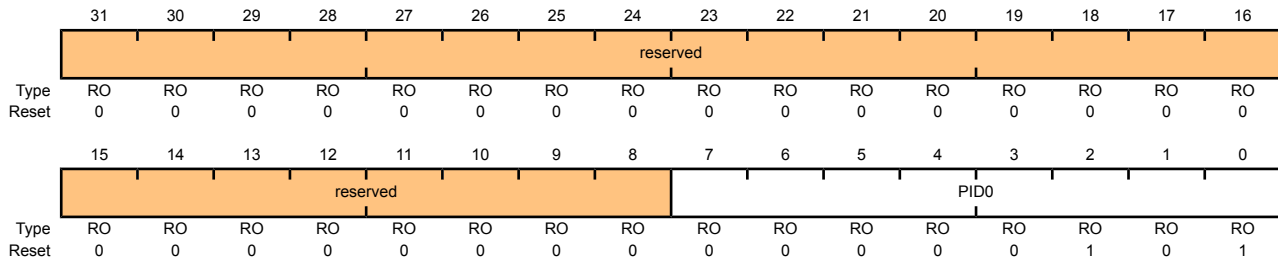

Bit/Field	Name	Type	Reset	Description
31:8	reserved	RO	0x00	Software should not rely on the value of a reserved bit. To provide compatibility with future products, the value of a reserved bit should be preserved across a read-modify-write operation.
7:0	PID0	RO	0x05	Watchdog Peripheral ID Register[7:0]

Register 14: Watchdog Peripheral Identification 1 (WDTPeriphID1), offset 0xFE4

The **WDTPeriphIDn** registers are hard-coded and the fields within the register determine the reset value.

Watchdog Peripheral Identification 1 (WDTPeriphID1)

Base 0x4000.0000

Offset 0xFE4

Type RO, reset 0x0000.0018

	31	30	29	28	27	26	25	24	23	22	21	20	19	18	17	16
	reserved															
Type	RO	RO	RO	RO	RO	RO	RO	RO	RO	RO	RO	RO	RO	RO	RO	RO
Reset	0	0	0	0	0	0	0	0	0	0	0	0	0	0	0	0
	15	14	13	12	11	10	9	8	7	6	5	4	3	2	1	0
	reserved								PID1							
Type	RO	RO	RO	RO	RO	RO	RO	RO	RO	RO	RO	RO	RO	RO	RO	RO
Reset	0	0	0	0	0	0	0	0	0	0	0	1	1	0	0	0

Bit/Field	Name	Type	Reset	Description
31:8	reserved	RO	0x00	Software should not rely on the value of a reserved bit. To provide compatibility with future products, the value of a reserved bit should be preserved across a read-modify-write operation.
7:0	PID1	RO	0x18	Watchdog Peripheral ID Register[15:8]

Register 15: Watchdog Peripheral Identification 2 (WDTPeriphID2), offset 0xFE8

The **WDTPeriphIDn** registers are hard-coded and the fields within the register determine the reset value.

Watchdog Peripheral Identification 2 (WDTPeriphID2)

Base 0x4000.0000
 Offset 0xFE8
 Type RO, reset 0x0000.0018

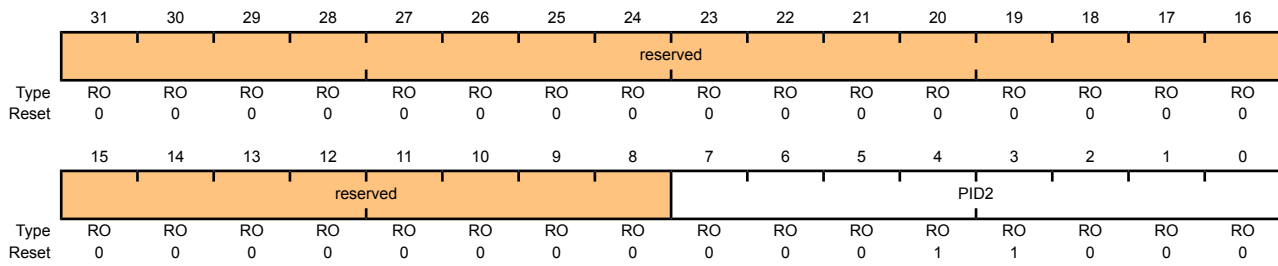

Bit/Field	Name	Type	Reset	Description
31:8	reserved	RO	0x00	Software should not rely on the value of a reserved bit. To provide compatibility with future products, the value of a reserved bit should be preserved across a read-modify-write operation.
7:0	PID2	RO	0x18	Watchdog Peripheral ID Register[23:16]

Register 16: Watchdog Peripheral Identification 3 (WDTPeriphID3), offset 0xFEC

The **WDTPeriphIDn** registers are hard-coded and the fields within the register determine the reset value.

Watchdog Peripheral Identification 3 (WDTPeriphID3)

Base 0x4000.0000

Offset 0xFEC

Type RO, reset 0x0000.0001

	31	30	29	28	27	26	25	24	23	22	21	20	19	18	17	16
	reserved															
Type	RO	RO	RO	RO	RO	RO	RO	RO	RO	RO	RO	RO	RO	RO	RO	RO
Reset	0	0	0	0	0	0	0	0	0	0	0	0	0	0	0	0
	15	14	13	12	11	10	9	8	7	6	5	4	3	2	1	0
	reserved								PID3							
Type	RO	RO	RO	RO	RO	RO	RO	RO	RO	RO	RO	RO	RO	RO	RO	RO
Reset	0	0	0	0	0	0	0	0	0	0	0	0	0	0	0	1

Bit/Field	Name	Type	Reset	Description
31:8	reserved	RO	0x00	Software should not rely on the value of a reserved bit. To provide compatibility with future products, the value of a reserved bit should be preserved across a read-modify-write operation.
7:0	PID3	RO	0x01	Watchdog Peripheral ID Register[31:24]

Register 17: Watchdog PrimeCell Identification 0 (WDTPCellID0), offset 0xFF0

The **WDTPCellIDn** registers are hard-coded and the fields within the register determine the reset value.

Watchdog PrimeCell Identification 0 (WDTPCellID0)

Base 0x4000.0000
 Offset 0xFF0
 Type RO, reset 0x0000.000D

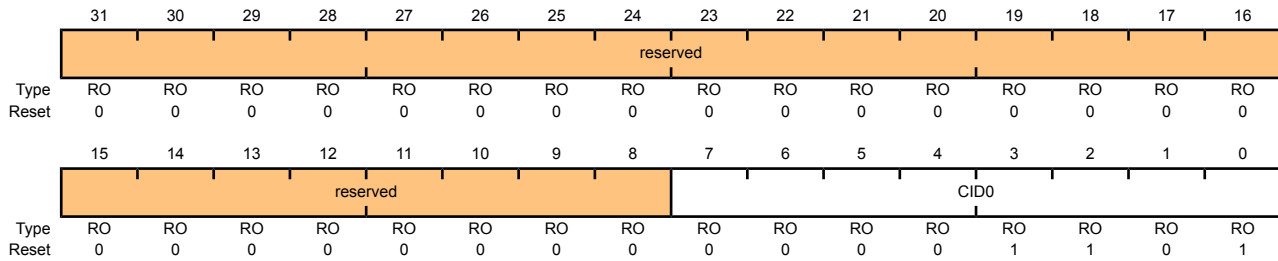

Bit/Field	Name	Type	Reset	Description
31:8	reserved	RO	0x00	Software should not rely on the value of a reserved bit. To provide compatibility with future products, the value of a reserved bit should be preserved across a read-modify-write operation.
7:0	CID0	RO	0x0D	Watchdog PrimeCell ID Register[7:0]

Register 18: Watchdog PrimeCell Identification 1 (WDTPCellID1), offset 0xFF4

The **WDTPCellIDn** registers are hard-coded and the fields within the register determine the reset value.

Watchdog PrimeCell Identification 1 (WDTPCellID1)

Base 0x4000.0000

Offset 0xFF4

Type RO, reset 0x0000.00F0

	31	30	29	28	27	26	25	24	23	22	21	20	19	18	17	16
	reserved															
Type	RO	RO	RO	RO	RO	RO	RO	RO	RO	RO	RO	RO	RO	RO	RO	RO
Reset	0	0	0	0	0	0	0	0	0	0	0	0	0	0	0	0
	15	14	13	12	11	10	9	8	7	6	5	4	3	2	1	0
	reserved								CID1							
Type	RO	RO	RO	RO	RO	RO	RO	RO	RO	RO	RO	RO	RO	RO	RO	RO
Reset	0	0	0	0	0	0	0	0	1	1	1	1	0	0	0	0

Bit/Field	Name	Type	Reset	Description
31:8	reserved	RO	0x00	Software should not rely on the value of a reserved bit. To provide compatibility with future products, the value of a reserved bit should be preserved across a read-modify-write operation.
7:0	CID1	RO	0xF0	Watchdog PrimeCell ID Register[15:8]

Register 19: Watchdog PrimeCell Identification 2 (WDTPCellID2), offset 0xFF8

The **WDTPCellIDn** registers are hard-coded and the fields within the register determine the reset value.

Watchdog PrimeCell Identification 2 (WDTPCellID2)

Base 0x4000.0000
 Offset 0xFF8
 Type RO, reset 0x0000.0005

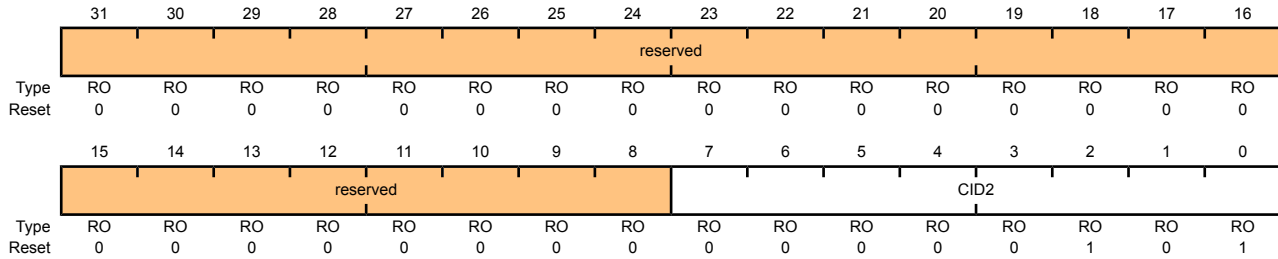

Bit/Field	Name	Type	Reset	Description
31:8	reserved	RO	0x00	Software should not rely on the value of a reserved bit. To provide compatibility with future products, the value of a reserved bit should be preserved across a read-modify-write operation.
7:0	CID2	RO	0x05	Watchdog PrimeCell ID Register[23:16]

Register 20: Watchdog PrimeCell Identification 3 (WDTPCellID3), offset 0xFFC

The **WDTPCellIDn** registers are hard-coded and the fields within the register determine the reset value.

Watchdog PrimeCell Identification 3 (WDTPCellID3)

Base 0x4000.0000

Offset 0xFFC

Type RO, reset 0x0000.00B1

	31	30	29	28	27	26	25	24	23	22	21	20	19	18	17	16
	reserved															
Type	RO	RO	RO	RO	RO	RO	RO	RO	RO	RO	RO	RO	RO	RO	RO	RO
Reset	0	0	0	0	0	0	0	0	0	0	0	0	0	0	0	0
	15	14	13	12	11	10	9	8	7	6	5	4	3	2	1	0
	reserved								CID3							
Type	RO	RO	RO	RO	RO	RO	RO	RO	RO	RO	RO	RO	RO	RO	RO	RO
Reset	0	0	0	0	0	0	0	0	1	0	1	1	0	0	0	1

Bit/Field	Name	Type	Reset	Description
31:8	reserved	RO	0x00	Software should not rely on the value of a reserved bit. To provide compatibility with future products, the value of a reserved bit should be preserved across a read-modify-write operation.
7:0	CID3	RO	0xB1	Watchdog PrimeCell ID Register[31:24]

12 Analog-to-Digital Converter (ADC)

An analog-to-digital converter (ADC) is a peripheral that converts a continuous analog voltage to a discrete digital number.

The Stellaris[®] ADC module features 10-bit conversion resolution and supports six input channels. The ADC module contains a programmable sequencer which allows for the sampling of multiple analog input sources without controller intervention. Each sample sequence provides flexible programming with fully configurable input source, trigger events, interrupt generation, and sequence priority.

The Stellaris[®] ADC provides the following features:

- Six analog input channels
- Single-ended and differential-input configurations
- Sample rate of 500 thousand samples/second
- Four programmable sample conversion sequences from one to eight entries long, with corresponding conversion result FIFOs
- Flexible trigger control
 - Controller (software)
 - Timers
 - PWM
 - GPIO
- Hardware averaging of up to 64 samples for improved accuracy

12.1 Block Diagram

Figure 12-1. ADC Module Block Diagram

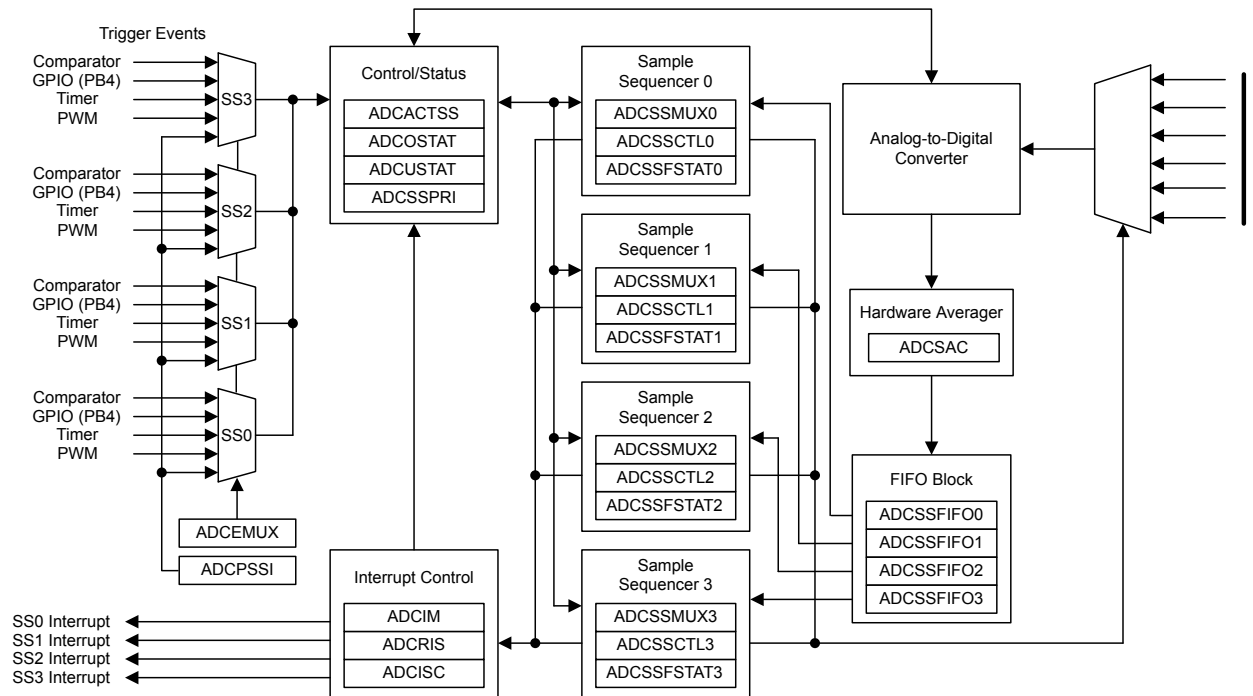

12.2 Functional Description

The Stellaris[®] ADC collects sample data by using a programmable sequence-based approach instead of the traditional single or double-sampling approach found on many ADC modules. Each *sample sequence* is a fully programmed series of consecutive (back-to-back) samples, allowing the ADC to collect data from multiple input sources without having to be re-configured or serviced by the controller. The programming of each sample in the sample sequence includes parameters such as the input source and mode (differential versus single-ended input), interrupt generation on sample completion, and the indicator for the last sample in the sequence.

12.2.1 Sample Sequencers

The sampling control and data capture is handled by the Sample Sequencers. All of the sequencers are identical in implementation except for the number of samples that can be captured and the depth of the FIFO. Table 12-1 on page 257 shows the maximum number of samples that each Sequencer can capture and its corresponding FIFO depth. In this implementation, each FIFO entry is a 32-bit word, with the lower 10 bits containing the conversion result.

Table 12-1. Samples and FIFO Depth of Sequencers

Sequencer	Number of Samples	Depth of FIFO
SS3	1	1
SS2	4	4
SS1	4	4
SS0	8	8

For a given sample sequence, each sample is defined by two 4-bit nibbles in the **ADC Sample Sequence Input Multiplexer Select (ADCSSMUXn)** and **ADC Sample Sequence Control (ADCSSCTLn)** registers, where "n" corresponds to the sequence number. The **ADCSSMUXn** nibbles select the input pin, while the **ADCSSCTLn** nibbles contain the sample control bits corresponding to parameters such as interrupt enable, end of sequence, and differential input mode. Sample Sequencers are enabled by setting the respective **ASENn** bit in the **ADC Active Sample Sequencer (ADCACTSS)** register, but can be configured before being enabled.

When configuring a sample sequence, multiple uses of the same input pin within the same sequence is allowed. In the **ADCSSCTLn** register, the **Interrupt Enable (IE)** bits can be set for any combination of samples, allowing interrupts to be generated after every sample in the sequence if necessary. Also, the **END** bit can be set at any point within a sample sequence. For example, if Sequencer 0 is used, the **END** bit can be set in the nibble associated with the fifth sample, allowing Sequencer 0 to complete execution of the sample sequence after the fifth sample.

After a sample sequence completes execution, the result data can be retrieved from the **ADC Sample Sequence Result FIFO (ADCSSFIFO)** registers. The FIFOs are simple circular buffers that read a single address to "pop" result data. For software debug purposes, the positions of the FIFO head and tail pointers are visible in the **ADC Sample Sequence FIFO Status (ADCSSFSTATn)** registers along with **FULL** and **EMPTY** status flags. Overflow and underflow conditions are monitored using the **ADCSTAT** and **ADCUSTAT** registers.

12.2.2 Module Control

Outside of the Sample Sequencers, the remainder of the control logic is responsible for tasks such as interrupt generation, sequence prioritization, and trigger configuration.

Most of the ADC control logic runs at the ADC clock rate of 14-18 MHz. The internal ADC divider is configured automatically by hardware when the system **XTAL** is selected. The automatic clock divider configuration targets 16.667 MHz operation for all Stellaris® devices.

12.2.2.1 Interrupts

The Sample Sequencers dictate the events that cause interrupts, but they don't have control over whether the interrupt is actually sent to the interrupt controller. The ADC module's interrupt signal is controlled by the state of the **MASK** bits in the **ADC Interrupt Mask (ADCIM)** register. Interrupt status can be viewed at two locations: the **ADC Raw Interrupt Status (ADCRIS)** register, which shows the raw status of a Sample Sequencer's interrupt signal, and the **ADC Interrupt Status and Clear (ADCISC)** register, which shows the logical AND of the **ADCRIS** register's **INR** bit and the **ADCIM** register's **MASK** bits. Interrupts are cleared by writing a 1 to the corresponding **IN** bit in **ADCISC**.

12.2.2.2 Prioritization

When sampling events (triggers) happen concurrently, they are prioritized for processing by the values in the **ADC Sample Sequencer Priority (ADCSSPRI)** register. Valid priority values are in the range of 0-3, with 0 being the highest priority and 3 being the lowest. Multiple active Sample Sequencer units with the same priority do not provide consistent results, so software must ensure that all active Sample Sequencer units have a unique priority value.

12.2.2.3 Sampling Events

Sample triggering for each Sample Sequencer is defined in the **ADC Event Multiplexer Select (ADCEMUX)** register. The external peripheral triggering sources vary by Stellaris® family member, but all devices share the "Controller" and "Always" triggers. Software can initiate sampling by setting the **CH** bits in the **ADC Processor Sample Sequence Initiate (ADCPSSI)** register.

When using the "Always" trigger, care must be taken. If a sequence's priority is too high, it is possible to starve other lower priority sequences.

12.2.3 Hardware Sample Averaging Circuit

Higher precision results can be generated using the hardware averaging circuit, however, the improved results are at the cost of throughput. Up to 64 samples can be accumulated and averaged to form a single data entry in the sequencer FIFO. Throughput is decreased proportionally to the number of samples in the averaging calculation. For example, if the averaging circuit is configured to average 16 samples, the throughput is decreased by a factor of 16.

By default the averaging circuit is off and all data from the converter passes through to the sequencer FIFO. The averaging hardware is controlled by the **ADC Sample Averaging Control (ADCSAC)** register (see page 273). There is a single averaging circuit and all input channels receive the same amount of averaging whether they are single-ended or differential.

12.2.4 Analog-to-Digital Converter

The converter itself generates a 10-bit output value for selected analog input. Special analog pads are used to minimize the distortion on the input.

12.2.5 Test Modes

There is a user-available test mode that allows for loopback operation within the digital portion of the ADC module. This can be useful for debugging software without having to provide actual analog stimulus. This mode is available through the **ADC Test Mode Loopback (ADCTMLB)** register (see page 286).

12.3 Initialization and Configuration

In order for the ADC module to be used, the PLL must be enabled and using a supported crystal frequency (see the **RCC** register). Using unsupported frequencies can cause faulty operation in the ADC module.

12.3.1 Module Initialization

Initialization of the ADC module is a simple process with very few steps. The main steps include enabling the clock to the ADC and reconfiguring the Sample Sequencer priorities (if needed).

The initialization sequence for the ADC is as follows:

1. Enable the ADC clock by writing a value of 0x0001.0000 to the **RCGC1** register (see page 96).
2. If required by the application, reconfigure the Sample Sequencer priorities in the **ADCSSPRI** register. The default configuration has Sample Sequencer 0 with the highest priority, and Sample Sequencer 3 as the lowest priority.

12.3.2 Sample Sequencer Configuration

Configuration of the Sample Sequencers is slightly more complex than the module initialization since each sample sequence is completely programmable.

The configuration for each Sample Sequencer should be as follows:

1. Ensure that the Sample Sequencer is disabled by writing a 0 to the corresponding **ASEN** bit in the **ADCACTSS** register. Programming of the Sample Sequencers is allowed without having

them enabled. Disabling the Sequencer during programming prevents erroneous execution if a trigger event were to occur during the configuration process.

2. Configure the trigger event for the Sample Sequencer in the **ADCEMUX** register.
3. For each sample in the sample sequence, configure the corresponding input source in the **ADCSSMUXn** register.
4. For each sample in the sample sequence, configure the sample control bits in the corresponding nibble in the **ADCSSCTLn** register. When programming the last nibble, ensure that the **END** bit is set. Failure to set the **END** bit causes unpredictable behavior.
5. If interrupts are to be used, write a 1 to the corresponding **MASK** bit in the **ADCIM** register.
6. Enable the Sample Sequencer logic by writing a 1 to the corresponding **ASEN** bit in the **ADCACTSS** register.

12.4 Register Map

Table 12-2 on page 260 lists the ADC registers. The offset listed is a hexadecimal increment to the register's address, relative to the ADC base address of 0x4003.8000.

Table 12-2. ADC Register Map

Offset	Name	Type	Reset	Description	See page
0x000	ADCACTSS	R/W	0x0000.0000	ADC Active Sample Sequencer	262
0x004	ADCRIS	RO	0x0000.0000	ADC Raw Interrupt Status	263
0x008	ADCIM	R/W	0x0000.0000	ADC Interrupt Mask	264
0x00C	ADCISC	R/W1C	0x0000.0000	ADC Interrupt Status and Clear	265
0x010	ADCOSTAT	R/W1C	0x0000.0000	ADC Overflow Status	266
0x014	ADCEMUX	R/W	0x0000.0000	ADC Event Multiplexer Select	267
0x018	ADCUSTAT	R/W1C	0x0000.0000	ADC Underflow Status	270
0x020	ADCSSPRI	R/W	0x0000.3210	ADC Sample Sequencer Priority	271
0x028	ADCPSSI	WO	-	ADC Processor Sample Sequence Initiate	272
0x030	ADCSAC	R/W	0x0000.0000	ADC Sample Averaging Control	273
0x040	ADCSSMUX0	R/W	0x0000.0000	ADC Sample Sequence Input Multiplexer Select 0	274
0x044	ADCSSCTL0	R/W	0x0000.0000	ADC Sample Sequence Control 0	276
0x048	ADCSSFIFO0	RO	0x0000.0000	ADC Sample Sequence Result FIFO 0	279
0x04C	ADCSSFSTAT0	RO	0x0000.0100	ADC Sample Sequence FIFO 0 Status	280
0x060	ADCSSMUX1	R/W	0x0000.0000	ADC Sample Sequence Input Multiplexer Select 1	281
0x064	ADCSSCTL1	R/W	0x0000.0000	ADC Sample Sequence Control 1	282
0x068	ADCSSFIFO1	RO	0x0000.0000	ADC Sample Sequence Result FIFO 1	279
0x06C	ADCSSFSTAT1	RO	0x0000.0100	ADC Sample Sequence FIFO 1 Status	280

Offset	Name	Type	Reset	Description	See page
0x080	ADCSSMUX2	R/W	0x0000.0000	ADC Sample Sequence Input Multiplexer Select 2	281
0x084	ADCSSCTL2	R/W	0x0000.0000	ADC Sample Sequence Control 2	282
0x088	ADCSSFIFO2	RO	0x0000.0000	ADC Sample Sequence Result FIFO 2	279
0x08C	ADCSSFSTAT2	RO	0x0000.0100	ADC Sample Sequence FIFO 2 Status	280
0x0A0	ADCSSMUX3	R/W	0x0000.0000	ADC Sample Sequence Input Multiplexer Select 3	284
0x0A4	ADCSSCTL3	R/W	0x0000.0002	ADC Sample Sequence Control 3	285
0x0A8	ADCSSFIFO3	RO	0x0000.0000	ADC Sample Sequence Result FIFO 3	279
0x0AC	ADCSSFSTAT3	RO	0x0000.0100	ADC Sample Sequence FIFO 3 Status	280
0x100	ADCTMLB	R/W	0x0000.0000	ADC Test Mode Loopback	286

12.5 Register Descriptions

The remainder of this section lists and describes the ADC registers, in numerical order by address offset.

Register 1: ADC Active Sample Sequencer (ADCACTSS), offset 0x000

This register controls the activation of the Sample Sequencers. Each Sample Sequencer can be enabled/disabled independently.

ADC Active Sample Sequencer (ADCACTSS)

Base 0x4003.8000
 Offset 0x000
 Type R/W, reset 0x0000.0000

	31	30	29	28	27	26	25	24	23	22	21	20	19	18	17	16
	reserved															
Type	RO	RO	RO	RO	RO	RO	RO	RO	RO	RO	RO	RO	RO	RO	RO	RO
Reset	0	0	0	0	0	0	0	0	0	0	0	0	0	0	0	0
	15	14	13	12	11	10	9	8	7	6	5	4	3	2	1	0
	reserved												ASEN3	ASEN2	ASEN1	ASEN0
Type	RO	RO	RO	RO	RO	RO	RO	RO	RO	RO	RO	RO	R/W	R/W	R/W	R/W
Reset	0	0	0	0	0	0	0	0	0	0	0	0	0	0	0	0

Bit/Field	Name	Type	Reset	Description
31:4	reserved	RO	0x00	Software should not rely on the value of a reserved bit. To provide compatibility with future products, the value of a reserved bit should be preserved across a read-modify-write operation.
3	ASEN3	R/W	0	<p>ADC SS3 Enable</p> <p>Specifies whether Sample Sequencer 3 is enabled. If set, the sample sequence logic for Sequencer 3 is active. Otherwise, the Sequencer is inactive.</p>
2	ASEN2	R/W	0	<p>ADC SS2 Enable</p> <p>Specifies whether Sample Sequencer 2 is enabled. If set, the sample sequence logic for Sequencer 2 is active. Otherwise, the Sequencer is inactive.</p>
1	ASEN1	R/W	0	<p>ADC SS1 Enable</p> <p>Specifies whether Sample Sequencer 1 is enabled. If set, the sample sequence logic for Sequencer 1 is active. Otherwise, the Sequencer is inactive.</p>
0	ASEN0	R/W	0	<p>ADC SS0 Enable</p> <p>Specifies whether Sample Sequencer 0 is enabled. If set, the sample sequence logic for Sequencer 0 is active. Otherwise, the Sequencer is inactive.</p>

Register 2: ADC Raw Interrupt Status (ADCRIS), offset 0x004

This register shows the status of the raw interrupt signal of each Sample Sequencer. These bits may be polled by software to look for interrupt conditions without having to generate controller interrupts.

ADC Raw Interrupt Status (ADCRIS)

Base 0x4003.8000
Offset 0x004
Type RO, reset 0x0000.0000

	31	30	29	28	27	26	25	24	23	22	21	20	19	18	17	16
	reserved															
Type	RO	RO	RO	RO	RO	RO	RO	RO	RO	RO	RO	RO	RO	RO	RO	RO
Reset	0	0	0	0	0	0	0	0	0	0	0	0	0	0	0	0
	15	14	13	12	11	10	9	8	7	6	5	4	3	2	1	0
	reserved												INR3	INR2	INR1	INR0
Type	RO	RO	RO	RO	RO	RO	RO	RO	RO	RO	RO	RO	RO	RO	RO	RO
Reset	0	0	0	0	0	0	0	0	0	0	0	0	0	0	0	0

Bit/Field	Name	Type	Reset	Description
31:4	reserved	RO	0x00	Software should not rely on the value of a reserved bit. To provide compatibility with future products, the value of a reserved bit should be preserved across a read-modify-write operation.
3	INR3	RO	0	SS3 Raw Interrupt Status Set by hardware when a sample with its respective ADCSSCTL3 <small>IE</small> bit has completed conversion. This bit is cleared by writing a 1 to the ADCISC <small>IN3</small> bit.
2	INR2	RO	0	SS2 Raw Interrupt Status Set by hardware when a sample with its respective ADCSSCTL2 <small>IE</small> bit has completed conversion. This bit is cleared by writing a 1 to the ADCISC <small>IN2</small> bit.
1	INR1	RO	0	SS1 Raw Interrupt Status Set by hardware when a sample with its respective ADCSSCTL1 <small>IE</small> bit has completed conversion. This bit is cleared by writing a 1 to the ADCISC <small>IN1</small> bit.
0	INR0	RO	0	SS0 Raw Interrupt Status Set by hardware when a sample with its respective ADCSSCTL0 <small>IE</small> bit has completed conversion. This bit is cleared by writing a 1 to the ADCISC <small>IN0</small> bit.

Register 3: ADC Interrupt Mask (ADCIM), offset 0x008

This register controls whether the Sample Sequencer raw interrupt signals are promoted to controller interrupts. The raw interrupt signal for each Sample Sequencer can be masked independently.

ADC Interrupt Mask (ADCIM)

Base 0x4003.8000
 Offset 0x008
 Type R/W, reset 0x0000.0000

	31	30	29	28	27	26	25	24	23	22	21	20	19	18	17	16
	reserved															
Type	RO	RO	RO	RO	RO	RO	RO	RO	RO	RO	RO	RO	RO	RO	RO	RO
Reset	0	0	0	0	0	0	0	0	0	0	0	0	0	0	0	0
	15	14	13	12	11	10	9	8	7	6	5	4	3	2	1	0
	reserved												MASK3	MASK2	MASK1	MASK0
Type	RO	RO	RO	RO	RO	RO	RO	RO	RO	RO	RO	RO	R/W	R/W	R/W	R/W
Reset	0	0	0	0	0	0	0	0	0	0	0	0	0	0	0	0

Bit/Field	Name	Type	Reset	Description
31:4	reserved	RO	0x00	Software should not rely on the value of a reserved bit. To provide compatibility with future products, the value of a reserved bit should be preserved across a read-modify-write operation.
3	MASK3	R/W	0	SS3 Interrupt Mask Specifies whether the raw interrupt signal from Sample Sequencer 3 (ADCRIS register <i>INR3</i> bit) is promoted to a controller interrupt. If set, the raw interrupt signal is promoted to a controller interrupt. Otherwise, it is not.
2	MASK2	R/W	0	SS2 Interrupt Mask Specifies whether the raw interrupt signal from Sample Sequencer 2 (ADCRIS register <i>INR2</i> bit) is promoted to a controller interrupt. If set, the raw interrupt signal is promoted to a controller interrupt. Otherwise, it is not.
1	MASK1	R/W	0	SS1 Interrupt Mask Specifies whether the raw interrupt signal from Sample Sequencer 1 (ADCRIS register <i>INR1</i> bit) is promoted to a controller interrupt. If set, the raw interrupt signal is promoted to a controller interrupt. Otherwise, it is not.
0	MASK0	R/W	0	SS0 Interrupt Mask Specifies whether the raw interrupt signal from Sample Sequencer 0 (ADCRIS register <i>INR0</i> bit) is promoted to a controller interrupt. If set, the raw interrupt signal is promoted to a controller interrupt. Otherwise, it is not.

Register 4: ADC Interrupt Status and Clear (ADCISC), offset 0x00C

This register provides the mechanism for clearing interrupt conditions, and shows the status of controller interrupts generated by the Sample Sequencers. When read, each bit field is the logical AND of the respective `INR` and `MASK` bits. Interrupts are cleared by writing a 1 to the corresponding bit position. If software is polling the `ADCRIS` instead of generating interrupts, the `INR` bits are still cleared via the `ADCISC` register, even if the `IN` bit is not set.

ADC Interrupt Status and Clear (ADCISC)

Base 0x4003.8000

Offset 0x00C

Type R/W1C, reset 0x0000.0000

	31	30	29	28	27	26	25	24	23	22	21	20	19	18	17	16	
	reserved																
Type	RO	RO	RO	RO	RO	RO	RO	RO	RO	RO	RO	RO	RO	RO	RO	RO	
Reset	0	0	0	0	0	0	0	0	0	0	0	0	0	0	0	0	
	15	14	13	12	11	10	9	8	7	6	5	4	3	2	1	0	
	reserved												IN3	IN2	IN1	IN0	
Type	RO	RO	RO	RO	RO	RO	RO	RO	RO	RO	RO	RO	RO	R/W1C	R/W1C	R/W1C	R/W1C
Reset	0	0	0	0	0	0	0	0	0	0	0	0	0	0	0	0	0

Bit/Field	Name	Type	Reset	Description
31:4	reserved	RO	0x00	Software should not rely on the value of a reserved bit. To provide compatibility with future products, the value of a reserved bit should be preserved across a read-modify-write operation.
3	IN3	R/W1C	0	SS3 Interrupt Status and Clear This bit is set by hardware when the <code>MASK3</code> and <code>INR3</code> bits are both 1, providing a level-based interrupt to the controller. It is cleared by writing a 1, and also clears the <code>INR3</code> bit.
2	IN2	R/W1C	0	SS2 Interrupt Status and Clear This bit is set by hardware when the <code>MASK2</code> and <code>INR2</code> bits are both 1, providing a level based interrupt to the controller. It is cleared by writing a 1, and also clears the <code>INR2</code> bit.
1	IN1	R/W1C	0	SS1 Interrupt Status and Clear This bit is set by hardware when the <code>MASK1</code> and <code>INR1</code> bits are both 1, providing a level based interrupt to the controller. It is cleared by writing a 1, and also clears the <code>INR1</code> bit.
0	IN0	R/W1C	0	SS0 Interrupt Status and Clear This bit is set by hardware when the <code>MASK0</code> and <code>INR0</code> bits are both 1, providing a level based interrupt to the controller. It is cleared by writing a 1, and also clears the <code>INR0</code> bit.

Register 5: ADC Overflow Status (ADCOSTAT), offset 0x010

This register indicates overflow conditions in the Sample Sequencer FIFOs. Once the overflow condition has been handled by software, the condition can be cleared by writing a 1 to the corresponding bit position.

ADC Overflow Status (ADCOSTAT)

Base 0x4003.8000
 Offset 0x010
 Type R/W1C, reset 0x0000.0000

	31	30	29	28	27	26	25	24	23	22	21	20	19	18	17	16
	reserved															
Type	RO	RO	RO	RO	RO	RO	RO	RO	RO	RO	RO	RO	RO	RO	RO	RO
Reset	0	0	0	0	0	0	0	0	0	0	0	0	0	0	0	0
	15	14	13	12	11	10	9	8	7	6	5	4	3	2	1	0
	reserved												OV3	OV2	OV1	OV0
Type	RO	RO	RO	RO	RO	RO	RO	RO	RO	RO	RO	RO	R/W1C	R/W1C	R/W1C	R/W1C
Reset	0	0	0	0	0	0	0	0	0	0	0	0	0	0	0	0

Bit/Field	Name	Type	Reset	Description
31:4	reserved	RO	0x00	Software should not rely on the value of a reserved bit. To provide compatibility with future products, the value of a reserved bit should be preserved across a read-modify-write operation.
3	OV3	R/W1C	0	SS3 FIFO Overflow This bit specifies that the FIFO for Sample Sequencer 3 has hit an overflow condition where the FIFO is full and a write was requested. When an overflow is detected, the most recent write is dropped and this bit is set by hardware to indicate the occurrence of dropped data. This bit is cleared by writing a 1.
2	OV2	R/W1C	0	SS2 FIFO Overflow This bit specifies that the FIFO for Sample Sequencer 2 has hit an overflow condition where the FIFO is full and a write was requested. When an overflow is detected, the most recent write is dropped and this bit is set by hardware to indicate the occurrence of dropped data. This bit is cleared by writing a 1.
1	OV1	R/W1C	0	SS1 FIFO Overflow This bit specifies that the FIFO for Sample Sequencer 1 has hit an overflow condition where the FIFO is full and a write was requested. When an overflow is detected, the most recent write is dropped and this bit is set by hardware to indicate the occurrence of dropped data. This bit is cleared by writing a 1.
0	OV0	R/W1C	0	SS0 FIFO Overflow This bit specifies that the FIFO for Sample Sequencer 0 has hit an overflow condition where the FIFO is full and a write was requested. When an overflow is detected, the most recent write is dropped and this bit is set by hardware to indicate the occurrence of dropped data. This bit is cleared by writing a 1.

Register 6: ADC Event Multiplexer Select (ADCEMUX), offset 0x014

The **ADCEMUX** selects the event (trigger) that initiates sampling for each Sample Sequencer. Each Sample Sequencer can be configured with a unique trigger source.

ADC Event Multiplexer Select (ADCEMUX)

Base 0x4003.8000

Offset 0x014

Type R/W, reset 0x0000.0000

	31	30	29	28	27	26	25	24	23	22	21	20	19	18	17	16
	reserved															
Type	RO	RO	RO	RO	RO	RO	RO	RO	RO	RO	RO	RO	RO	RO	RO	RO
Reset	0	0	0	0	0	0	0	0	0	0	0	0	0	0	0	0
	15	14	13	12	11	10	9	8	7	6	5	4	3	2	1	0
	EM3				EM2				EM1				EM0			
Type	R/W	R/W	R/W	R/W	R/W	R/W	R/W	R/W	R/W	R/W	R/W	R/W	R/W	R/W	R/W	R/W
Reset	0	0	0	0	0	0	0	0	0	0	0	0	0	0	0	0

Bit/Field	Name	Type	Reset	Description																								
31:16	reserved	RO	0x00	Software should not rely on the value of a reserved bit. To provide compatibility with future products, the value of a reserved bit should be preserved across a read-modify-write operation.																								
15:12	EM3	R/W	0x00	SS3 Trigger Select This field selects the trigger source for Sample Sequencer 3. The valid configurations for this field are: <table border="1" style="margin-left: 20px;"> <thead> <tr> <th>Value</th> <th>Event</th> </tr> </thead> <tbody> <tr> <td>0x0</td> <td>Controller (default)</td> </tr> <tr> <td>0x1</td> <td>Reserved</td> </tr> <tr> <td>0x2</td> <td>Reserved</td> </tr> <tr> <td>0x3</td> <td>Reserved</td> </tr> <tr> <td>0x4</td> <td>External (GPIO PB4)</td> </tr> <tr> <td>0x5</td> <td>Timer</td> </tr> <tr> <td>0x6</td> <td>PWM0</td> </tr> <tr> <td>0x7</td> <td>PWM1</td> </tr> <tr> <td>0x8</td> <td>Reserved</td> </tr> <tr> <td>0x9-0xE</td> <td>reserved</td> </tr> <tr> <td>0xF</td> <td>Always (continuously sample)</td> </tr> </tbody> </table>	Value	Event	0x0	Controller (default)	0x1	Reserved	0x2	Reserved	0x3	Reserved	0x4	External (GPIO PB4)	0x5	Timer	0x6	PWM0	0x7	PWM1	0x8	Reserved	0x9-0xE	reserved	0xF	Always (continuously sample)
Value	Event																											
0x0	Controller (default)																											
0x1	Reserved																											
0x2	Reserved																											
0x3	Reserved																											
0x4	External (GPIO PB4)																											
0x5	Timer																											
0x6	PWM0																											
0x7	PWM1																											
0x8	Reserved																											
0x9-0xE	reserved																											
0xF	Always (continuously sample)																											

Bit/Field	Name	Type	Reset	Description																								
11:8	EM2	R/W	0x00	<p>SS2 Trigger Select</p> <p>This field selects the trigger source for Sample Sequencer 2.</p> <p>The valid configurations for this field are:</p> <table border="1"><thead><tr><th>Value</th><th>Event</th></tr></thead><tbody><tr><td>0x0</td><td>Controller (default)</td></tr><tr><td>0x1</td><td>Reserved</td></tr><tr><td>0x2</td><td>Reserved</td></tr><tr><td>0x3</td><td>Reserved</td></tr><tr><td>0x4</td><td>External (GPIO PB4)</td></tr><tr><td>0x5</td><td>Timer</td></tr><tr><td>0x6</td><td>PWM0</td></tr><tr><td>0x7</td><td>PWM1</td></tr><tr><td>0x8</td><td>Reserved</td></tr><tr><td>0x9-0xE</td><td>reserved</td></tr><tr><td>0xF</td><td>Always (continuously sample)</td></tr></tbody></table>	Value	Event	0x0	Controller (default)	0x1	Reserved	0x2	Reserved	0x3	Reserved	0x4	External (GPIO PB4)	0x5	Timer	0x6	PWM0	0x7	PWM1	0x8	Reserved	0x9-0xE	reserved	0xF	Always (continuously sample)
Value	Event																											
0x0	Controller (default)																											
0x1	Reserved																											
0x2	Reserved																											
0x3	Reserved																											
0x4	External (GPIO PB4)																											
0x5	Timer																											
0x6	PWM0																											
0x7	PWM1																											
0x8	Reserved																											
0x9-0xE	reserved																											
0xF	Always (continuously sample)																											
7:4	EM1	R/W	0x00	<p>SS1 Trigger Select</p> <p>This field selects the trigger source for Sample Sequencer 1.</p> <p>The valid configurations for this field are:</p> <table border="1"><thead><tr><th>Value</th><th>Event</th></tr></thead><tbody><tr><td>0x0</td><td>Controller (default)</td></tr><tr><td>0x1</td><td>Reserved</td></tr><tr><td>0x2</td><td>Reserved</td></tr><tr><td>0x3</td><td>Reserved</td></tr><tr><td>0x4</td><td>External (GPIO PB4)</td></tr><tr><td>0x5</td><td>Timer</td></tr><tr><td>0x6</td><td>PWM0</td></tr><tr><td>0x7</td><td>PWM1</td></tr><tr><td>0x8</td><td>Reserved</td></tr><tr><td>0x9-0xE</td><td>reserved</td></tr><tr><td>0xF</td><td>Always (continuously sample)</td></tr></tbody></table>	Value	Event	0x0	Controller (default)	0x1	Reserved	0x2	Reserved	0x3	Reserved	0x4	External (GPIO PB4)	0x5	Timer	0x6	PWM0	0x7	PWM1	0x8	Reserved	0x9-0xE	reserved	0xF	Always (continuously sample)
Value	Event																											
0x0	Controller (default)																											
0x1	Reserved																											
0x2	Reserved																											
0x3	Reserved																											
0x4	External (GPIO PB4)																											
0x5	Timer																											
0x6	PWM0																											
0x7	PWM1																											
0x8	Reserved																											
0x9-0xE	reserved																											
0xF	Always (continuously sample)																											

Bit/Field	Name	Type	Reset	Description																								
3:0	EM0	R/W	0x00	<p>SS0 Trigger Select</p> <p>This field selects the trigger source for Sample Sequencer 0.</p> <p>The valid configurations for this field are:</p> <table><thead><tr><th>Value</th><th>Event</th></tr></thead><tbody><tr><td>0x0</td><td>Controller (default)</td></tr><tr><td>0x1</td><td>Reserved</td></tr><tr><td>0x2</td><td>Reserved</td></tr><tr><td>0x3</td><td>Reserved</td></tr><tr><td>0x4</td><td>External (GPIO PB4)</td></tr><tr><td>0x5</td><td>Timer</td></tr><tr><td>0x6</td><td>PWM0</td></tr><tr><td>0x7</td><td>PWM1</td></tr><tr><td>0x8</td><td>Reserved</td></tr><tr><td>0x9-0xE</td><td>reserved</td></tr><tr><td>0xF</td><td>Always (continuously sample)</td></tr></tbody></table>	Value	Event	0x0	Controller (default)	0x1	Reserved	0x2	Reserved	0x3	Reserved	0x4	External (GPIO PB4)	0x5	Timer	0x6	PWM0	0x7	PWM1	0x8	Reserved	0x9-0xE	reserved	0xF	Always (continuously sample)
Value	Event																											
0x0	Controller (default)																											
0x1	Reserved																											
0x2	Reserved																											
0x3	Reserved																											
0x4	External (GPIO PB4)																											
0x5	Timer																											
0x6	PWM0																											
0x7	PWM1																											
0x8	Reserved																											
0x9-0xE	reserved																											
0xF	Always (continuously sample)																											

Register 7: ADC Underflow Status (ADCUSTAT), offset 0x018

This register indicates underflow conditions in the Sample Sequencer FIFOs. The corresponding underflow condition can be cleared by writing a 1 to the relevant bit position.

ADC Underflow Status (ADCUSTAT)

Base 0x4003.8000
 Offset 0x018
 Type R/W1C, reset 0x0000.0000

	31	30	29	28	27	26	25	24	23	22	21	20	19	18	17	16
	reserved															
Type	RO	RO	RO	RO	RO	RO	RO	RO	RO	RO	RO	RO	RO	RO	RO	RO
Reset	0	0	0	0	0	0	0	0	0	0	0	0	0	0	0	0
	15	14	13	12	11	10	9	8	7	6	5	4	3	2	1	0
	reserved												UV3	UV2	UV1	UV0
Type	RO	RO	RO	RO	RO	RO	RO	RO	RO	RO	RO	RO	R/W1C	R/W1C	R/W1C	R/W1C
Reset	0	0	0	0	0	0	0	0	0	0	0	0	0	0	0	0

Bit/Field	Name	Type	Reset	Description
31:4	reserved	RO	0x00	Software should not rely on the value of a reserved bit. To provide compatibility with future products, the value of a reserved bit should be preserved across a read-modify-write operation.
3	UV3	R/W1C	0	SS3 FIFO Underflow This bit specifies that the FIFO for Sample Sequencer 3 has hit an underflow condition where the FIFO is empty and a read was requested. The problematic read does not move the FIFO pointers, and 0s are returned. This bit is cleared by writing a 1.
2	UV2	R/W1C	0	SS2 FIFO Underflow This bit specifies that the FIFO for Sample Sequencer 2 has hit an underflow condition where the FIFO is empty and a read was requested. The problematic read does not move the FIFO pointers, and 0s are returned. This bit is cleared by writing a 1.
1	UV1	R/W1C	0	SS1 FIFO Underflow This bit specifies that the FIFO for Sample Sequencer 1 has hit an underflow condition where the FIFO is empty and a read was requested. The problematic read does not move the FIFO pointers, and 0s are returned. This bit is cleared by writing a 1.
0	UV0	R/W1C	0	SS0 FIFO Underflow This bit specifies that the FIFO for Sample Sequencer 0 has hit an underflow condition where the FIFO is empty and a read was requested. The problematic read does not move the FIFO pointers, and 0s are returned. This bit is cleared by writing a 1.

Register 8: ADC Sample Sequencer Priority (ADCSSPRI), offset 0x020

This register sets the priority for each of the Sample Sequencers. Out of reset, Sequencer 0 has the highest priority, and sample sequence 3 has the lowest priority. When reconfiguring sequence priorities, each sequence must have a unique priority or the ADC behavior is inconsistent.

ADC Sample Sequencer Priority (ADCSSPRI)

Base 0x4003.8000

Offset 0x020

Type R/W, reset 0x0000.3210

	31	30	29	28	27	26	25	24	23	22	21	20	19	18	17	16
	reserved															
Type	RO	RO	RO	RO	RO	RO	RO	RO	RO	RO	RO	RO	RO	RO	RO	RO
Reset	0	0	0	0	0	0	0	0	0	0	0	0	0	0	0	0
	15	14	13	12	11	10	9	8	7	6	5	4	3	2	1	0
	reserved		SS3		reserved		SS2		reserved		SS1		reserved		SS0	
Type	RO	RO	R/W	R/W	RO	RO	R/W	R/W	RO	RO	R/W	R/W	RO	RO	R/W	R/W
Reset	0	0	1	1	0	0	1	0	0	0	0	1	0	0	0	0

Bit/Field	Name	Type	Reset	Description
31:14	reserved	RO	0x00	Software should not rely on the value of a reserved bit. To provide compatibility with future products, the value of a reserved bit should be preserved across a read-modify-write operation.
13:12	SS3	R/W	0x3	SS3 Priority The SS3 field contains a binary-encoded value that specifies the priority encoding of Sample Sequencer 3. A priority encoding of 0 is highest and 3 is lowest. The priorities assigned to the Sequencers must be uniquely mapped. ADC behavior is not consistent if two or more fields are equal.
11:10	reserved	RO	0x0	Software should not rely on the value of a reserved bit. To provide compatibility with future products, the value of a reserved bit should be preserved across a read-modify-write operation.
9:8	SS2	R/W	0x2	SS2 Priority The SS2 field contains a binary-encoded value that specifies the priority encoding of Sample Sequencer 2.
7:6	reserved	RO	0x0	Software should not rely on the value of a reserved bit. To provide compatibility with future products, the value of a reserved bit should be preserved across a read-modify-write operation.
5:4	SS1	R/W	0x1	SS1 Priority The SS1 field contains a binary-encoded value that specifies the priority encoding of Sample Sequencer 1.
3:2	reserved	RO	0x0	Software should not rely on the value of a reserved bit. To provide compatibility with future products, the value of a reserved bit should be preserved across a read-modify-write operation.
1:0	SS0	R/W	0x0	SS0 Priority The SS0 field contains a binary-encoded value that specifies the priority encoding of Sample Sequencer 0.

Register 9: ADC Processor Sample Sequence Initiate (ADCPSSI), offset 0x028

This register provides a mechanism for application software to initiate sampling in the Sample Sequencers. Sample sequences can be initiated individually or in any combination. When multiple sequences are triggered simultaneously, the priority encodings in **ADCSSPRI** dictate execution order.

ADC Processor Sample Sequence Initiate (ADCPSSI)

Base 0x4003.8000
 Offset 0x028
 Type WO, reset -



Bit/Field	Name	Type	Reset	Description
31:4	reserved	WO	-	Software should not rely on the value of a reserved bit. To provide compatibility with future products, the value of a reserved bit should be preserved across a read-modify-write operation.
3	SS3	WO	-	SS3 Initiate Only a write by software is valid; a read of the register returns no meaningful data. When set by software, sampling is triggered on Sample Sequencer 3, assuming the Sequencer is enabled in the ADCACTSS register.
2	SS2	WO	-	SS2 Initiate Only a write by software is valid; a read of the register returns no meaningful data. When set by software, sampling is triggered on Sample Sequencer 2, assuming the Sequencer is enabled in the ADCACTSS register.
1	SS1	WO	-	SS1 Initiate Only a write by software is valid; a read of the register returns no meaningful data. When set by software, sampling is triggered on Sample Sequencer 1, assuming the Sequencer is enabled in the ADCACTSS register.
0	SS0	WO	-	SS0 Initiate Only a write by software is valid; a read of the register returns no meaningful data. When set by software, sampling is triggered on Sample Sequencer 0, assuming the Sequencer is enabled in the ADCACTSS register.

Register 10: ADC Sample Averaging Control (ADCSAC), offset 0x030

This register controls the amount of hardware averaging applied to conversion results. The final conversion result stored in the FIFO is averaged from 2^{AVG} consecutive ADC samples at the specified ADC speed. If AVG is 0, the sample is passed directly through without any averaging. If AVG=6, then 64 consecutive ADC samples are averaged to generate one result in the sequencer FIFO. An AVG = 7 provides unpredictable results.

ADC Sample Averaging Control (ADCSAC)

Base 0x4003.8000
Offset 0x030
Type R/W, reset 0x0000.0000

	31	30	29	28	27	26	25	24	23	22	21	20	19	18	17	16
	reserved															
Type	RO	RO	RO	RO	RO	RO	RO	RO	RO	RO	RO	RO	RO	RO	RO	RO
Reset	0	0	0	0	0	0	0	0	0	0	0	0	0	0	0	0
	15	14	13	12	11	10	9	8	7	6	5	4	3	2	1	0
	reserved													AVG		
Type	RO	RO	RO	RO	RO	RO	RO	RO	RO	RO	RO	RO	RO	R/W	R/W	R/W
Reset	0	0	0	0	0	0	0	0	0	0	0	0	0	0	0	0

Bit/Field	Name	Type	Reset	Description
31:3	reserved	RO	0x00	Software should not rely on the value of a reserved bit. To provide compatibility with future products, the value of a reserved bit should be preserved across a read-modify-write operation.
2:0	AVG	R/W	0x0	Hardware Averaging Control Specifies the amount of hardware averaging that will be applied to ADC samples. The AVG field can be any value between 0 and 6. Entering a value of 7 creates unpredictable results.
				Value Description
				0x0 No hardware oversampling
				0x1 2x hardware oversampling
				0x2 4x hardware oversampling
				0x3 8x hardware oversampling
				0x4 16x hardware oversampling
				0x5 32x hardware oversampling
				0x6 64x hardware oversampling
				0x7 Reserved

Register 11: ADC Sample Sequence Input Multiplexer Select 0 (ADCSSMUX0), offset 0x040

This register defines the analog input configuration for each sample in a sequence executed with Sample Sequencer 0.

This register is 32-bits wide and contains information for eight possible samples.

ADC Sample Sequence Input Multiplexer Select 0 (ADCSSMUX0)

Base 0x4003.8000
 Offset 0x040
 Type R/W, reset 0x0000.0000

	31	30	29	28	27	26	25	24	23	22	21	20	19	18	17	16
	reserved		MUX7		reserved		MUX6		reserved		MUX5		reserved		MUX4	
Type	RO	RO	R/W	R/W	RO	RO	R/W	R/W	RO	RO	R/W	R/W	RO	RO	R/W	R/W
Reset	0	0	0	0	0	0	0	0	0	0	0	0	0	0	0	0
	15	14	13	12	11	10	9	8	7	6	5	4	3	2	1	0
	reserved		MUX3		reserved		MUX2		reserved		MUX1		reserved		MUX0	
Type	RO	RO	R/W	R/W	RO	RO	R/W	R/W	RO	RO	R/W	R/W	RO	RO	R/W	R/W
Reset	0	0	0	0	0	0	0	0	0	0	0	0	0	0	0	0

Bit/Field	Name	Type	Reset	Description
31:30	reserved	RO	0	Software should not rely on the value of a reserved bit. To provide compatibility with future products, the value of a reserved bit should be preserved across a read-modify-write operation.
29:28	MUX7	R/W	0	8th Sample Input Select The MUX7 field is used during the eighth sample of a sequence executed with the Sample Sequencer. It specifies which of the analog inputs is sampled for the analog-to-digital conversion. The value set here indicates the corresponding pin, for example, a value of 1 indicates the input is ADC1.
27:26	reserved	RO	0	Software should not rely on the value of a reserved bit. To provide compatibility with future products, the value of a reserved bit should be preserved across a read-modify-write operation.
25:24	MUX6	R/W	0	7th Sample Input Select The MUX6 field is used during the seventh sample of a sequence executed with the Sample Sequencer and specifies which of the analog inputs is sampled for the analog-to-digital conversion.
23:22	reserved	RO	0	Software should not rely on the value of a reserved bit. To provide compatibility with future products, the value of a reserved bit should be preserved across a read-modify-write operation.
21:20	MUX5	R/W	0	6th Sample Input Select The MUX5 field is used during the sixth sample of a sequence executed with the Sample Sequencer and specifies which of the analog inputs is sampled for the analog-to-digital conversion.
19:18	reserved	RO	0	Software should not rely on the value of a reserved bit. To provide compatibility with future products, the value of a reserved bit should be preserved across a read-modify-write operation.

Bit/Field	Name	Type	Reset	Description
17:16	MUX4	R/W	0	<p>5th Sample Input Select</p> <p>The MUX4 field is used during the fifth sample of a sequence executed with the Sample Sequencer and specifies which of the analog inputs is sampled for the analog-to-digital conversion.</p>
15:14	reserved	RO	0	Software should not rely on the value of a reserved bit. To provide compatibility with future products, the value of a reserved bit should be preserved across a read-modify-write operation.
13:12	MUX3	R/W	0	<p>4th Sample Input Select</p> <p>The MUX3 field is used during the fourth sample of a sequence executed with the Sample Sequencer and specifies which of the analog inputs is sampled for the analog-to-digital conversion.</p>
11:10	reserved	RO	0	Software should not rely on the value of a reserved bit. To provide compatibility with future products, the value of a reserved bit should be preserved across a read-modify-write operation.
9:8	MUX2	R/W	0	<p>3rd Sample Input Select</p> <p>The MUX2 field is used during the third sample of a sequence executed with the Sample Sequencer and specifies which of the analog inputs is sampled for the analog-to-digital conversion.</p>
7:6	reserved	RO	0	Software should not rely on the value of a reserved bit. To provide compatibility with future products, the value of a reserved bit should be preserved across a read-modify-write operation.
5:4	MUX1	R/W	0	<p>2nd Sample Input Select</p> <p>The MUX1 field is used during the second sample of a sequence executed with the Sample Sequencer and specifies which of the analog inputs is sampled for the analog-to-digital conversion.</p>
3:2	reserved	RO	0	Software should not rely on the value of a reserved bit. To provide compatibility with future products, the value of a reserved bit should be preserved across a read-modify-write operation.
1:0	MUX0	R/W	0	<p>1st Sample Input Select</p> <p>The MUX0 field is used during the first sample of a sequence executed with the Sample Sequencer and specifies which of the analog inputs is sampled for the analog-to-digital conversion.</p>

Register 12: ADC Sample Sequence Control 0 (ADCSCTL0), offset 0x044

This register contains the configuration information for each sample for a sequence executed with Sample Sequencer 0. When configuring a sample sequence, the `END` bit must be set at some point, whether it be after the first sample, last sample, or any sample in between.

This register is 32-bits wide and contains information for eight possible samples.

ADC Sample Sequence Control 0 (ADCSCTL0)

Base 0x4003.8000
 Offset 0x044
 Type R/W, reset 0x0000.0000

	31	30	29	28	27	26	25	24	23	22	21	20	19	18	17	16
	reserved	IE7	END7	D7	reserved	IE6	END6	D6	reserved	IE5	END5	D5	reserved	IE4	END4	D4
Type	RO	R/W	R/W	R/W	RO	R/W	R/W	R/W	RO	R/W	R/W	R/W	RO	R/W	R/W	R/W
Reset	0	0	0	0	0	0	0	0	0	0	0	0	0	0	0	0
	15	14	13	12	11	10	9	8	7	6	5	4	3	2	1	0
	reserved	IE3	END3	D3	reserved	IE2	END2	D2	reserved	IE1	END1	D1	reserved	IE0	END0	D0
Type	RO	R/W	R/W	R/W	RO	R/W	R/W	R/W	RO	R/W	R/W	R/W	RO	R/W	R/W	R/W
Reset	0	0	0	0	0	0	0	0	0	0	0	0	0	0	0	0

Bit/Field	Name	Type	Reset	Description
31	reserved	RO	0	Software should not rely on the value of a reserved bit. To provide compatibility with future products, the value of a reserved bit should be preserved across a read-modify-write operation.
30	IE7	R/W	0	8th Sample Interrupt Enable The <code>IE7</code> bit is used during the eighth sample of the sample sequence and specifies whether the raw interrupt signal (<code>INR0</code> bit) is asserted at the end of the sample's conversion. If the <code>MASK0</code> bit in the <code>ADCIM</code> register is set, the interrupt is promoted to a controller-level interrupt. When this bit is set, the raw interrupt is asserted, otherwise it is not. It is legal to have multiple samples within a sequence generate interrupts.
29	END7	R/W	0	8th Sample is End of Sequence The <code>END7</code> bit indicates that this is the last sample of the sequence. It is possible to end the sequence on any sample position. Samples defined after the sample containing a set <code>END</code> are not requested for conversion even though the fields may be non-zero. It is required that software write the <code>END</code> bit somewhere within the sequence. (Sample Sequencer 3, which only has a single sample in the sequence, is hardwired to have the <code>END0</code> bit set.) Setting this bit indicates that this sample is the last in the sequence.
28	D7	R/W	0	8th Sample Diff Input Select The <code>D7</code> bit indicates that the analog input is to be differentially sampled. The corresponding <code>ADCSSMUXx</code> nibble must be set to the pair number "i", where the paired inputs are "2i and 2i+1". When set, the analog inputs are differentially sampled.
27	reserved	RO	0	Software should not rely on the value of a reserved bit. To provide compatibility with future products, the value of a reserved bit should be preserved across a read-modify-write operation.

Bit/Field	Name	Type	Reset	Description
26	IE6	R/W	0	7th Sample Interrupt Enable Same definition as IE7 but used during the seventh sample.
25	END6	R/W	0	7th Sample is End of Sequence Same definition as END7 but used during the seventh sample.
24	D6	R/W	0	7th Sample Diff Input Select Same definition as D7 but used during the seventh sample.
23	reserved	RO	0	Software should not rely on the value of a reserved bit. To provide compatibility with future products, the value of a reserved bit should be preserved across a read-modify-write operation.
22	IE5	R/W	0	6th Sample Interrupt Enable Same definition as IE7 but used during the sixth sample.
21	END5	R/W	0	6th Sample is End of Sequence Same definition as END7 but used during the sixth sample.
20	D5	R/W	0	6th Sample Diff Input Select Same definition as D7 but used during the sixth sample.
19	reserved	RO	0	Software should not rely on the value of a reserved bit. To provide compatibility with future products, the value of a reserved bit should be preserved across a read-modify-write operation.
18	IE4	R/W	0	5th Sample Interrupt Enable Same definition as IE7 but used during the fifth sample.
17	END4	R/W	0	5th Sample is End of Sequence Same definition as END7 but used during the fifth sample.
16	D4	R/W	0	5th Sample Diff Input Select Same definition as D7 but used during the fifth sample.
15	reserved	RO	0	Software should not rely on the value of a reserved bit. To provide compatibility with future products, the value of a reserved bit should be preserved across a read-modify-write operation.
14	IE3	R/W	0	4th Sample Interrupt Enable Same definition as IE7 but used during the fourth sample.
13	END3	R/W	0	4th Sample is End of Sequence Same definition as END7 but used during the fourth sample.
12	D3	R/W	0	4th Sample Diff Input Select Same definition as D7 but used during the fourth sample.
11	reserved	RO	0	Software should not rely on the value of a reserved bit. To provide compatibility with future products, the value of a reserved bit should be preserved across a read-modify-write operation.

Bit/Field	Name	Type	Reset	Description
10	IE2	R/W	0	3rd Sample Interrupt Enable Same definition as IE7 but used during the third sample.
9	END2	R/W	0	3rd Sample is End of Sequence Same definition as END7 but used during the third sample.
8	D2	R/W	0	3rd Sample Diff Input Select Same definition as D7 but used during the third sample.
7	reserved	RO	0	Software should not rely on the value of a reserved bit. To provide compatibility with future products, the value of a reserved bit should be preserved across a read-modify-write operation.
6	IE1	R/W	0	2nd Sample Interrupt Enable Same definition as IE7 but used during the second sample.
5	END1	R/W	0	2nd Sample is End of Sequence Same definition as END7 but used during the second sample.
4	D1	R/W	0	2nd Sample Diff Input Select Same definition as D7 but used during the second sample.
3	reserved	RO	0	Software should not rely on the value of a reserved bit. To provide compatibility with future products, the value of a reserved bit should be preserved across a read-modify-write operation.
2	IE0	R/W	0	1st Sample Interrupt Enable Same definition as IE7 but used during the first sample.
1	END0	R/W	0	1st Sample is End of Sequence Same definition as END7 but used during the first sample. Since this sequencer has only one entry, this bit must be set.
0	D0	R/W	0	1st Sample Diff Input Select Same definition as D7 but used during the first sample.

Register 13: ADC Sample Sequence Result FIFO 0 (ADCSSFIFO0), offset 0x048

Register 14: ADC Sample Sequence Result FIFO 1 (ADCSSFIFO1), offset 0x068

Register 15: ADC Sample Sequence Result FIFO 2 (ADCSSFIFO2), offset 0x088

Register 16: ADC Sample Sequence Result FIFO 3 (ADCSSFIFO3), offset 0x0A8

This register contains the conversion results for samples collected with the Sample Sequencer (the **ADCSSFIFO0** register is used for Sample Sequencer 0, **ADCSSFIFO1** for Sequencer 1, **ADCSSFIFO2** for Sequencer 2, and **ADCSSFIFO3** for Sequencer 3). Reads of this register return conversion result data in the order sample 0, sample 1, and so on, until the FIFO is empty. If the FIFO is not properly handled by software, overflow and underflow conditions are registered in the **ADCOSTAT** and **ADCUSTAT** registers.

ADC Sample Sequence Result FIFO 0 (ADCSSFIFO0)

Base 0x4003.8000
 Offset 0x048
 Type RO, reset 0x0000.0000

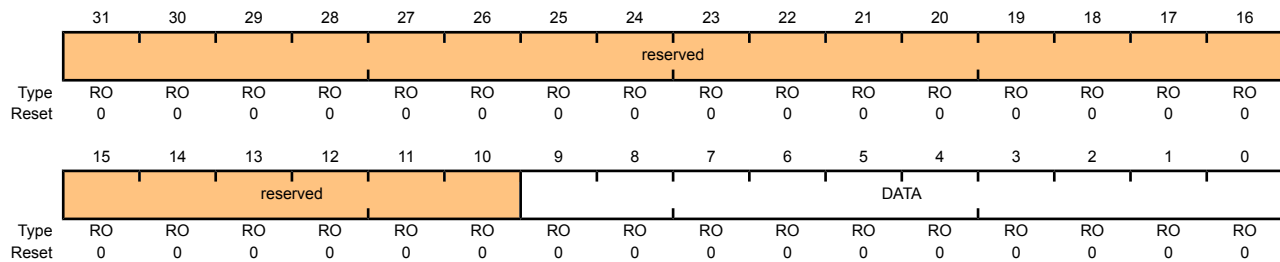

Bit/Field	Name	Type	Reset	Description
31:10	reserved	RO	0x00	Software should not rely on the value of a reserved bit. To provide compatibility with future products, the value of a reserved bit should be preserved across a read-modify-write operation.
9:0	DATA	RO	0x00	Conversion Result Data

Register 17: ADC Sample Sequence FIFO 0 Status (ADCSSFSTAT0), offset 0x04C

Register 18: ADC Sample Sequence FIFO 1 Status (ADCSSFSTAT1), offset 0x06C

Register 19: ADC Sample Sequence FIFO 2 Status (ADCSSFSTAT2), offset 0x08C

Register 20: ADC Sample Sequence FIFO 3 Status (ADCSSFSTAT3), offset 0x0AC

This register provides a window into the Sample Sequencer, providing full/empty status information as well as the positions of the head and tail pointers. The reset value of 0x100 indicates an empty FIFO. The **ADCSSFSTAT0** register provides status on FIFO0, **ADCSSFSTAT1** on FIFO1, **ADCSSFSTAT2** on FIFO2, and **ADCSSFSTAT3** on FIFO3.

ADC Sample Sequence FIFO 0 Status (ADCSSFSTAT0)

Base 0x4003.8000
 Offset 0x04C
 Type RO, reset 0x0000.0100

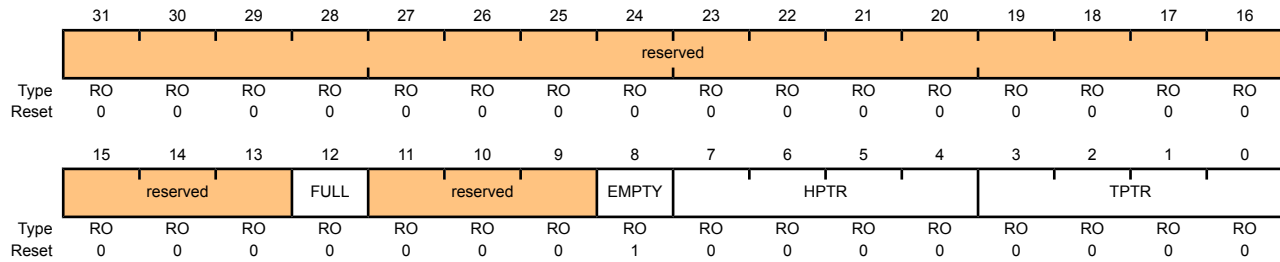

Bit/Field	Name	Type	Reset	Description
31:13	reserved	RO	0x00	Software should not rely on the value of a reserved bit. To provide compatibility with future products, the value of a reserved bit should be preserved across a read-modify-write operation.
12	FULL	RO	0	FIFO Full When set, indicates that the FIFO is currently full.
11:9	reserved	RO	0x00	Software should not rely on the value of a reserved bit. To provide compatibility with future products, the value of a reserved bit should be preserved across a read-modify-write operation.
8	EMPTY	RO	1	FIFO Empty When set, indicates that the FIFO is currently empty.
7:4	HPTR	RO	0x00	FIFO Head Pointer This field contains the current "head" pointer index for the FIFO, that is, the next entry to be written.
3:0	TPTR	RO	0x00	FIFO Tail Pointer This field contains the current "tail" pointer index for the FIFO, that is, the next entry to be read.

Register 21: ADC Sample Sequence Input Multiplexer Select 1 (ADCSSMUX1), offset 0x060

Register 22: ADC Sample Sequence Input Multiplexer Select 2 (ADCSSMUX2), offset 0x080

This register defines the analog input configuration for each sample in a sequence executed with Sample Sequencer 1 or 2. These registers are 16-bits wide and contain information for four possible samples. See the **ADCSSMUX0** register on page 274 for detailed bit descriptions.

ADC Sample Sequence Input Multiplexer Select 1 (ADCSSMUX1)

Base 0x4003.8000

Offset 0x060

Type RO, reset 0x0000.0000

	31	30	29	28	27	26	25	24	23	22	21	20	19	18	17	16
	reserved															
Type	RO	RO	RO	RO	RO	RO	RO	RO	RO	RO	RO	RO	RO	RO	RO	RO
Reset	0	0	0	0	0	0	0	0	0	0	0	0	0	0	0	0
	15	14	13	12	11	10	9	8	7	6	5	4	3	2	1	0
	reserved	MUX3			reserved	MUX2			reserved	MUX1			reserved	MUX0		
Type	RO	R/W	R/W	R/W	RO	R/W	R/W	R/W	RO	R/W	R/W	R/W	RO	R/W	R/W	R/W
Reset	0	0	0	0	0	0	0	0	0	0	0	0	0	0	0	0

Bit/Field	Name	Type	Reset	Description
31:15	reserved	RO	0x00	Software should not rely on the value of a reserved bit. To provide compatibility with future products, the value of a reserved bit should be preserved across a read-modify-write operation.
14:12	MUX3	R/W	0	4th Sample Input Select
11	reserved	RO	0	Software should not rely on the value of a reserved bit. To provide compatibility with future products, the value of a reserved bit should be preserved across a read-modify-write operation.
10:8	MUX2	R/W	0	3rd Sample Input Select
7	reserved	RO	0	Software should not rely on the value of a reserved bit. To provide compatibility with future products, the value of a reserved bit should be preserved across a read-modify-write operation.
6:4	MUX1	R/W	0	2nd Sample Input Select
3	reserved	RO	0	Software should not rely on the value of a reserved bit. To provide compatibility with future products, the value of a reserved bit should be preserved across a read-modify-write operation.
2:0	MUX0	R/W	0	1st Sample Input Select

Register 23: ADC Sample Sequence Control 1 (ADCSSCTL1), offset 0x064

Register 24: ADC Sample Sequence Control 2 (ADCSSCTL2), offset 0x084

These registers contain the configuration information for each sample for a sequence executed with Sample Sequencer 1 or 2. When configuring a sample sequence, the `END` bit must be set at some point, whether it be after the first sample, last sample, or any sample in between. This register is 16-bits wide and contains information for four possible samples. See the `ADCSSCTL0` register on page 276 for detailed bit descriptions.

ADC Sample Sequence Control 1 (ADCSSCTL1)

Base 0x4003.8000
 Offset 0x064
 Type RO, reset 0x0000.0000

	31	30	29	28	27	26	25	24	23	22	21	20	19	18	17	16
	reserved															
Type	RO	RO	RO	RO	RO	RO	RO	RO	RO	RO	RO	RO	RO	RO	RO	RO
Reset	0	0	0	0	0	0	0	0	0	0	0	0	0	0	0	0
	15	14	13	12	11	10	9	8	7	6	5	4	3	2	1	0
	reserved	IE3	END3	D3	reserved	IE2	END2	D2	reserved	IE1	END1	D1	reserved	IE0	END0	D0
Type	RO	R/W	R/W	R/W	RO	R/W	R/W	R/W	RO	R/W	R/W	R/W	RO	R/W	R/W	R/W
Reset	0	0	0	0	0	0	0	0	0	0	0	0	0	0	0	0

Bit/Field	Name	Type	Reset	Description
31:15	reserved	RO	0x00	Software should not rely on the value of a reserved bit. To provide compatibility with future products, the value of a reserved bit should be preserved across a read-modify-write operation.
14	IE3	R/W	0	4th Sample Interrupt Enable Same definition as <code>IE7</code> but used during the fourth sample.
13	END3	R/W	0	4th Sample is End of Sequence Same definition as <code>END7</code> but used during the fourth sample.
12	D3	R/W	0	4th Sample Diff Input Select Same definition as <code>D7</code> but used during the fourth sample.
11	reserved	RO	0	Software should not rely on the value of a reserved bit. To provide compatibility with future products, the value of a reserved bit should be preserved across a read-modify-write operation.
10	IE2	R/W	0	3rd Sample Interrupt Enable Same definition as <code>IE7</code> but used during the third sample.
9	END2	R/W	0	3rd Sample is End of Sequence Same definition as <code>END7</code> but used during the third sample.
8	D2	R/W	0	3rd Sample Diff Input Select Same definition as <code>D7</code> but used during the third sample.
7	reserved	RO	0	Software should not rely on the value of a reserved bit. To provide compatibility with future products, the value of a reserved bit should be preserved across a read-modify-write operation.

Bit/Field	Name	Type	Reset	Description
6	IE1	R/W	0	2nd Sample Interrupt Enable Same definition as IE7 but used during the second sample.
5	END1	R/W	0	2nd Sample is End of Sequence Same definition as END7 but used during the second sample.
4	D1	R/W	0	2nd Sample Diff Input Select Same definition as D7 but used during the second sample.
3	reserved	RO	0	Software should not rely on the value of a reserved bit. To provide compatibility with future products, the value of a reserved bit should be preserved across a read-modify-write operation.
2	IE0	R/W	0	1st Sample Interrupt Enable Same definition as IE7 but used during the first sample.
1	END0	R/W	0	1st Sample is End of Sequence Same definition as END7 but used during the first sample. Since this sequencer has only one entry, this bit must be set.
0	D0	R/W	0	1st Sample Diff Input Select Same definition as D7 but used during the first sample.

Register 25: ADC Sample Sequence Input Multiplexer Select 3 (ADCSSMUX3), offset 0x0A0

This register defines the analog input configuration for each sample in a sequence executed with Sample Sequencer 3. This register is 4-bits wide and contains information for one possible sample. See the **ADCSSMUX0** register on page 274 for detailed bit descriptions.

ADC Sample Sequence Input Multiplexer Select 3 (ADCSSMUX3)

Base 0x4003.8000
 Offset 0x0A0
 Type R/W, reset 0x0000.0000

	31	30	29	28	27	26	25	24	23	22	21	20	19	18	17	16
	reserved															
Type	RO	RO	RO	RO	RO	RO	RO	RO	RO	RO	RO	RO	RO	RO	RO	RO
Reset	0	0	0	0	0	0	0	0	0	0	0	0	0	0	0	0
	15	14	13	12	11	10	9	8	7	6	5	4	3	2	1	0
	reserved													MUX0		
Type	RO	RO	RO	RO	RO	RO	RO	RO	RO	RO	RO	RO	RO	R/W	R/W	R/W
Reset	0	0	0	0	0	0	0	0	0	0	0	0	0	0	0	0

Bit/Field	Name	Type	Reset	Description
31:3	reserved	RO	0x00	Software should not rely on the value of a reserved bit. To provide compatibility with future products, the value of a reserved bit should be preserved across a read-modify-write operation.
2:0	MUX0	R/W	0	1st Sample Input Select

Register 26: ADC Sample Sequence Control 3 (ADCSSCTL3), offset 0x0A4

This register contains the configuration information for each sample for a sequence executed with Sample Sequencer 3. The `END` bit is always set since there is only one sample in this sequencer. This register is 4-bits wide and contains information for one possible sample. See the **ADCSSCTL0** register on page 276 for detailed bit descriptions.

ADC Sample Sequence Control 3 (ADCSSCTL3)

Base 0x4003.8000
Offset 0x0A4
Type R/W, reset 0x0000.0002

	31	30	29	28	27	26	25	24	23	22	21	20	19	18	17	16	
	reserved																
Type	RO	RO	RO	RO	RO	RO	RO	RO	RO	RO	RO	RO	RO	RO	RO	RO	
Reset	0	0	0	0	0	0	0	0	0	0	0	0	0	0	0	0	
	15	14	13	12	11	10	9	8	7	6	5	4	3	2	1	0	
	reserved													IE0	END0	D0	
Type	RO	RO	RO	RO	RO	RO	RO	RO	RO	RO	RO	RO	RO	RO	R/W	R/W	R/W
Reset	0	0	0	0	0	0	0	0	0	0	0	0	0	0	0	1	0

Bit/Field	Name	Type	Reset	Description
31:3	reserved	RO	0x00	Software should not rely on the value of a reserved bit. To provide compatibility with future products, the value of a reserved bit should be preserved across a read-modify-write operation.
2	IE0	R/W	0	1st Sample Interrupt Enable Same definition as <code>IE7</code> but used during the first sample.
1	END0	R/W	1	1st Sample is End of Sequence Same definition as <code>END7</code> but used during the first sample. Since this sequencer has only one entry, this bit must be set.
0	D0	R/W	0	1st Sample Diff Input Select Same definition as <code>D7</code> but used during the first sample.

Register 27: ADC Test Mode Loopback (ADCTMLB), offset 0x100

This register provides loopback operation within the digital logic of the ADC, which can be useful in debugging software without having to provide actual analog stimulus. This test mode is entered by writing a value of 0x0000.0001 to this register. When data is read from the FIFO in loopback mode, the read-only portion of this register is returned.

Read-Only Register

ADC Test Mode Loopback (ADCTMLB)

Base 0x4003.8000
 Offset 0x100
 Type RO, reset 0x0000.0000

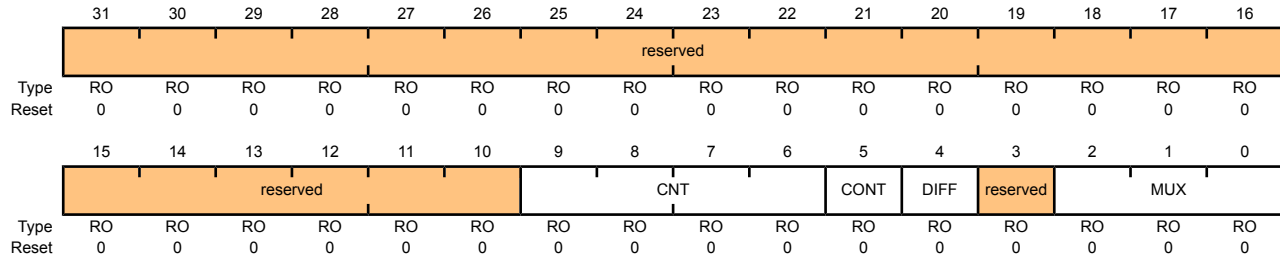

Bit/Field	Name	Type	Reset	Description
31:10	reserved	RO	0x00	Software should not rely on the value of a reserved bit. To provide compatibility with future products, the value of a reserved bit should be preserved across a read-modify-write operation.
9:6	CNT	RO	0x0	Continuous Sample Counter Continuous sample counter that is initialized to 0 and counts each sample as it processed. This helps provide a unique value for the data received.
5	CONT	RO	0	Continuation Sample Indicator When set, indicates that this is a continuation sample. For example, if two sequencers were to run back-to-back, this indicates that the controller kept continuously sampling at full rate.
4	DIFF	RO	0	Differential Sample Indicator When set, indicates that this is a differential sample.
3	reserved	RO	0	Software should not rely on the value of a reserved bit. To provide compatibility with future products, the value of a reserved bit should be preserved across a read-modify-write operation.
2:0	MUX	RO	0x0	Analog Input Indicator Indicates which analog input is to be sampled.

Write-Only Register

ADC Test Mode Loopback (ADCTMLB)

Base 0x4003.8000

Offset 0x100

Type WO, reset 0x0000.0000

	31	30	29	28	27	26	25	24	23	22	21	20	19	18	17	16
	reserved															
Type	RO	RO	RO	RO	RO	RO	RO	RO	RO	RO	RO	RO	RO	RO	RO	RO
Reset	0	0	0	0	0	0	0	0	0	0	0	0	0	0	0	0
	15	14	13	12	11	10	9	8	7	6	5	4	3	2	1	0
	reserved															
Type	RO	RO	RO	RO	RO	RO	RO	RO	RO	RO	RO	RO	RO	RO	RO	WO
Reset	0	0	0	0	0	0	0	0	0	0	0	0	0	0	0	0

Bit/Field	Name	Type	Reset	Description
31:1	reserved	RO	0x00	Software should not rely on the value of a reserved bit. To provide compatibility with future products, the value of a reserved bit should be preserved across a read-modify-write operation.
0	LB	WO	0	<p>Loopback Mode Enable</p> <p>When set, forces a loopback within the digital block to provide information on input and unique numbering.</p> <p>The 10-bit loopback data is defined as shown in the read for bits 9:0 above.</p>

13 Universal Asynchronous Receivers/Transmitters (UARTs)

The Stellaris[®] Universal Asynchronous Receiver/Transmitter (UART) provides fully programmable, 16C550-type serial interface characteristics. The LM3S6916 controller is equipped with three UART modules.

Each UART has the following features:

- Separate transmit and receive FIFOs
- Programmable FIFO length, including 1-byte deep operation providing conventional double-buffered interface
- FIFO trigger levels of 1/8, 1/4, 1/2, 3/4, and 7/8
- Programmable baud-rate generator allowing rates up to 3.125 Mbps
- Standard asynchronous communication bits for start, stop, and parity
- False start bit detection
- Line-break generation and detection
- Fully programmable serial interface characteristics:
 - 5, 6, 7, or 8 data bits
 - Even, odd, stick, or no-parity bit generation/detection
 - 1 or 2 stop bit generation
- IrDA serial-IR (SIR) encoder/decoder providing:
 - Programmable use of IrDA Serial InfraRed (SIR) or UART input/output
 - Support of IrDA SIR encoder/decoder functions for data rates up to 115.2 Kbps half-duplex
 - Support of normal 3/16 and low-power (1.41-2.23 μ s) bit durations
 - Programmable internal clock generator enabling division of reference clock by 1 to 256 for low-power mode bit duration

13.1 Block Diagram

Figure 13-1. UART Module Block Diagram

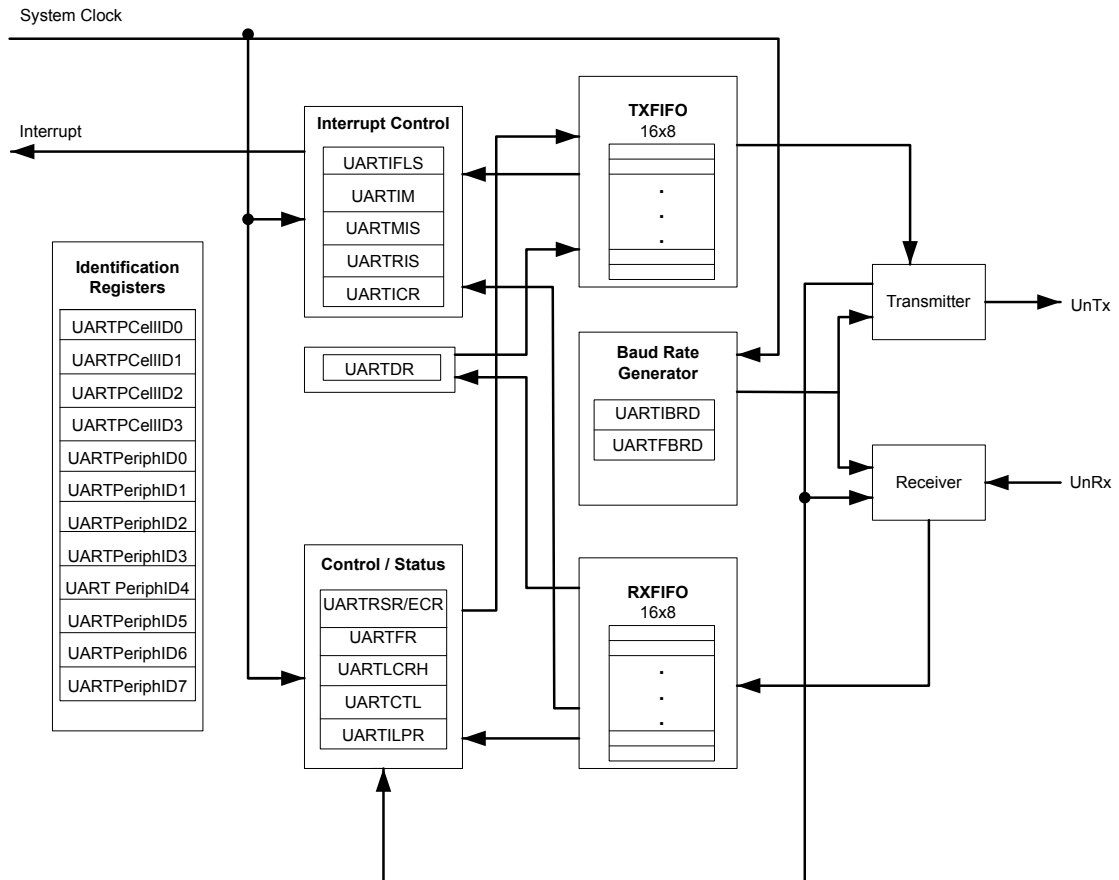

13.2 Functional Description

Each Stellaris[®] UART performs the functions of parallel-to-serial and serial-to-parallel conversions. It is similar in functionality to a 16C550 UART, but is not register compatible.

The UART is configured for transmit and/or receive via the `TXE` and `RXE` bits of the **UART Control (UARTCTL)** register (see page 307). Transmit and receive are both enabled out of reset. Before any control registers are programmed, the UART must be disabled by clearing the `UARTEN` bit in **UARTCTL**. If the UART is disabled during a TX or RX operation, the current transaction is completed prior to the UART stopping.

The UART peripheral also includes a serial IR (SIR) encoder/decoder block that can be connected to an infrared transceiver to implement an IrDA SIR physical layer. The SIR function is programmed using the `UARTCTL` register.

13.2.1 Transmit/Receive Logic

The transmit logic performs parallel-to-serial conversion on the data read from the transmit FIFO. The control logic outputs the serial bit stream beginning with a start bit, and followed by the data

bits (LSB first), parity bit, and the stop bits according to the programmed configuration in the control registers. See Figure 13-2 on page 290 for details.

The receive logic performs serial-to-parallel conversion on the received bit stream after a valid start pulse has been detected. Overrun, parity, frame error checking, and line-break detection are also performed, and their status accompanies the data that is written to the receive FIFO.

Figure 13-2. UART Character Frame

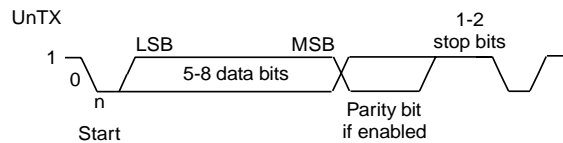

13.2.2 Baud-Rate Generation

The baud-rate divisor is a 22-bit number consisting of a 16-bit integer and a 6-bit fractional part. The number formed by these two values is used by the baud-rate generator to determine the bit period. Having a fractional baud-rate divider allows the UART to generate all the standard baud rates.

The 16-bit integer is loaded through the **UART Integer Baud-Rate Divisor (UARTIBRD)** register (see page 303) and the 6-bit fractional part is loaded with the **UART Fractional Baud-Rate Divisor (UARTFBRD)** register (see page 304). The baud-rate divisor (BRD) has the following relationship to the system clock (where *BRDI* is the integer part of the BRD and *BRDF* is the fractional part, separated by a decimal place.):

$$BRD = BRDI + BRDF = SysClk / (16 * Baud Rate)$$

The 6-bit fractional number (that is to be loaded into the *DIVFRAC* bit field in the **UARTFBRD** register) can be calculated by taking the fractional part of the baud-rate divisor, multiplying it by 64, and adding 0.5 to account for rounding errors:

$$UARTFBRD[DIVFRAC] = integer(BRDF * 64 + 0.5)$$

The UART generates an internal baud-rate reference clock at 16x the baud-rate (referred to as *Baud16*). This reference clock is divided by 16 to generate the transmit clock, and is used for error detection during receive operations.

Along with the **UART Line Control, High Byte (UARTLCRH)** register (see page 305), the **UARTIBRD** and **UARTFBRD** registers form an internal 30-bit register. This internal register is only updated when a write operation to **UARTLCRH** is performed, so any changes to the baud-rate divisor must be followed by a write to the **UARTLCRH** register for the changes to take effect.

To update the baud-rate registers, there are four possible sequences:

- **UARTIBRD** write, **UARTFBRD** write, and **UARTLCRH** write
- **UARTFBRD** write, **UARTIBRD** write, and **UARTLCRH** write
- **UARTIBRD** write and **UARTLCRH** write
- **UARTFBRD** write and **UARTLCRH** write

13.2.3 Data Transmission

Data received or transmitted is stored in two 16-byte FIFOs, though the receive FIFO has an extra four bits per character for status information. For transmission, data is written into the transmit FIFO. If the UART is enabled, it causes a data frame to start transmitting with the parameters indicated in the **UARTLCRH** register. Data continues to be transmitted until there is no data left in the transmit FIFO. The **BUSY** bit in the **UART Flag (UARTFR)** register (see page 300) is asserted as soon as data is written to the transmit FIFO (that is, if the FIFO is non-empty) and remains asserted while data is being transmitted. The **BUSY** bit is negated only when the transmit FIFO is empty, and the last character has been transmitted from the shift register, including the stop bits. The UART can indicate that it is busy even though the UART may no longer be enabled.

When the receiver is idle (the **UnRx** is continuously 1) and the data input goes Low (a start bit has been received), the receive counter begins running and data is sampled on the eighth cycle of **Baud16** (described in “Transmit/Receive Logic” on page 289).

The start bit is valid if **UnRx** is still low on the eighth cycle of **Baud16**, otherwise a false start bit is detected and it is ignored. Start bit errors can be viewed in the **UART Receive Status (UARTSR)** register (see page 298). If the start bit was valid, successive data bits are sampled on every 16th cycle of **Baud16** (that is, one bit period later) according to the programmed length of the data characters. The parity bit is then checked if parity mode was enabled. Data length and parity are defined in the **UARTLCRH** register.

Lastly, a valid stop bit is confirmed if **UnRx** is High, otherwise a framing error has occurred. When a full word is received, the data is stored in the receive FIFO, with any error bits associated with that word.

13.2.4 Serial IR (SIR)

The UART peripheral includes an IrDA serial-IR (SIR) encoder/decoder block. The IrDA SIR block provides functionality that converts between an asynchronous UART data stream, and half-duplex serial SIR interface. No analog processing is performed on-chip. The role of the SIR block is to provide a digital encoded output, and decoded input to the UART. The UART signal pins can be connected to an infrared transceiver to implement an IrDA SIR physical layer link. The SIR block has two modes of operation:

- In normal IrDA mode, a zero logic level is transmitted as high pulse of 3/16th duration of the selected baud rate bit period on the output pin, while logic one levels are transmitted as a static LOW signal. These levels control the driver of an infrared transmitter, sending a pulse of light for each zero. On the reception side, the incoming light pulses energize the photo transistor base of the receiver, pulling its output LOW. This drives the UART input pin LOW.
- In low-power IrDA mode, the width of the transmitted infrared pulse is set to three times the period of the internally generated **IrLPBaud16** signal (1.63 μ s, assuming a nominal 1.8432 MHz frequency) by changing the appropriate bit in the **UARTCR** register.

Figure 13-3 on page 292 shows the UART transmit and receive signals, with and without IrDA modulation.

Figure 13-3. IrDA Data Modulation

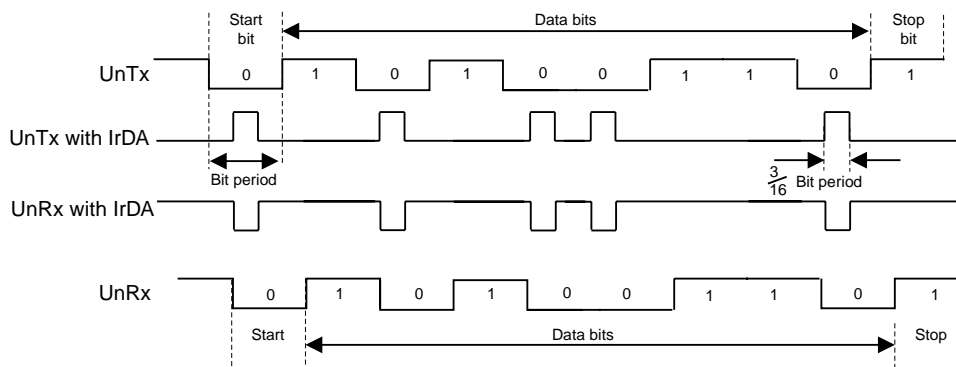

In both normal and low-power IrDA modes:

- During transmission, the UART data bit is used as the base for encoding
- During reception, the decoded bits are transferred to the UART receive logic

The IrDA SIR physical layer specifies a half-duplex communication link, with a minimum 10 ms delay between transmission and reception. This delay must be generated by software because it is not automatically supported by the UART. The delay is required because the infrared receiver electronics might become biased, or even saturated from the optical power coupled from the adjacent transmitter LED. This delay is known as latency, or receiver setup time.

13.2.5 FIFO Operation

The UART has two 16-entry FIFOs; one for transmit and one for receive. Both FIFOs are accessed via the **UART Data (UARTDR)** register (see page 296). Read operations of the **UARTDR** register return a 12-bit value consisting of 8 data bits and 4 error flags while write operations place 8-bit data in the transmit FIFO.

Out of reset, both FIFOs are disabled and act as 1-byte-deep holding registers. The FIFOs are enabled by setting the `FEN` bit in **UARTLCRH** (page 305).

FIFO status can be monitored via the **UART Flag (UARTFR)** register (see page 300) and the **UART Receive Status (UARTRSR)** register. Hardware monitors empty, full and overrun conditions. The **UARTFR** register contains empty and full flags (`TXFE`, `TXFF`, `RXFE`, and `RXFF` bits) and the **UARTRSR** register shows overrun status via the `OE` bit.

The trigger points at which the FIFOs generate interrupts is controlled via the **UART Interrupt FIFO Level Select (UARTIFLS)** register (see page 309). Both FIFOs can be individually configured to trigger interrupts at different levels. Available configurations include $1/8$, $1/4$, $1/2$, $3/4$, and $7/8$. For example, if the $1/4$ option is selected for the receive FIFO, the UART generates a receive interrupt after 4 data bytes are received. Out of reset, both FIFOs are configured to trigger an interrupt at the $1/2$ mark.

13.2.6 Interrupts

The UART can generate interrupts when the following conditions are observed:

- Overrun Error
- Break Error

- Parity Error
- Framing Error
- Receive Timeout
- Transmit (when condition defined in the `TXIFLSEL` bit in the **UARTIFLS** register is met)
- Receive (when condition defined in the `RXIFLSEL` bit in the **UARTIFLS** register is met)

All of the interrupt events are ORed together before being sent to the interrupt controller, so the UART can only generate a single interrupt request to the controller at any given time. Software can service multiple interrupt events in a single interrupt service routine by reading the **UART Masked Interrupt Status (UARTMIS)** register (see page 314).

The interrupt events that can trigger a controller-level interrupt are defined in the **UART Interrupt Mask (UARTIM)** register (see page 311) by setting the corresponding `IM` bit to 1. If interrupts are not used, the raw interrupt status is always visible via the **UART Raw Interrupt Status (UARTRIS)** register (see page 313).

Interrupts are always cleared (for both the **UARTMIS** and **UARTRIS** registers) by setting the corresponding bit in the **UART Interrupt Clear (UARTICR)** register (see page 315).

The receive timeout interrupt is asserted when the receive FIFO is not empty, and no further data is received over a 32-bit period. The receive timeout interrupt is cleared either when the FIFO becomes empty through reading all the data (or by reading the holding register), or when a 1 is written to the corresponding bit in the **UARTICR** register.

13.2.7 Loopback Operation

The UART can be placed into an internal loopback mode for diagnostic or debug work. This is accomplished by setting the `LBE` bit in the **UARTCTL** register (see page 307). In loopback mode, data transmitted on `UnTx` is received on the `UnRx` input.

13.2.8 IrDA SIR block

The IrDA SIR block contains an IrDA serial IR (SIR) protocol encoder/decoder. When enabled, the SIR block uses the `UnTx` and `UnRx` pins for the SIR protocol, which should be connected to an IR transceiver.

The SIR block can receive and transmit, but it is only half-duplex so it cannot do both at the same time. Transmission must be stopped before data can be received. The IrDA SIR physical layer specifies a minimum 10-ms delay between transmission and reception.

13.3 Initialization and Configuration

To use the UARTs, the peripheral clock must be enabled by setting the `UART0`, `UART1`, or `UART2` bits in the **RCGC1** register.

This section discusses the steps that are required for using a UART module. For this example, the system clock is assumed to be 20 MHz and the desired UART configuration is:

- 115200 baud rate
- Data length of 8 bits
- One stop bit

- No parity
- FIFOs disabled
- No interrupts

The first thing to consider when programming the UART is the baud-rate divisor (BRD), since the **UARTIBRD** and **UARTFBRD** registers must be written before the **UARTLCRH** register. Using the equation described in “Baud-Rate Generation” on page 290, the BRD can be calculated:

$$\text{BRD} = 20,000,000 / (16 * 115,200) = 10.8507$$

which means that the `DIVINT` field of the **UARTIBRD** register (see page 303) should be set to 10. The value to be loaded into the **UARTFBRD** register (see page 304) is calculated by the equation:

$$\text{UARTFBRD}[\text{DIVFRAC}] = \text{integer}(0.8507 * 64 + 0.5) = 54$$

With the BRD values in hand, the UART configuration is written to the module in the following order:

1. Disable the UART by clearing the `UARTEN` bit in the **UARTCTL** register.
2. Write the integer portion of the BRD to the **UARTIBRD** register.
3. Write the fractional portion of the BRD to the **UARTFBRD** register.
4. Write the desired serial parameters to the **UARTLCRH** register (in this case, a value of 0x0000.0060).
5. Enable the UART by setting the `UARTEN` bit in the **UARTCTL** register.

13.4 Register Map

Table 13-1 on page 294 lists the UART registers. The offset listed is a hexadecimal increment to the register’s address, relative to that UART’s base address:

- UART0: 0x4000.C000
- UART1: 0x4000.D000
- UART2: 0x4000.E000

Note: The UART must be disabled (see the `UARTEN` bit in the **UARTCTL** register on page 307) before any of the control registers are reprogrammed. When the UART is disabled during a TX or RX operation, the current transaction is completed prior to the UART stopping.

Table 13-1. UART Register Map

Offset	Name	Type	Reset	Description	See page
0x000	UARTDR	R/W	0x0000.0000	UART Data	296
0x004	UARTSR/UARTCR	R/W	0x0000.0000	UART Receive Status/Error Clear	298
0x018	UARTFR	RO	0x0000.0090	UART Flag	300
0x020	UARTILPR	R/W	0x0000.0000	UART IrDA Low-Power Register	302

Offset	Name	Type	Reset	Description	See page
0x024	UARTIBRD	R/W	0x0000.0000	UART Integer Baud-Rate Divisor	303
0x028	UARTFBRD	R/W	0x0000.0000	UART Fractional Baud-Rate Divisor	304
0x02C	UARTLCRH	R/W	0x0000.0000	UART Line Control	305
0x030	UARTCTL	R/W	0x0000.0300	UART Control	307
0x034	UARTIFLS	R/W	0x0000.0012	UART Interrupt FIFO Level Select	309
0x038	UARTIM	R/W	0x0000.0000	UART Interrupt Mask	311
0x03C	UARTRIS	RO	0x0000.000F	UART Raw Interrupt Status	313
0x040	UARTMIS	RO	0x0000.0000	UART Masked Interrupt Status	314
0x044	UARTICR	W1C	0x0000.0000	UART Interrupt Clear	315
0xFD0	UARTPeriphID4	RO	0x0000.0000	UART Peripheral Identification 4	317
0xFD4	UARTPeriphID5	RO	0x0000.0000	UART Peripheral Identification 5	318
0xFD8	UARTPeriphID6	RO	0x0000.0000	UART Peripheral Identification 6	319
0xFDC	UARTPeriphID7	RO	0x0000.0000	UART Peripheral Identification 7	320
0xFE0	UARTPeriphID0	RO	0x0000.0011	UART Peripheral Identification 0	321
0xFE4	UARTPeriphID1	RO	0x0000.0000	UART Peripheral Identification 1	322
0xFE8	UARTPeriphID2	RO	0x0000.0018	UART Peripheral Identification 2	323
0xFEC	UARTPeriphID3	RO	0x0000.0001	UART Peripheral Identification 3	324
0xFF0	UARTPCellID0	RO	0x0000.000D	UART PrimeCell Identification 0	325
0xFF4	UARTPCellID1	RO	0x0000.00F0	UART PrimeCell Identification 1	326
0xFF8	UARTPCellID2	RO	0x0000.0005	UART PrimeCell Identification 2	327
0xFFC	UARTPCellID3	RO	0x0000.00B1	UART PrimeCell Identification 3	328

13.5 Register Descriptions

The remainder of this section lists and describes the UART registers, in numerical order by address offset.

Register 1: UART Data (UARTDR), offset 0x000

This register is the data register (the interface to the FIFOs).

When FIFOs are enabled, data written to this location is pushed onto the transmit FIFO. If FIFOs are disabled, data is stored in the transmitter holding register (the bottom word of the transmit FIFO). A write to this register initiates a transmission from the UART.

For received data, if the FIFO is enabled, the data byte and the 4-bit status (break, frame, parity, and overrun) is pushed onto the 12-bit wide receive FIFO. If FIFOs are disabled, the data byte and status are stored in the receiving holding register (the bottom word of the receive FIFO). The received data can be retrieved by reading this register.

UART Data (UARTDR)

UART0 base: 0x4000.C000
 UART1 base: 0x4000.D000
 UART2 base: 0x4000.E000
 Offset 0x000
 Type R/W, reset 0x0000.0000

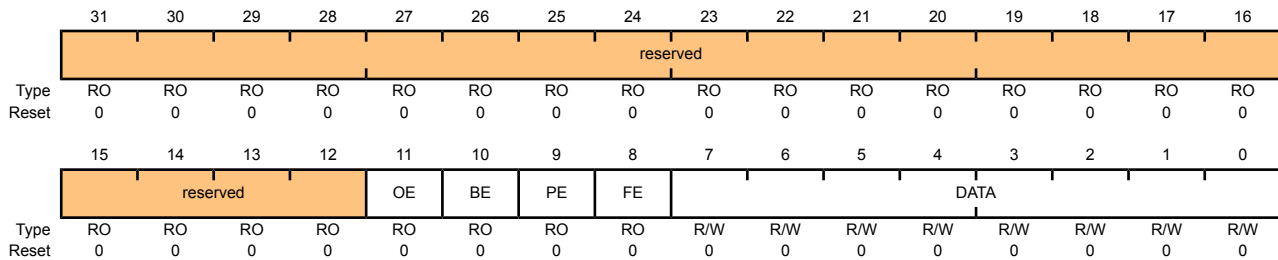

Bit/Field	Name	Type	Reset	Description						
31:12	reserved	RO	0	Software should not rely on the value of a reserved bit. To provide compatibility with future products, the value of a reserved bit should be preserved across a read-modify-write operation.						
11	OE	RO	0	UART Overrun Error The OE values are defined as follows: <table border="1"> <thead> <tr> <th>Value</th> <th>Description</th> </tr> </thead> <tbody> <tr> <td>0</td> <td>There has been no data loss due to a FIFO overrun.</td> </tr> <tr> <td>1</td> <td>New data was received when the FIFO was full, resulting in data loss.</td> </tr> </tbody> </table>	Value	Description	0	There has been no data loss due to a FIFO overrun.	1	New data was received when the FIFO was full, resulting in data loss.
Value	Description									
0	There has been no data loss due to a FIFO overrun.									
1	New data was received when the FIFO was full, resulting in data loss.									
10	BE	RO	0	UART Break Error This bit is set to 1 when a break condition is detected, indicating that the receive data input was held Low for longer than a full-word transmission time (defined as start, data, parity, and stop bits). In FIFO mode, this error is associated with the character at the top of the FIFO. When a break occurs, only one 0 character is loaded into the FIFO. The next character is only enabled after the received data input goes to a 1 (marking state) and the next valid start bit is received.						

Bit/Field	Name	Type	Reset	Description
9	PE	RO	0	UART Parity Error This bit is set to 1 when the parity of the received data character does not match the parity defined by bits 2 and 7 of the UARTLCRH register. In FIFO mode, this error is associated with the character at the top of the FIFO.
8	FE	RO	0	UART Framing Error This bit is set to 1 when the received character does not have a valid stop bit (a valid stop bit is 1).
7:0	DATA	R/W	0	Data Transmitted or Received When written, the data that is to be transmitted via the UART. When read, the data that was received by the UART.

Register 2: UART Receive Status/Error Clear (UARTRSR/UARTECR), offset 0x004

The **UARTRSR/UARTECR** register is the receive status register/error clear register.

In addition to the **UARTDR** register, receive status can also be read from the **UARTRSR** register. If the status is read from this register, then the status information corresponds to the entry read from **UARTDR** prior to reading **UARTRSR**. The status information for overrun is set immediately when an overrun condition occurs.

The **UARTRSR** register cannot be written.

A write of any value to the **UARTECR** register clears the framing, parity, break, and overrun errors. All the bits are cleared to 0 on reset.

Read-Only Receive Status (UARTRSR) Register

UART Receive Status/Error Clear (UARTRSR/UARTECR)

UART0 base: 0x4000.C000

UART1 base: 0x4000.D000

UART2 base: 0x4000.E000

Offset 0x004

Type RO, reset 0x0000.0000

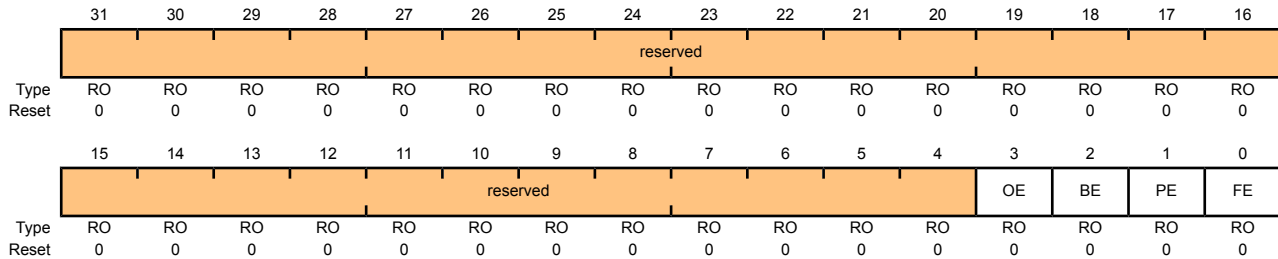

Bit/Field	Name	Type	Reset	Description
31:4	reserved	RO	0	Software should not rely on the value of a reserved bit. To provide compatibility with future products, the value of a reserved bit should be preserved across a read-modify-write operation.
3	OE	RO	0	<p>UART Overrun Error</p> <p>When this bit is set to 1, data is received and the FIFO is already full. This bit is cleared to 0 by a write to UARTECR.</p> <p>The FIFO contents remain valid since no further data is written when the FIFO is full, only the contents of the shift register are overwritten. The CPU must now read the data in order to empty the FIFO.</p>
2	BE	RO	0	<p>UART Break Error</p> <p>This bit is set to 1 when a break condition is detected, indicating that the received data input was held Low for longer than a full-word transmission time (defined as start, data, parity, and stop bits).</p> <p>This bit is cleared to 0 by a write to UARTECR.</p> <p>In FIFO mode, this error is associated with the character at the top of the FIFO. When a break occurs, only one 0 character is loaded into the FIFO. The next character is only enabled after the receive data input goes to a 1 (marking state) and the next valid start bit is received.</p>

Bit/Field	Name	Type	Reset	Description
1	PE	RO	0	<p>UART Parity Error</p> <p>This bit is set to 1 when the parity of the received data character does not match the parity defined by bits 2 and 7 of the UARTLCRH register.</p> <p>This bit is cleared to 0 by a write to UARTECR.</p>
0	FE	RO	0	<p>UART Framing Error</p> <p>This bit is set to 1 when the received character does not have a valid stop bit (a valid stop bit is 1).</p> <p>This bit is cleared to 0 by a write to UARTECR.</p> <p>In FIFO mode, this error is associated with the character at the top of the FIFO.</p>

Write-Only Error Clear (UARTECR) Register

UART Receive Status/Error Clear (UARTRSR/UARTECR)

UART0 base: 0x4000.C000
 UART1 base: 0x4000.D000
 UART2 base: 0x4000.E000
 Offset 0x004
 Type WO, reset 0x0000.0000

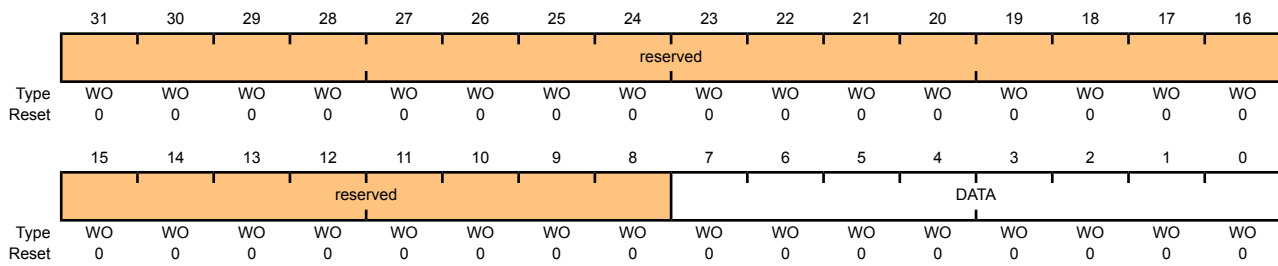

Bit/Field	Name	Type	Reset	Description
31:8	reserved	WO	0	<p>Software should not rely on the value of a reserved bit. To provide compatibility with future products, the value of a reserved bit should be preserved across a read-modify-write operation.</p>
7:0	DATA	WO	0	<p>Error Clear</p> <p>A write to this register of any data clears the framing, parity, break, and overrun flags.</p>

Register 3: UART Flag (UARTFR), offset 0x018

The **UARTFR** register is the flag register. After reset, the **TXFF**, **RXFF**, and **BUSY** bits are 0, and **TXFE** and **RXFE** bits are 1.

UART Flag (UARTFR)

UART0 base: 0x4000.C000
 UART1 base: 0x4000.D000
 UART2 base: 0x4000.E000
 Offset 0x018
 Type RO, reset 0x0000.0090

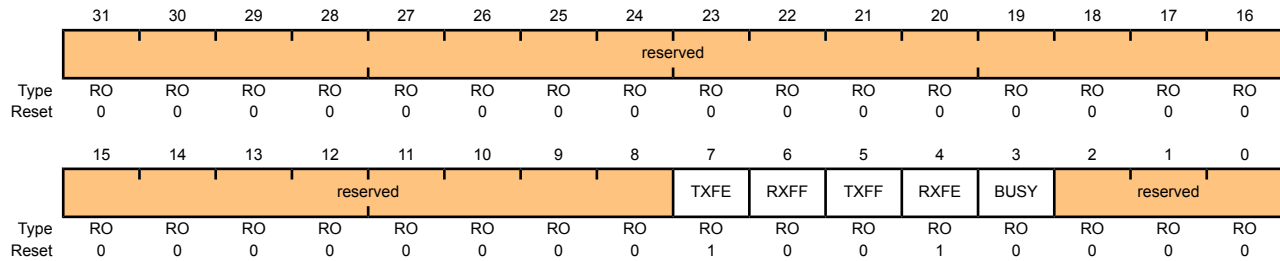

Bit/Field	Name	Type	Reset	Description
31:8	reserved	RO	0	Software should not rely on the value of a reserved bit. To provide compatibility with future products, the value of a reserved bit should be preserved across a read-modify-write operation.
7	TXFE	RO	1	<p>UART Transmit FIFO Empty</p> <p>The meaning of this bit depends on the state of the FEN bit in the UARTLCRH register.</p> <p>If the FIFO is disabled (FEN is 0), this bit is set when the transmit holding register is empty.</p> <p>If the FIFO is enabled (FEN is 1), this bit is set when the transmit FIFO is empty.</p>
6	RXFF	RO	0	<p>UART Receive FIFO Full</p> <p>The meaning of this bit depends on the state of the FEN bit in the UARTLCRH register.</p> <p>If the FIFO is disabled, this bit is set when the receive holding register is full.</p> <p>If the FIFO is enabled, this bit is set when the receive FIFO is full.</p>
5	TXFF	RO	0	<p>UART Transmit FIFO Full</p> <p>The meaning of this bit depends on the state of the FEN bit in the UARTLCRH register.</p> <p>If the FIFO is disabled, this bit is set when the transmit holding register is full.</p> <p>If the FIFO is enabled, this bit is set when the transmit FIFO is full.</p>

Bit/Field	Name	Type	Reset	Description
4	RXFE	RO	1	<p>UART Receive FIFO Empty</p> <p>The meaning of this bit depends on the state of the <code>FEN</code> bit in the UARTLCRH register.</p> <p>If the FIFO is disabled, this bit is set when the receive holding register is empty.</p> <p>If the FIFO is enabled, this bit is set when the receive FIFO is empty.</p>
3	BUSY	RO	0	<p>UART Busy</p> <p>When this bit is 1, the UART is busy transmitting data. This bit remains set until the complete byte, including all stop bits, has been sent from the shift register.</p> <p>This bit is set as soon as the transmit FIFO becomes non-empty (regardless of whether UART is enabled).</p>
2:0	reserved	RO	0	<p>Software should not rely on the value of a reserved bit. To provide compatibility with future products, the value of a reserved bit should be preserved across a read-modify-write operation.</p>

Register 4: UART IrDA Low-Power Register (UARTILPR), offset 0x020

The **UARTILPR** register is an 8-bit read/write register that stores the low-power counter divisor value used to generate the $I_{rLPBaud16}$ signal by dividing down the system clock (SysClk). All the bits are cleared to 0 when reset.

The $I_{rLPBaud16}$ internal signal is generated by dividing down the **UARTCLK** signal according to the low-power divisor value written to **UARTILPR**. The low-power divisor value is calculated as follows:

$$ILPDVSR = \text{SysClk} / F_{I_{rLPBaud16}}$$

where $F_{I_{rLPBaud16}}$ is nominally 1.8432 MHz.

$I_{rLPBaud16}$ is an internal signal used for SIR pulse generation when low-power mode is used. You must choose the divisor so that $1.42 \text{ MHz} < F_{I_{rLPBaud16}} < 2.12 \text{ MHz}$, which results in a low-power pulse duration of 1.41–2.11 μs (three times the period of $I_{rLPBaud16}$). The minimum frequency of $I_{rLPBaud16}$ ensures that pulses less than one period of $I_{rLPBaud16}$ are rejected, but that pulses greater than 1.4 μs are accepted as valid pulses.

Note: Zero is an illegal value. Programming a zero value results in no $I_{rLPBaud16}$ pulses being generated.

UART IrDA Low-Power Register (UARTILPR)

UART0 base: 0x4000.C000
 UART1 base: 0x4000.D000
 UART2 base: 0x4000.E000
 Offset 0x020
 Type R/W, reset 0x0000.0000

	31	30	29	28	27	26	25	24	23	22	21	20	19	18	17	16
	reserved															
Type	RO	RO	RO	RO	RO	RO	RO	RO	RO	RO	RO	RO	RO	RO	RO	RO
Reset	0	0	0	0	0	0	0	0	0	0	0	0	0	0	0	0
	15	14	13	12	11	10	9	8	7	6	5	4	3	2	1	0
	reserved								ILPDVSR							
Type	RO	RO	RO	RO	RO	RO	RO	RO	R/W	R/W	R/W	R/W	R/W	R/W	R/W	R/W
Reset	0	0	0	0	0	0	0	0	0	0	0	0	0	0	0	0

Bit/Field	Name	Type	Reset	Description
31:8	reserved	RO	0	Software should not rely on the value of a reserved bit. To provide compatibility with future products, the value of a reserved bit should be preserved across a read-modify-write operation.
7:0	ILPDVSR	R/W	0x00	IrDA Low-Power Divisor This is an 8-bit low-power divisor value.

Register 5: UART Integer Baud-Rate Divisor (UARTIBRD), offset 0x024

The **UARTIBRD** register is the integer part of the baud-rate divisor value. All the bits are cleared on reset. The minimum possible divide ratio is 1 (when **UARTIBRD**=0), in which case the **UARTFBRD** register is ignored. When changing the **UARTIBRD** register, the new value does not take effect until transmission/reception of the current character is complete. Any changes to the baud-rate divisor must be followed by a write to the **UARTLCRH** register. See “Baud-Rate Generation” on page 290 for configuration details.

UART Integer Baud-Rate Divisor (UARTIBRD)

UART0 base: 0x4000.C000
 UART1 base: 0x4000.D000
 UART2 base: 0x4000.E000
 Offset 0x024
 Type R/W, reset 0x0000.0000

	31	30	29	28	27	26	25	24	23	22	21	20	19	18	17	16
	reserved															
Type	RO	RO	RO	RO	RO	RO	RO	RO	RO	RO	RO	RO	RO	RO	RO	RO
Reset	0	0	0	0	0	0	0	0	0	0	0	0	0	0	0	0
	15	14	13	12	11	10	9	8	7	6	5	4	3	2	1	0
	DIVINT															
Type	R/W	R/W	R/W	R/W	R/W	R/W	R/W	R/W	R/W	R/W	R/W	R/W	R/W	R/W	R/W	R/W
Reset	0	0	0	0	0	0	0	0	0	0	0	0	0	0	0	0

Bit/Field	Name	Type	Reset	Description
31:16	reserved	RO	0	Software should not rely on the value of a reserved bit. To provide compatibility with future products, the value of a reserved bit should be preserved across a read-modify-write operation.
15:0	DIVINT	R/W	0x0000	Integer Baud-Rate Divisor

Register 6: UART Fractional Baud-Rate Divisor (UARTFBRD), offset 0x028

The **UARTFBRD** register is the fractional part of the baud-rate divisor value. All the bits are cleared on reset. When changing the **UARTFBRD** register, the new value does not take effect until transmission/reception of the current character is complete. Any changes to the baud-rate divisor must be followed by a write to the **UARTLCRH** register. See “Baud-Rate Generation” on page 290 for configuration details.

UART Fractional Baud-Rate Divisor (UARTFBRD)

UART0 base: 0x4000.C000
 UART1 base: 0x4000.D000
 UART2 base: 0x4000.E000
 Offset 0x028
 Type R/W, reset 0x0000.0000

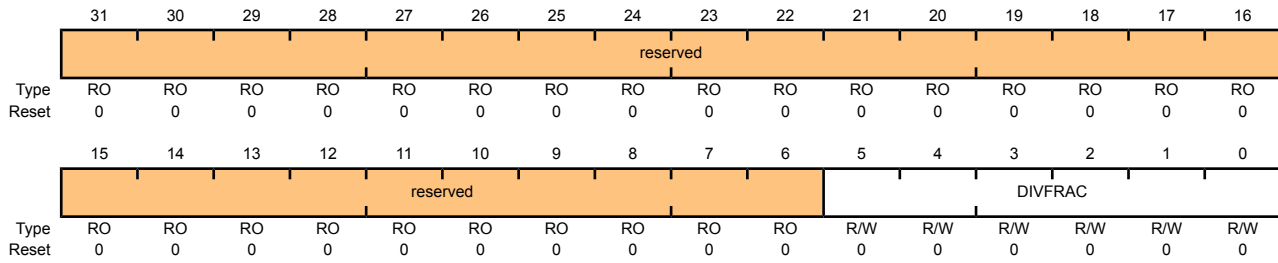

Bit/Field	Name	Type	Reset	Description
31:6	reserved	RO	0x00	Software should not rely on the value of a reserved bit. To provide compatibility with future products, the value of a reserved bit should be preserved across a read-modify-write operation.
5:0	DIVFRAC	R/W	0x000	Fractional Baud-Rate Divisor

Register 7: UART Line Control (UARTLCRH), offset 0x02C

The **UARTLCRH** register is the line control register. Serial parameters such as data length, parity, and stop bit selection are implemented in this register.

When updating the baud-rate divisor (**UARTIBRD** and/or **UARTIFRD**), the **UARTLCRH** register must also be written. The write strobe for the baud-rate divisor registers is tied to the **UARTLCRH** register.

UART Line Control (UARTLCRH)

UART0 base: 0x4000.C000
 UART1 base: 0x4000.D000
 UART2 base: 0x4000.E000
 Offset 0x02C
 Type R/W, reset 0x0000.0000

	31	30	29	28	27	26	25	24	23	22	21	20	19	18	17	16
	reserved															
Type	RO	RO	RO	RO	RO	RO	RO	RO	RO	RO	RO	RO	RO	RO	RO	RO
Reset	0	0	0	0	0	0	0	0	0	0	0	0	0	0	0	0
	15	14	13	12	11	10	9	8	7	6	5	4	3	2	1	0
	reserved								SPS	WLEN		FEN	STP2	EPS	PEN	BRK
Type	RO	RO	RO	RO	RO	RO	RO	RO	R/W	R/W	R/W	R/W	R/W	R/W	R/W	R/W
Reset	0	0	0	0	0	0	0	0	0	0	0	0	0	0	0	0

Bit/Field	Name	Type	Reset	Description										
31:8	reserved	RO	0	Software should not rely on the value of a reserved bit. To provide compatibility with future products, the value of a reserved bit should be preserved across a read-modify-write operation.										
7	SPS	R/W	0	<p>UART Stick Parity Select</p> <p>When bits 1, 2, and 7 of UARTLCRH are set, the parity bit is transmitted and checked as a 0. When bits 1 and 7 are set and 2 is cleared, the parity bit is transmitted and checked as a 1.</p> <p>When this bit is cleared, stick parity is disabled.</p>										
6:5	WLEN	R/W	0	<p>UART Word Length</p> <p>The bits indicate the number of data bits transmitted or received in a frame as follows:</p> <table border="1"> <thead> <tr> <th>Value</th> <th>Description</th> </tr> </thead> <tbody> <tr> <td>0x3</td> <td>8 bits</td> </tr> <tr> <td>0x2</td> <td>7 bits</td> </tr> <tr> <td>0x1</td> <td>6 bits</td> </tr> <tr> <td>0x0</td> <td>5 bits (default)</td> </tr> </tbody> </table>	Value	Description	0x3	8 bits	0x2	7 bits	0x1	6 bits	0x0	5 bits (default)
Value	Description													
0x3	8 bits													
0x2	7 bits													
0x1	6 bits													
0x0	5 bits (default)													
4	FEN	R/W	0	<p>UART Enable FIFOs</p> <p>If this bit is set to 1, transmit and receive FIFO buffers are enabled (FIFO mode).</p> <p>When cleared to 0, FIFOs are disabled (Character mode). The FIFOs become 1-byte-deep holding registers.</p>										

Bit/Field	Name	Type	Reset	Description
3	STP2	R/W	0	<p>UART Two Stop Bits Select</p> <p>If this bit is set to 1, two stop bits are transmitted at the end of a frame. The receive logic does not check for two stop bits being received.</p>
2	EPS	R/W	0	<p>UART Even Parity Select</p> <p>If this bit is set to 1, even parity generation and checking is performed during transmission and reception, which checks for an even number of 1s in data and parity bits.</p> <p>When cleared to 0, then odd parity is performed, which checks for an odd number of 1s.</p> <p>This bit has no effect when parity is disabled by the <code>PEN</code> bit.</p>
1	PEN	R/W	0	<p>UART Parity Enable</p> <p>If this bit is set to 1, parity checking and generation is enabled; otherwise, parity is disabled and no parity bit is added to the data frame.</p>
0	BRK	R/W	0	<p>UART Send Break</p> <p>If this bit is set to 1, a Low level is continually output on the <code>U_nTX</code> output, after completing transmission of the current character. For the proper execution of the break command, the software must set this bit for at least two frames (character periods). For normal use, this bit must be cleared to 0.</p>

Register 8: UART Control (UARTCTL), offset 0x030

The **UARTCTL** register is the control register. All the bits are cleared on reset except for the Transmit Enable (TXE) and Receive Enable (RXE) bits, which are set to 1.

To enable the UART module, the **UARTEN** bit must be set to 1. If software requires a configuration change in the module, the **UARTEN** bit must be cleared before the configuration changes are written. If the UART is disabled during a transmit or receive operation, the current transaction is completed prior to the UART stopping.

UART Control (UARTCTL)

UART0 base: 0x4000.C000
 UART1 base: 0x4000.D000
 UART2 base: 0x4000.E000
 Offset 0x030
 Type R/W, reset 0x0000.0300

	31	30	29	28	27	26	25	24	23	22	21	20	19	18	17	16
	reserved															
Type	RO	RO	RO	RO	RO	RO	RO	RO	RO	RO	RO	RO	RO	RO	RO	RO
Reset	0	0	0	0	0	0	0	0	0	0	0	0	0	0	0	0
	15	14	13	12	11	10	9	8	7	6	5	4	3	2	1	0
	reserved						RXE	TXE	LBE	reserved				SIRLP	SIREN	UARTEN
Type	RO	RO	RO	RO	RO	RO	R/W	R/W	R/W	RO	RO	RO	RO	R/W	R/W	R/W
Reset	0	0	0	0	0	0	1	1	0	0	0	0	0	0	0	0

Bit/Field	Name	Type	Reset	Description
31:10	reserved	RO	0	Software should not rely on the value of a reserved bit. To provide compatibility with future products, the value of a reserved bit should be preserved across a read-modify-write operation.
9	RXE	R/W	1	UART Receive Enable If this bit is set to 1, the receive section of the UART is enabled. When the UART is disabled in the middle of a receive, it completes the current character before stopping. Note: To enable reception, the UARTEN bit must also be set.
8	TXE	R/W	1	UART Transmit Enable If this bit is set to 1, the transmit section of the UART is enabled. When the UART is disabled in the middle of a transmission, it completes the current character before stopping. Note: To enable transmission, the UARTEN bit must also be set.
7	LBE	R/W	0	UART Loop Back Enable If this bit is set to 1, the UnTX path is fed through the UnRX path.
6:3	reserved	RO	0	Software should not rely on the value of a reserved bit. To provide compatibility with future products, the value of a reserved bit should be preserved across a read-modify-write operation.

Bit/Field	Name	Type	Reset	Description
2	SIRLP	R/W	0	UART SIR Low Power Mode This bit selects the IrDA encoding mode. If this bit is cleared to 0, low-level bits are transmitted as an active High pulse with a width of 3/16th of the bit period. If this bit is set to 1, low-level bits are transmitted with a pulse width which is 3 times the period of the $IrLPBaud16$ input signal, regardless of the selected bit rate. Setting this bit uses less power, but might reduce transmission distances. See page 302 for more information.
1	SIREN	R/W	0	UART SIR Enable If this bit is set to 1, the IrDA SIR block is enabled, and the UART will transmit and receive data using SIR protocol.
0	UARTEN	R/W	0	UART Enable If this bit is set to 1, the UART is enabled. When the UART is disabled in the middle of transmission or reception, it completes the current character before stopping.

Register 9: UART Interrupt FIFO Level Select (UARTIFLS), offset 0x034

The **UARTIFLS** register is the interrupt FIFO level select register. You can use this register to define the FIFO level at which the **TXRIS** and **RXRIS** bits in the **UARTRIS** register are triggered.

The interrupts are generated based on a transition through a level rather than being based on the level. That is, the interrupts are generated when the fill level progresses through the trigger level. For example, if the receive trigger level is set to the half-way mark, the interrupt is triggered as the module is receiving the 9th character.

Out of reset, the **TXIFLSEL** and **RXIFLSEL** bits are configured so that the FIFOs trigger an interrupt at the half-way mark.

UART Interrupt FIFO Level Select (UARTIFLS)

UART0 base: 0x4000.C000
 UART1 base: 0x4000.D000
 UART2 base: 0x4000.E000
 Offset 0x034
 Type R/W, reset 0x0000.0012

	31	30	29	28	27	26	25	24	23	22	21	20	19	18	17	16
	reserved															
Type	RO	RO	RO	RO	RO	RO	RO	RO	RO	RO	RO	RO	RO	RO	RO	RO
Reset	0	0	0	0	0	0	0	0	0	0	0	0	0	0	0	0
	15	14	13	12	11	10	9	8	7	6	5	4	3	2	1	0
	reserved										RXIFLSEL			TXIFLSEL		
Type	RO	RO	RO	RO	RO	RO	RO	RO	RO	RO	R/W	R/W	R/W	R/W	R/W	R/W
Reset	0	0	0	0	0	0	0	0	0	0	0	1	0	0	1	0

Bit/Field	Name	Type	Reset	Description
31:6	reserved	RO	0x00	Software should not rely on the value of a reserved bit. To provide compatibility with future products, the value of a reserved bit should be preserved across a read-modify-write operation.
5:3	RXIFLSEL	R/W	0x2	UART Receive Interrupt FIFO Level Select

The trigger points for the receive interrupt are as follows:

Value	Description
0x0	RX FIFO \geq 1/8 full
0x1	RX FIFO \geq 1/4 full
0x2	RX FIFO \geq 1/2 full (default)
0x3	RX FIFO \geq 3/4 full
0x4	RX FIFO \geq 7/8 full
0x5-0x7	Reserved

Bit/Field	Name	Type	Reset	Description
2:0	TXIFLSEL	R/W	0x2	UART Transmit Interrupt FIFO Level Select The trigger points for the transmit interrupt are as follows: Value Description 0x0 TX FIFO \leq 1/8 full 0x1 TX FIFO \leq 1/4 full 0x2 TX FIFO \leq 1/2 full (default) 0x3 TX FIFO \leq 3/4 full 0x4 TX FIFO \leq 7/8 full 0x5-0x7 Reserved

Register 10: UART Interrupt Mask (UARTIM), offset 0x038

The **UARTIM** register is the interrupt mask set/clear register.

On a read, this register gives the current value of the mask on the relevant interrupt. Writing a 1 to a bit allows the corresponding raw interrupt signal to be routed to the interrupt controller. Writing a 0 prevents the raw interrupt signal from being sent to the interrupt controller.

UART Interrupt Mask (UARTIM)

UART0 base: 0x4000.C000
 UART1 base: 0x4000.D000
 UART2 base: 0x4000.E000
 Offset 0x038
 Type R/W, reset 0x0000.0000

	31	30	29	28	27	26	25	24	23	22	21	20	19	18	17	16
	reserved															
Type	RO	RO	RO	RO	RO	RO	RO	RO	RO	RO	RO	RO	RO	RO	RO	RO
Reset	0	0	0	0	0	0	0	0	0	0	0	0	0	0	0	0
	15	14	13	12	11	10	9	8	7	6	5	4	3	2	1	0
	reserved				OEIM	BEIM	PEIM	FEIM	RTIM	TXIM	RXIM	reserved				
Type	RO	RO	RO	RO	RO	R/W	R/W	R/W	R/W	R/W	R/W	R/W	RO	RO	RO	RO
Reset	0	0	0	0	0	0	0	0	0	0	0	0	0	0	0	0

Bit/Field	Name	Type	Reset	Description
31:11	reserved	RO	0x00	Software should not rely on the value of a reserved bit. To provide compatibility with future products, the value of a reserved bit should be preserved across a read-modify-write operation.
10	OEIM	R/W	0	UART Overrun Error Interrupt Mask On a read, the current mask for the OEIM interrupt is returned. Setting this bit to 1 promotes the OEIM interrupt to the interrupt controller.
9	BEIM	R/W	0	UART Break Error Interrupt Mask On a read, the current mask for the BEIM interrupt is returned. Setting this bit to 1 promotes the BEIM interrupt to the interrupt controller.
8	PEIM	R/W	0	UART Parity Error Interrupt Mask On a read, the current mask for the PEIM interrupt is returned. Setting this bit to 1 promotes the PEIM interrupt to the interrupt controller.
7	FEIM	R/W	0	UART Framing Error Interrupt Mask On a read, the current mask for the FEIM interrupt is returned. Setting this bit to 1 promotes the FEIM interrupt to the interrupt controller.
6	RTIM	R/W	0	UART Receive Time-Out Interrupt Mask On a read, the current mask for the RTIM interrupt is returned. Setting this bit to 1 promotes the RTIM interrupt to the interrupt controller.
5	TXIM	R/W	0	UART Transmit Interrupt Mask On a read, the current mask for the TXIM interrupt is returned. Setting this bit to 1 promotes the TXIM interrupt to the interrupt controller.

Bit/Field	Name	Type	Reset	Description
4	RXIM	R/W	0	UART Receive Interrupt Mask On a read, the current mask for the <code>RXIM</code> interrupt is returned. Setting this bit to 1 promotes the <code>RXIM</code> interrupt to the interrupt controller.
3:0	reserved	RO	0x00	Software should not rely on the value of a reserved bit. To provide compatibility with future products, the value of a reserved bit should be preserved across a read-modify-write operation.

Register 11: UART Raw Interrupt Status (UARTRIS), offset 0x03C

The **UARTRIS** register is the raw interrupt status register. On a read, this register gives the current raw status value of the corresponding interrupt. A write has no effect.

UART Raw Interrupt Status (UARTRIS)

UART0 base: 0x4000.C000
 UART1 base: 0x4000.D000
 UART2 base: 0x4000.E000
 Offset 0x03C
 Type RO, reset 0x0000.000F

	31	30	29	28	27	26	25	24	23	22	21	20	19	18	17	16
	reserved															
Type	RO	RO	RO	RO	RO	RO	RO	RO	RO	RO	RO	RO	RO	RO	RO	RO
Reset	0	0	0	0	0	0	0	0	0	0	0	0	0	0	0	0
	15	14	13	12	11	10	9	8	7	6	5	4	3	2	1	0
	reserved						OERIS	BERIS	PERIS	FERIS	RTRIS	TXRIS	RXRIS	reserved		
Type	RO	RO	RO	RO	RO	RO	RO	RO	RO	RO	RO	RO	RO	RO	RO	RO
Reset	0	0	0	0	0	0	0	0	0	0	0	0	0	1	1	1

Bit/Field	Name	Type	Reset	Description
31:11	reserved	RO	0x00	Software should not rely on the value of a reserved bit. To provide compatibility with future products, the value of a reserved bit should be preserved across a read-modify-write operation.
10	OERIS	RO	0	UART Overrun Error Raw Interrupt Status Gives the raw interrupt state (prior to masking) of this interrupt.
9	BERIS	RO	0	UART Break Error Raw Interrupt Status Gives the raw interrupt state (prior to masking) of this interrupt.
8	PERIS	RO	0	UART Parity Error Raw Interrupt Status Gives the raw interrupt state (prior to masking) of this interrupt.
7	FERIS	RO	0	UART Framing Error Raw Interrupt Status Gives the raw interrupt state (prior to masking) of this interrupt.
6	RTRIS	RO	0	UART Receive Time-Out Raw Interrupt Status Gives the raw interrupt state (prior to masking) of this interrupt.
5	TXRIS	RO	0	UART Transmit Raw Interrupt Status Gives the raw interrupt state (prior to masking) of this interrupt.
4	RXRIS	RO	0	UART Receive Raw Interrupt Status Gives the raw interrupt state (prior to masking) of this interrupt.
3:0	reserved	RO	0xF	Software should not rely on the value of a reserved bit. To provide compatibility with future products, the value of a reserved bit should be preserved across a read-modify-write operation.

Register 12: UART Masked Interrupt Status (UARTMIS), offset 0x040

The **UARTMIS** register is the masked interrupt status register. On a read, this register gives the current masked status value of the corresponding interrupt. A write has no effect.

UART Masked Interrupt Status (UARTMIS)

UART0 base: 0x4000.C000
 UART1 base: 0x4000.D000
 UART2 base: 0x4000.E000
 Offset 0x040
 Type RO, reset 0x0000.0000

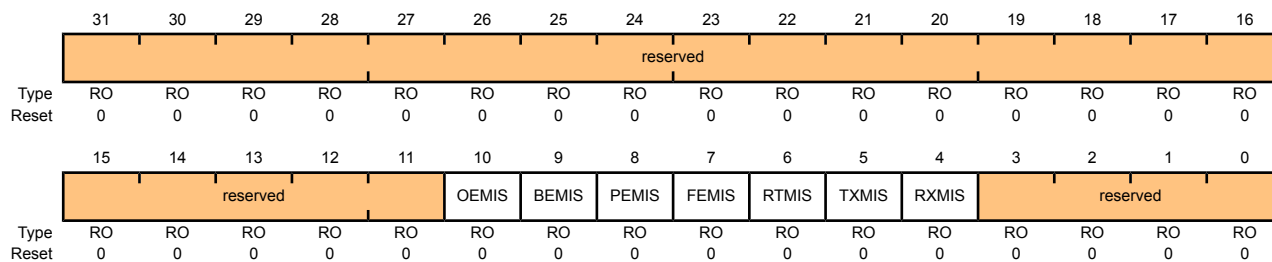

Bit/Field	Name	Type	Reset	Description
31:11	reserved	RO	0x00	Software should not rely on the value of a reserved bit. To provide compatibility with future products, the value of a reserved bit should be preserved across a read-modify-write operation.
10	OEMIS	RO	0	UART Overrun Error Masked Interrupt Status Gives the masked interrupt state of this interrupt.
9	BEMIS	RO	0	UART Break Error Masked Interrupt Status Gives the masked interrupt state of this interrupt.
8	PEMIS	RO	0	UART Parity Error Masked Interrupt Status Gives the masked interrupt state of this interrupt.
7	FEMIS	RO	0	UART Framing Error Masked Interrupt Status Gives the masked interrupt state of this interrupt.
6	RTMIS	RO	0	UART Receive Time-Out Masked Interrupt Status Gives the masked interrupt state of this interrupt.
5	TXMIS	RO	0	UART Transmit Masked Interrupt Status Gives the masked interrupt state of this interrupt.
4	RXMIS	RO	0	UART Receive Masked Interrupt Status Gives the masked interrupt state of this interrupt.
3:0	reserved	RO	0	Software should not rely on the value of a reserved bit. To provide compatibility with future products, the value of a reserved bit should be preserved across a read-modify-write operation.

Register 13: UART Interrupt Clear (UARTICR), offset 0x044

The **UARTICR** register is the interrupt clear register. On a write of 1, the corresponding interrupt (both raw interrupt and masked interrupt, if enabled) is cleared. A write of 0 has no effect.

UART Interrupt Clear (UARTICR)

UART0 base: 0x4000.C000
 UART1 base: 0x4000.D000
 UART2 base: 0x4000.E000
 Offset 0x044
 Type W1C, reset 0x0000.0000

	31	30	29	28	27	26	25	24	23	22	21	20	19	18	17	16
	reserved															
Type	RO	RO	RO	RO	RO	RO	RO	RO	RO	RO	RO	RO	RO	RO	RO	RO
Reset	0	0	0	0	0	0	0	0	0	0	0	0	0	0	0	0
	15	14	13	12	11	10	9	8	7	6	5	4	3	2	1	0
	reserved					OEIC	BEIC	PEIC	FEIC	RTIC	TXIC	RXIC	reserved			
Type	RO	RO	RO	RO	RO	W1C	W1C	W1C	W1C	W1C	W1C	W1C	RO	RO	RO	RO
Reset	0	0	0	0	0	0	0	0	0	0	0	0	0	0	0	0

Bit/Field	Name	Type	Reset	Description						
31:11	reserved	RO	0x00	Software should not rely on the value of a reserved bit. To provide compatibility with future products, the value of a reserved bit should be preserved across a read-modify-write operation.						
10	OEIC	W1C	0	Overrun Error Interrupt Clear The OEIC values are defined as follows: <table border="0"> <tr> <td>Value</td> <td>Description</td> </tr> <tr> <td>0</td> <td>No effect on the interrupt.</td> </tr> <tr> <td>1</td> <td>Clears interrupt.</td> </tr> </table>	Value	Description	0	No effect on the interrupt.	1	Clears interrupt.
Value	Description									
0	No effect on the interrupt.									
1	Clears interrupt.									
9	BEIC	W1C	0	Break Error Interrupt Clear The BEIC values are defined as follows: <table border="0"> <tr> <td>Value</td> <td>Description</td> </tr> <tr> <td>0</td> <td>No effect on the interrupt.</td> </tr> <tr> <td>1</td> <td>Clears interrupt.</td> </tr> </table>	Value	Description	0	No effect on the interrupt.	1	Clears interrupt.
Value	Description									
0	No effect on the interrupt.									
1	Clears interrupt.									
8	PEIC	W1C	0	Parity Error Interrupt Clear The PEIC values are defined as follows: <table border="0"> <tr> <td>Value</td> <td>Description</td> </tr> <tr> <td>0</td> <td>No effect on the interrupt.</td> </tr> <tr> <td>1</td> <td>Clears interrupt.</td> </tr> </table>	Value	Description	0	No effect on the interrupt.	1	Clears interrupt.
Value	Description									
0	No effect on the interrupt.									
1	Clears interrupt.									

Bit/Field	Name	Type	Reset	Description
7	FEIC	W1C	0	Framing Error Interrupt Clear The FEIC values are defined as follows: Value Description 0 No effect on the interrupt. 1 Clears interrupt.
6	RTIC	W1C	0	Receive Time-Out Interrupt Clear The RTIC values are defined as follows: Value Description 0 No effect on the interrupt. 1 Clears interrupt.
5	TXIC	W1C	0	Transmit Interrupt Clear The TXIC values are defined as follows: Value Description 0 No effect on the interrupt. 1 Clears interrupt.
4	RXIC	W1C	0	Receive Interrupt Clear The RXIC values are defined as follows: Value Description 0 No effect on the interrupt. 1 Clears interrupt.
3:0	reserved	RO	0x00	Software should not rely on the value of a reserved bit. To provide compatibility with future products, the value of a reserved bit should be preserved across a read-modify-write operation.

Register 14: UART Peripheral Identification 4 (UARTPeriphID4), offset 0xFD0

The **UARTPeriphIDn** registers are hard-coded and the fields within the registers determine the reset values.

UART Peripheral Identification 4 (UARTPeriphID4)

UART0 base: 0x4000.C000
 UART1 base: 0x4000.D000
 UART2 base: 0x4000.E000
 Offset 0xFD0
 Type RO, reset 0x0000.0000

	31	30	29	28	27	26	25	24	23	22	21	20	19	18	17	16
	reserved															
Type	RO	RO	RO	RO	RO	RO	RO	RO	RO	RO	RO	RO	RO	RO	RO	RO
Reset	0	0	0	0	0	0	0	0	0	0	0	0	0	0	0	0
	15	14	13	12	11	10	9	8	7	6	5	4	3	2	1	0
	reserved								PID4							
Type	RO	RO	RO	RO	RO	RO	RO	RO	RO	RO	RO	RO	RO	RO	RO	RO
Reset	0	0	0	0	0	0	0	0	0	0	0	0	0	0	0	0

Bit/Field	Name	Type	Reset	Description
31:8	reserved	RO	0x00	Software should not rely on the value of a reserved bit. To provide compatibility with future products, the value of a reserved bit should be preserved across a read-modify-write operation.
7:0	PID4	RO	0x0000	UART Peripheral ID Register[7:0] Can be used by software to identify the presence of this peripheral.

Register 15: UART Peripheral Identification 5 (UARTPeriphID5), offset 0xFD4

The **UARTPeriphIDn** registers are hard-coded and the fields within the registers determine the reset values.

UART Peripheral Identification 5 (UARTPeriphID5)

UART0 base: 0x4000.C000
 UART1 base: 0x4000.D000
 UART2 base: 0x4000.E000
 Offset 0xFD4
 Type RO, reset 0x0000.0000

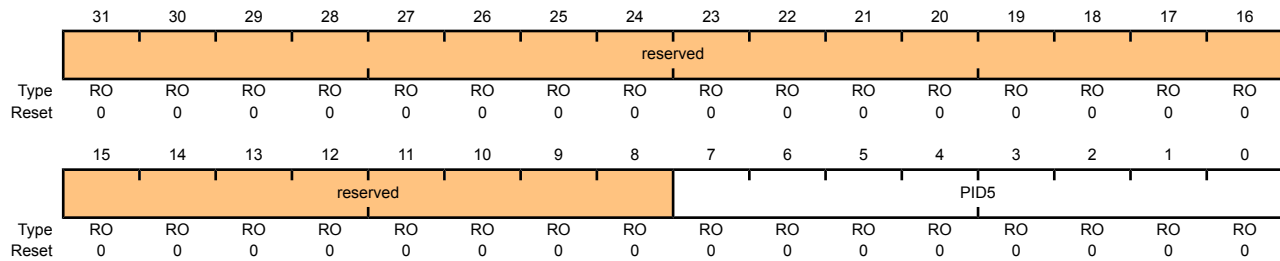

Bit/Field	Name	Type	Reset	Description
31:8	reserved	RO	0x00	Software should not rely on the value of a reserved bit. To provide compatibility with future products, the value of a reserved bit should be preserved across a read-modify-write operation.
7:0	PID5	RO	0x0000	UART Peripheral ID Register[15:8] Can be used by software to identify the presence of this peripheral.

Register 16: UART Peripheral Identification 6 (UARTPeriphID6), offset 0xFD8

The **UARTPeriphIDn** registers are hard-coded and the fields within the registers determine the reset values.

UART Peripheral Identification 6 (UARTPeriphID6)

UART0 base: 0x4000.C000
 UART1 base: 0x4000.D000
 UART2 base: 0x4000.E000
 Offset 0xFD8
 Type RO, reset 0x0000.0000

	31	30	29	28	27	26	25	24	23	22	21	20	19	18	17	16
	reserved															
Type	RO	RO	RO	RO	RO	RO	RO	RO	RO	RO	RO	RO	RO	RO	RO	RO
Reset	0	0	0	0	0	0	0	0	0	0	0	0	0	0	0	0
	15	14	13	12	11	10	9	8	7	6	5	4	3	2	1	0
	reserved								PID6							
Type	RO	RO	RO	RO	RO	RO	RO	RO	RO	RO	RO	RO	RO	RO	RO	RO
Reset	0	0	0	0	0	0	0	0	0	0	0	0	0	0	0	0

Bit/Field	Name	Type	Reset	Description
31:8	reserved	RO	0x00	Software should not rely on the value of a reserved bit. To provide compatibility with future products, the value of a reserved bit should be preserved across a read-modify-write operation.
7:0	PID6	RO	0x0000	UART Peripheral ID Register[23:16] Can be used by software to identify the presence of this peripheral.

Register 17: UART Peripheral Identification 7 (UARTPeriphID7), offset 0xFDC

The **UARTPeriphIDn** registers are hard-coded and the fields within the registers determine the reset values.

UART Peripheral Identification 7 (UARTPeriphID7)

UART0 base: 0x4000.C000
 UART1 base: 0x4000.D000
 UART2 base: 0x4000.E000
 Offset 0xFDC
 Type RO, reset 0x0000.0000



Bit/Field	Name	Type	Reset	Description
31:8	reserved	RO	0	Software should not rely on the value of a reserved bit. To provide compatibility with future products, the value of a reserved bit should be preserved across a read-modify-write operation.
7:0	PID7	RO	0x0000	UART Peripheral ID Register[31:24] Can be used by software to identify the presence of this peripheral.

Register 18: UART Peripheral Identification 0 (UARTPeriphID0), offset 0xFE0

The **UARTPeriphIDn** registers are hard-coded and the fields within the registers determine the reset values.

UART Peripheral Identification 0 (UARTPeriphID0)

UART0 base: 0x4000.C000
 UART1 base: 0x4000.D000
 UART2 base: 0x4000.E000
 Offset 0xFE0
 Type RO, reset 0x0000.0011

	31	30	29	28	27	26	25	24	23	22	21	20	19	18	17	16
	reserved															
Type	RO	RO	RO	RO	RO	RO	RO	RO	RO	RO	RO	RO	RO	RO	RO	RO
Reset	0	0	0	0	0	0	0	0	0	0	0	0	0	0	0	0
	15	14	13	12	11	10	9	8	7	6	5	4	3	2	1	0
	reserved								PID0							
Type	RO	RO	RO	RO	RO	RO	RO	RO	RO	RO	RO	RO	RO	RO	RO	RO
Reset	0	0	0	0	0	0	0	0	0	0	0	1	0	0	0	1

Bit/Field	Name	Type	Reset	Description
31:8	reserved	RO	0x00	Software should not rely on the value of a reserved bit. To provide compatibility with future products, the value of a reserved bit should be preserved across a read-modify-write operation.
7:0	PID0	RO	0x11	UART Peripheral ID Register[7:0] Can be used by software to identify the presence of this peripheral.

Register 19: UART Peripheral Identification 1 (UARTPeriphID1), offset 0xFE4

The **UARTPeriphIDn** registers are hard-coded and the fields within the registers determine the reset values.

UART Peripheral Identification 1 (UARTPeriphID1)

UART0 base: 0x4000.C000
 UART1 base: 0x4000.D000
 UART2 base: 0x4000.E000
 Offset 0xFE4
 Type RO, reset 0x0000.0000

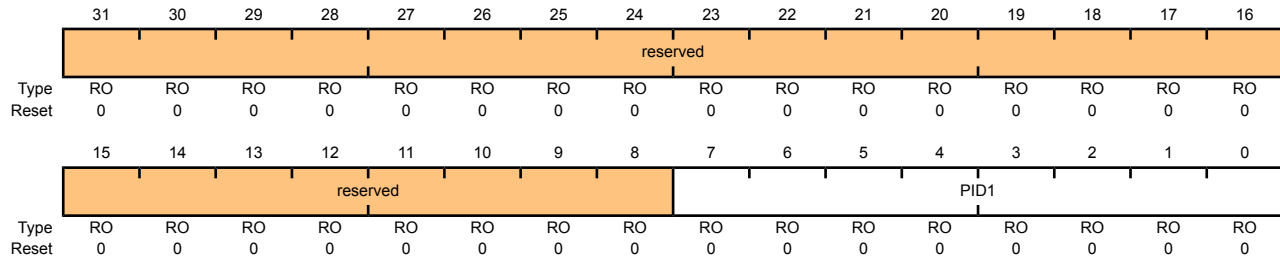

Bit/Field	Name	Type	Reset	Description
31:8	reserved	RO	0x00	Software should not rely on the value of a reserved bit. To provide compatibility with future products, the value of a reserved bit should be preserved across a read-modify-write operation.
7:0	PID1	RO	0x00	UART Peripheral ID Register[15:8] Can be used by software to identify the presence of this peripheral.

Register 20: UART Peripheral Identification 2 (UARTPeriphID2), offset 0xFE8

The **UARTPeriphIDn** registers are hard-coded and the fields within the registers determine the reset values.

UART Peripheral Identification 2 (UARTPeriphID2)

UART0 base: 0x4000.C000

UART1 base: 0x4000.D000

UART2 base: 0x4000.E000

Offset 0xFE8

Type RO, reset 0x0000.0018

	31	30	29	28	27	26	25	24	23	22	21	20	19	18	17	16
	reserved															
Type	RO	RO	RO	RO	RO	RO	RO	RO	RO	RO	RO	RO	RO	RO	RO	RO
Reset	0	0	0	0	0	0	0	0	0	0	0	0	0	0	0	0
	15	14	13	12	11	10	9	8	7	6	5	4	3	2	1	0
	reserved								PID2							
Type	RO	RO	RO	RO	RO	RO	RO	RO	RO	RO	RO	RO	RO	RO	RO	RO
Reset	0	0	0	0	0	0	0	0	0	0	0	1	1	0	0	0

Bit/Field	Name	Type	Reset	Description
31:8	reserved	RO	0x00	Software should not rely on the value of a reserved bit. To provide compatibility with future products, the value of a reserved bit should be preserved across a read-modify-write operation.
7:0	PID2	RO	0x18	UART Peripheral ID Register[23:16] Can be used by software to identify the presence of this peripheral.

Register 21: UART Peripheral Identification 3 (UARTPeriphID3), offset 0xFEC

The **UARTPeriphIDn** registers are hard-coded and the fields within the registers determine the reset values.

UART Peripheral Identification 3 (UARTPeriphID3)

UART0 base: 0x4000.C000

UART1 base: 0x4000.D000

UART2 base: 0x4000.E000

Offset 0xFEC

Type RO, reset 0x0000.0001

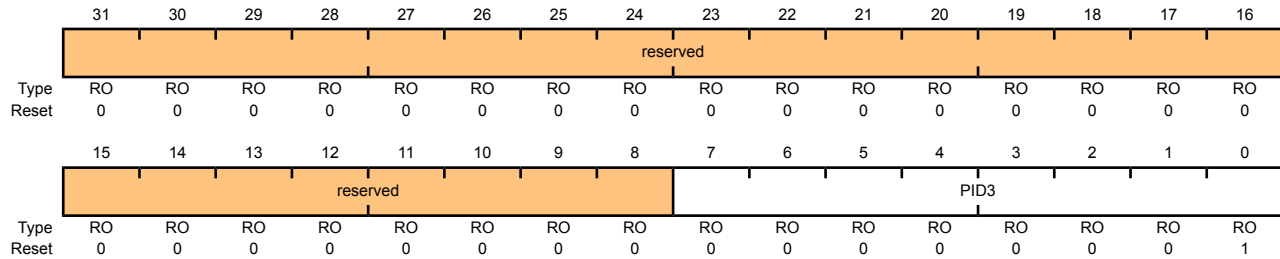

Bit/Field	Name	Type	Reset	Description
31:8	reserved	RO	0x00	Software should not rely on the value of a reserved bit. To provide compatibility with future products, the value of a reserved bit should be preserved across a read-modify-write operation.
7:0	PID3	RO	0x01	UART Peripheral ID Register[31:24] Can be used by software to identify the presence of this peripheral.

Register 22: UART PrimeCell Identification 0 (UARTPCellID0), offset 0xFF0

The **UARTPCellIDn** registers are hard-coded and the fields within the registers determine the reset values.

UART PrimeCell Identification 0 (UARTPCellID0)

UART0 base: 0x4000.C000
 UART1 base: 0x4000.D000
 UART2 base: 0x4000.E000
 Offset 0xFF0
 Type RO, reset 0x0000.000D

	31	30	29	28	27	26	25	24	23	22	21	20	19	18	17	16
	reserved															
Type	RO	RO	RO	RO	RO	RO	RO	RO	RO	RO	RO	RO	RO	RO	RO	RO
Reset	0	0	0	0	0	0	0	0	0	0	0	0	0	0	0	0
	15	14	13	12	11	10	9	8	7	6	5	4	3	2	1	0
	reserved								CID0							
Type	RO	RO	RO	RO	RO	RO	RO	RO	RO	RO	RO	RO	RO	RO	RO	RO
Reset	0	0	0	0	0	0	0	0	0	0	0	0	1	1	0	1

Bit/Field	Name	Type	Reset	Description
31:8	reserved	RO	0x00	Software should not rely on the value of a reserved bit. To provide compatibility with future products, the value of a reserved bit should be preserved across a read-modify-write operation.
7:0	CID0	RO	0x0D	UART PrimeCell ID Register[7:0] Provides software a standard cross-peripheral identification system.

Register 23: UART PrimeCell Identification 1 (UARTPCelIID1), offset 0xFF4

The **UARTPCelIIDn** registers are hard-coded and the fields within the registers determine the reset values.

UART PrimeCell Identification 1 (UARTPCelIID1)

UART0 base: 0x4000.C000
 UART1 base: 0x4000.D000
 UART2 base: 0x4000.E000
 Offset 0xFF4
 Type RO, reset 0x0000.00F0

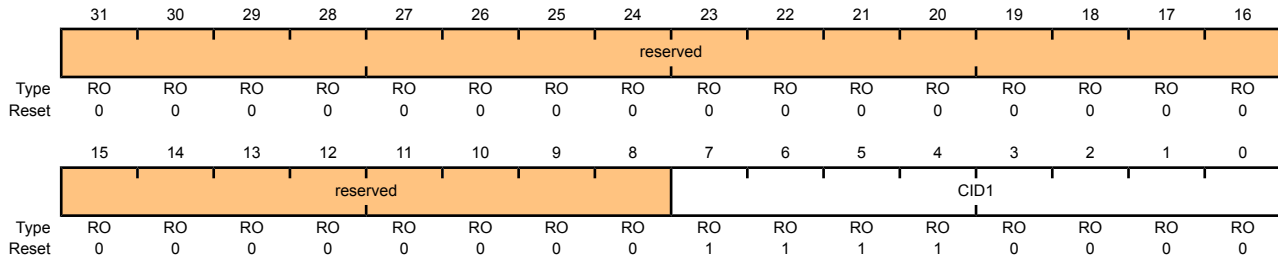

Bit/Field	Name	Type	Reset	Description
31:8	reserved	RO	0x00	Software should not rely on the value of a reserved bit. To provide compatibility with future products, the value of a reserved bit should be preserved across a read-modify-write operation.
7:0	CID1	RO	0xF0	UART PrimeCell ID Register[15:8] Provides software a standard cross-peripheral identification system.

Register 24: UART PrimeCell Identification 2 (UARTPCelIID2), offset 0xFF8

The **UARTPCelIIDn** registers are hard-coded and the fields within the registers determine the reset values.

UART PrimeCell Identification 2 (UARTPCelIID2)

UART0 base: 0x4000.C000
 UART1 base: 0x4000.D000
 UART2 base: 0x4000.E000
 Offset 0xFF8
 Type RO, reset 0x0000.0005

	31	30	29	28	27	26	25	24	23	22	21	20	19	18	17	16
	reserved															
Type	RO	RO	RO	RO	RO	RO	RO	RO	RO	RO	RO	RO	RO	RO	RO	RO
Reset	0	0	0	0	0	0	0	0	0	0	0	0	0	0	0	0
	15	14	13	12	11	10	9	8	7	6	5	4	3	2	1	0
	reserved								CID2							
Type	RO	RO	RO	RO	RO	RO	RO	RO	RO	RO	RO	RO	RO	RO	RO	RO
Reset	0	0	0	0	0	0	0	0	0	0	0	0	0	1	0	1

Bit/Field	Name	Type	Reset	Description
31:8	reserved	RO	0x00	Software should not rely on the value of a reserved bit. To provide compatibility with future products, the value of a reserved bit should be preserved across a read-modify-write operation.
7:0	CID2	RO	0x05	UART PrimeCell ID Register[23:16] Provides software a standard cross-peripheral identification system.

Register 25: UART PrimeCell Identification 3 (UARTPCelIID3), offset 0xFFC

The **UARTPCelIIDn** registers are hard-coded and the fields within the registers determine the reset values.

UART PrimeCell Identification 3 (UARTPCelIID3)

UART0 base: 0x4000.C000
 UART1 base: 0x4000.D000
 UART2 base: 0x4000.E000
 Offset 0xFFC
 Type RO, reset 0x0000.00B1

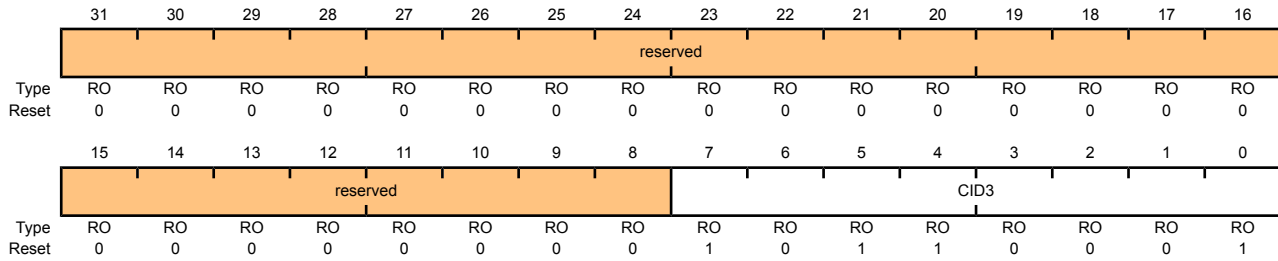

Bit/Field	Name	Type	Reset	Description
31:8	reserved	RO	0x00	Software should not rely on the value of a reserved bit. To provide compatibility with future products, the value of a reserved bit should be preserved across a read-modify-write operation.
7:0	CID3	RO	0xB1	UART PrimeCell ID Register[31:24] Provides software a standard cross-peripheral identification system.

14 Synchronous Serial Interface (SSI)

The Stellaris[®] Synchronous Serial Interface (SSI) is a master or slave interface for synchronous serial communication with peripheral devices that have either Freescale SPI, MICROWIRE, or Texas Instruments synchronous serial interfaces.

The Stellaris[®] SSI module has the following features:

- Master or slave operation
- Programmable clock bit rate and prescale
- Separate transmit and receive FIFOs, 16 bits wide, 8 locations deep
- Programmable interface operation for Freescale SPI, MICROWIRE, or Texas Instruments synchronous serial interfaces
- Programmable data frame size from 4 to 16 bits
- Internal loopback test mode for diagnostic/debug testing

14.1 Block Diagram

Figure 14-1. SSI Module Block Diagram

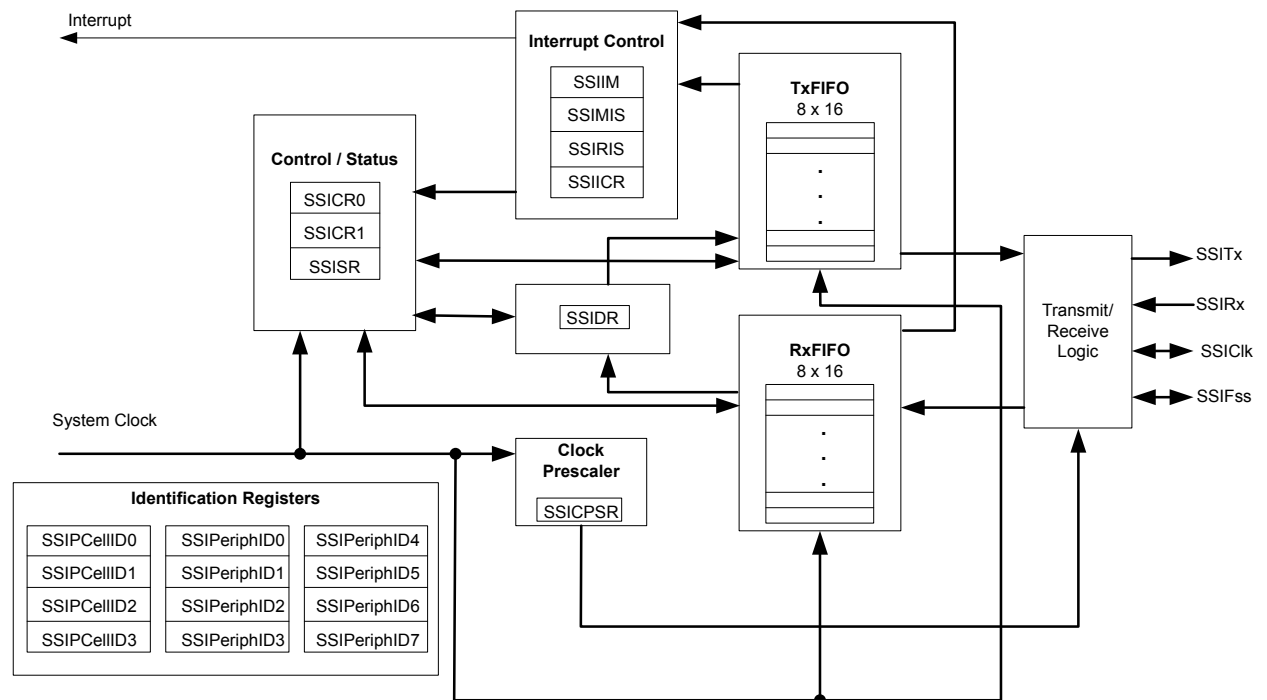

14.2 Functional Description

The SSI performs serial-to-parallel conversion on data received from a peripheral device. The CPU accesses data, control, and status information. The transmit and receive paths are buffered with

internal FIFO memories allowing up to eight 16-bit values to be stored independently in both transmit and receive modes.

14.2.1 Bit Rate Generation

The SSI includes a programmable bit rate clock divider and prescaler to generate the serial output clock. Bit rates are supported to 2 MHz and higher, although maximum bit rate is determined by peripheral devices.

The serial bit rate is derived by dividing down the 50-MHz input clock. The clock is first divided by an even prescale value `CPSDVSR` from 2 to 254, which is programmed in the **SSI Clock Prescale (SSICPSR)** register (see page 348). The clock is further divided by a value from 1 to 256, which is $1 + SCR$, where `SCR` is the value programmed in the **SSI Control0 (SSICR0)** register (see page 341).

The frequency of the output clock `SSIClk` is defined by:

$$f_{SSIClk} = f_{SysClk} / (CPSDVSR * (1 + SCR))$$

Note that although the `SSIClk` transmit clock can theoretically be 25 MHz, the module may not be able to operate at that speed. For master mode, the system clock must be at least two times faster than the `SSIClk`. For slave mode, the system clock must be at least 12 times faster than the `SSIClk`.

See “Synchronous Serial Interface (SSI)” on page 504 to view SSI timing parameters.

14.2.2 FIFO Operation

14.2.2.1 Transmit FIFO

The common transmit FIFO is a 16-bit wide, 8-locations deep, first-in, first-out memory buffer. The CPU writes data to the FIFO by writing the **SSI Data (SSIDR)** register (see page 345), and data is stored in the FIFO until it is read out by the transmission logic.

When configured as a master or a slave, parallel data is written into the transmit FIFO prior to serial conversion and transmission to the attached slave or master, respectively, through the `SSITx` pin.

14.2.2.2 Receive FIFO

The common receive FIFO is a 16-bit wide, 8-locations deep, first-in, first-out memory buffer. Received data from the serial interface is stored in the buffer until read out by the CPU, which accesses the read FIFO by reading the **SSIDR** register.

When configured as a master or slave, serial data received through the `SSIRx` pin is registered prior to parallel loading into the attached slave or master receive FIFO, respectively.

14.2.3 Interrupts

The SSI can generate interrupts when the following conditions are observed:

- Transmit FIFO service
- Receive FIFO service
- Receive FIFO time-out
- Receive FIFO overrun

All of the interrupt events are ORed together before being sent to the interrupt controller, so the SSI can only generate a single interrupt request to the controller at any given time. You can mask each

of the four individual maskable interrupts by setting the appropriate bits in the **SSI Interrupt Mask (SSIIM)** register (see page 349). Setting the appropriate mask bit to 1 enables the interrupt.

Provision of the individual outputs, as well as a combined interrupt output, allows use of either a global interrupt service routine, or modular device drivers to handle interrupts. The transmit and receive dynamic dataflow interrupts have been separated from the status interrupts so that data can be read or written in response to the FIFO trigger levels. The status of the individual interrupt sources can be read from the **SSI Raw Interrupt Status (SSIRIS)** and **SSI Masked Interrupt Status (SSIMIS)** registers (see page 351 and page 352, respectively).

14.2.4 Frame Formats

Each data frame is between 4 and 16 bits long, depending on the size of data programmed, and is transmitted starting with the MSB. There are three basic frame types that can be selected:

- Texas Instruments synchronous serial
- Freescale SPI
- MICROWIRE

For all three formats, the serial clock ($SSIClk$) is held inactive while the SSI is idle, and $SSIClk$ transitions at the programmed frequency only during active transmission or reception of data. The idle state of $SSIClk$ is utilized to provide a receive timeout indication that occurs when the receive FIFO still contains data after a timeout period.

For Freescale SPI and MICROWIRE frame formats, the serial frame ($SSIFss$) pin is active Low, and is asserted (pulled down) during the entire transmission of the frame.

For Texas Instruments synchronous serial frame format, the $SSIFss$ pin is pulsed for one serial clock period starting at its rising edge, prior to the transmission of each frame. For this frame format, both the SSI and the off-chip slave device drive their output data on the rising edge of $SSIClk$, and latch data from the other device on the falling edge.

Unlike the full-duplex transmission of the other two frame formats, the MICROWIRE format uses a special master-slave messaging technique, which operates at half-duplex. In this mode, when a frame begins, an 8-bit control message is transmitted to the off-chip slave. During this transmit, no incoming data is received by the SSI. After the message has been sent, the off-chip slave decodes it and, after waiting one serial clock after the last bit of the 8-bit control message has been sent, responds with the requested data. The returned data can be 4 to 16 bits in length, making the total frame length anywhere from 13 to 25 bits.

14.2.4.1 Texas Instruments Synchronous Serial Frame Format

Figure 14-2 on page 331 shows the Texas Instruments synchronous serial frame format for a single transmitted frame.

Figure 14-2. TI Synchronous Serial Frame Format (Single Transfer)

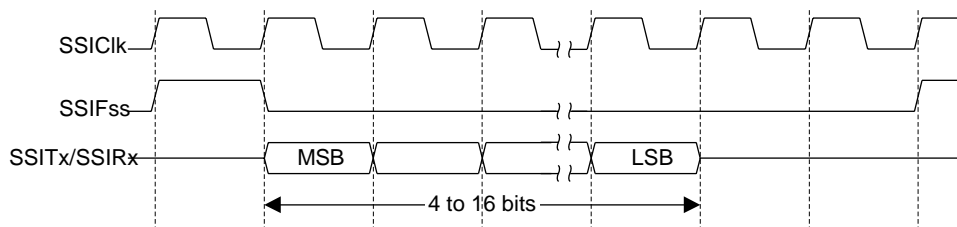

In this mode, $SSIClk$ and $SSIFss$ are forced Low, and the transmit data line $SSITx$ is tristated whenever the SSI is idle. Once the bottom entry of the transmit FIFO contains data, $SSIFss$ is pulsed High for one $SSIClk$ period. The value to be transmitted is also transferred from the transmit FIFO to the serial shift register of the transmit logic. On the next rising edge of $SSIClk$, the MSB of the 4 to 16-bit data frame is shifted out on the $SSITx$ pin. Likewise, the MSB of the received data is shifted onto the $SSIRx$ pin by the off-chip serial slave device.

Both the SSI and the off-chip serial slave device then clock each data bit into their serial shifter on the falling edge of each $SSIClk$. The received data is transferred from the serial shifter to the receive FIFO on the first rising edge of $SSIClk$ after the LSB has been latched.

Figure 14-3 on page 332 shows the Texas Instruments synchronous serial frame format when back-to-back frames are transmitted.

Figure 14-3. TI Synchronous Serial Frame Format (Continuous Transfer)

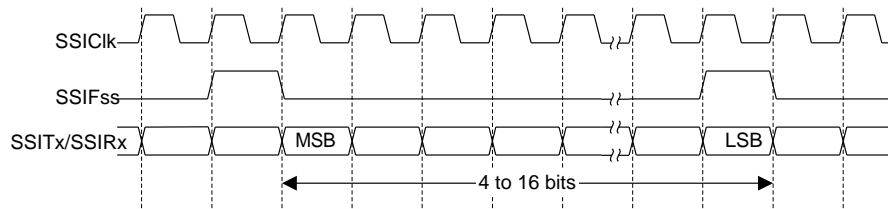

14.2.4.2 Freescale SPI Frame Format

The Freescale SPI interface is a four-wire interface where the $SSIFss$ signal behaves as a slave select. The main feature of the Freescale SPI format is that the inactive state and phase of the $SSIClk$ signal are programmable through the SPO and SPH bits within the **SSISCR0** control register.

SPO Clock Polarity Bit

When the SPO clock polarity control bit is Low, it produces a steady state Low value on the $SSIClk$ pin. If the SPO bit is High, a steady state High value is placed on the $SSIClk$ pin when data is not being transferred.

SPH Phase Control Bit

The SPH phase control bit selects the clock edge that captures data and allows it to change state. It has the most impact on the first bit transmitted by either allowing or not allowing a clock transition before the first data capture edge. When the SPH phase control bit is Low, data is captured on the first clock edge transition. If the SPH bit is High, data is captured on the second clock edge transition.

14.2.4.3 Freescale SPI Frame Format with $SPO=0$ and $SPH=0$

Single and continuous transmission signal sequences for Freescale SPI format with $SPO=0$ and $SPH=0$ are shown in Figure 14-4 on page 333 and Figure 14-5 on page 333.

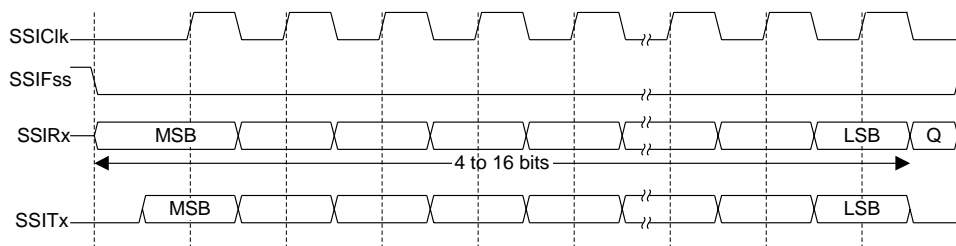
Figure 14-4. Freescale SPI Format (Single Transfer) with SPO=0 and SPH=0

Note: Q is undefined.

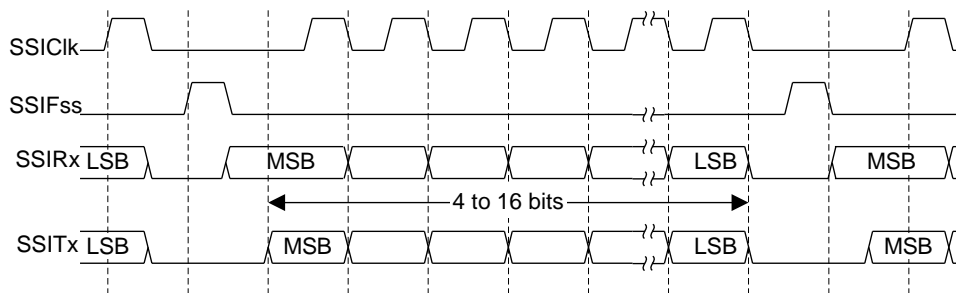
Figure 14-5. Freescale SPI Format (Continuous Transfer) with SPO=0 and SPH=0

In this configuration, during idle periods:

- SSIClk is forced Low
- SSIFss is forced High
- The transmit data line SSITx is arbitrarily forced Low
- When the SSI is configured as a master, it enables the SSIClk pad
- When the SSI is configured as a slave, it disables the SSIClk pad

If the SSI is enabled and there is valid data within the transmit FIFO, the start of transmission is signified by the SSIFss master signal being driven Low. This causes slave data to be enabled onto the SSIRx input line of the master. The master SSITx output pad is enabled.

One half SSIClk period later, valid master data is transferred to the SSITx pin. Now that both the master and slave data have been set, the SSIClk master clock pin goes High after one further half SSIClk period.

The data is now captured on the rising and propagated on the falling edges of the SSIClk signal.

In the case of a single word transmission, after all bits of the data word have been transferred, the SSIFss line is returned to its idle High state one SSIClk period after the last bit has been captured.

However, in the case of continuous back-to-back transmissions, the SSIFss signal must be pulsed High between each data word transfer. This is because the slave select pin freezes the data in its serial peripheral register and does not allow it to be altered if the SPH bit is logic zero. Therefore, the master device must raise the SSIFss pin of the slave device between each data transfer to enable the serial peripheral data write. On completion of the continuous transfer, the SSIFss pin is returned to its idle state one SSIClk period after the last bit has been captured.

14.2.4.4 Freescale SPI Frame Format with SPO=0 and SPH=1

The transfer signal sequence for Freescale SPI format with SPO=0 and SPH=1 is shown in Figure 14-6 on page 334, which covers both single and continuous transfers.

Figure 14-6. Freescale SPI Frame Format with SPO=0 and SPH=1

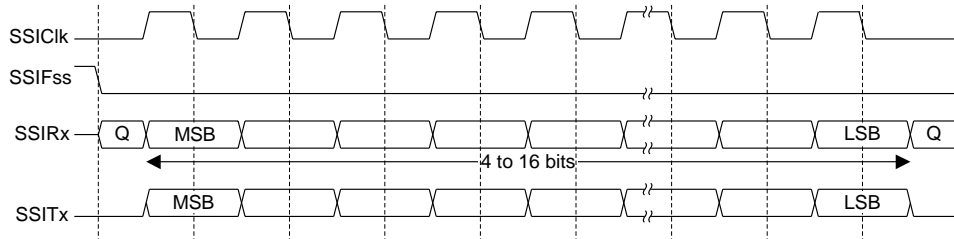

Note: Q is undefined.

In this configuration, during idle periods:

- SSIClk is forced Low
- SSIFss is forced High
- The transmit data line SSITx is arbitrarily forced Low
- When the SSI is configured as a master, it enables the SSIClk pad
- When the SSI is configured as a slave, it disables the SSIClk pad

If the SSI is enabled and there is valid data within the transmit FIFO, the start of transmission is signified by the SSIFss master signal being driven Low. The master SSITx output is enabled. After a further one half SSIClk period, both master and slave valid data is enabled onto their respective transmission lines. At the same time, the SSIClk is enabled with a rising edge transition.

Data is then captured on the falling edges and propagated on the rising edges of the SSIClk signal.

In the case of a single word transfer, after all bits have been transferred, the SSIFss line is returned to its idle High state one SSIClk period after the last bit has been captured.

For continuous back-to-back transfers, the SSIFss pin is held Low between successive data words and termination is the same as that of the single word transfer.

14.2.4.5 Freescale SPI Frame Format with SPO=1 and SPH=0

Single and continuous transmission signal sequences for Freescale SPI format with SPO=1 and SPH=0 are shown in Figure 14-7 on page 335 and Figure 14-8 on page 335.

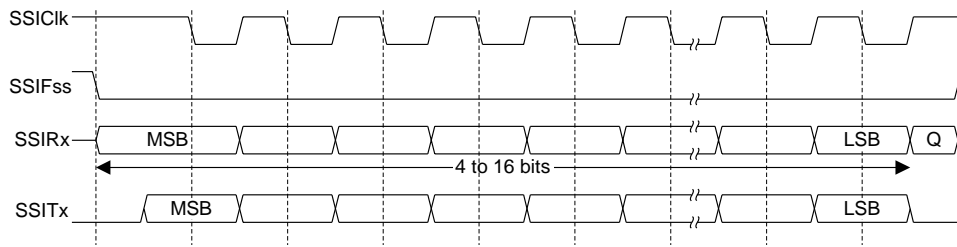
Figure 14-7. Freescale SPI Frame Format (Single Transfer) with SPO=1 and SPH=0

Note: Q is undefined.

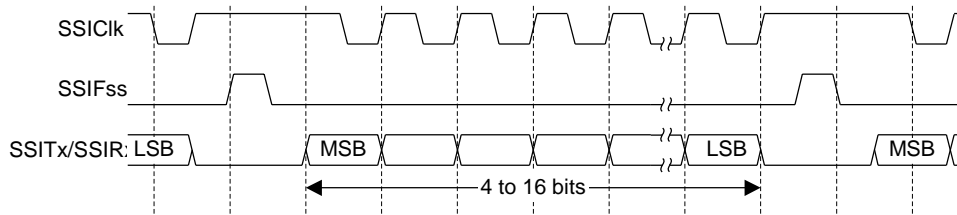
Figure 14-8. Freescale SPI Frame Format (Continuous Transfer) with SPO=1 and SPH=0

In this configuration, during idle periods:

- SSIClk is forced High
- SSIFss is forced High
- The transmit data line SSITx is arbitrarily forced Low
- When the SSI is configured as a master, it enables the SSIClk pad
- When the SSI is configured as a slave, it disables the SSIClk pad

If the SSI is enabled and there is valid data within the transmit FIFO, the start of transmission is signified by the SSIFss master signal being driven Low, which causes slave data to be immediately transferred onto the SSIRx line of the master. The master SSITx output pad is enabled.

One half period later, valid master data is transferred to the SSITx line. Now that both the master and slave data have been set, the SSIClk master clock pin becomes Low after one further half SSIClk period. This means that data is captured on the falling edges and propagated on the rising edges of the SSIClk signal.

In the case of a single word transmission, after all bits of the data word are transferred, the SSIFss line is returned to its idle High state one SSIClk period after the last bit has been captured.

However, in the case of continuous back-to-back transmissions, the SSIFss signal must be pulsed High between each data word transfer. This is because the slave select pin freezes the data in its serial peripheral register and does not allow it to be altered if the SPH bit is logic zero. Therefore, the master device must raise the SSIFss pin of the slave device between each data transfer to enable the serial peripheral data write. On completion of the continuous transfer, the SSIFss pin is returned to its idle state one SSIClk period after the last bit has been captured.

14.2.4.6 Freescale SPI Frame Format with SPO=1 and SPH=1

The transfer signal sequence for Freescale SPI format with SPO=1 and SPH=1 is shown in Figure 14-9 on page 336, which covers both single and continuous transfers.

Figure 14-9. Freescale SPI Frame Format with SPO=1 and SPH=1

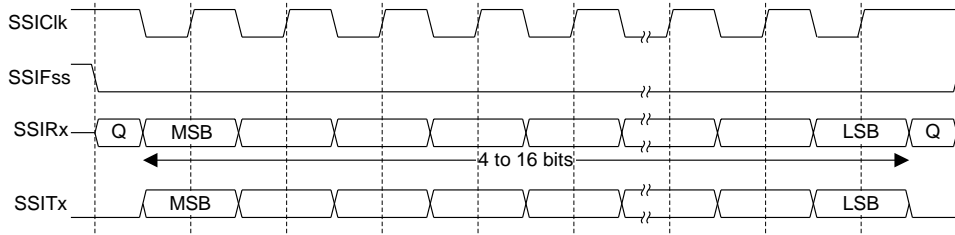

Note: Q is undefined.

In this configuration, during idle periods:

- SSIClk is forced High
- SSIFss is forced High
- The transmit data line SSITx is arbitrarily forced Low
- When the SSI is configured as a master, it enables the SSIClk pad
- When the SSI is configured as a slave, it disables the SSIClk pad

If the SSI is enabled and there is valid data within the transmit FIFO, the start of transmission is signified by the SSIFss master signal being driven Low. The master SSITx output pad is enabled. After a further one-half SSIClk period, both master and slave data are enabled onto their respective transmission lines. At the same time, SSIClk is enabled with a falling edge transition. Data is then captured on the rising edges and propagated on the falling edges of the SSIClk signal.

After all bits have been transferred, in the case of a single word transmission, the SSIFss line is returned to its idle high state one SSIClk period after the last bit has been captured.

For continuous back-to-back transmissions, the SSIFss pin remains in its active Low state, until the final bit of the last word has been captured, and then returns to its idle state as described above.

For continuous back-to-back transfers, the SSIFss pin is held Low between successive data words and termination is the same as that of the single word transfer.

14.2.4.7 MICROWIRE Frame Format

Figure 14-10 on page 337 shows the MICROWIRE frame format, again for a single frame. Figure 14-11 on page 338 shows the same format when back-to-back frames are transmitted.

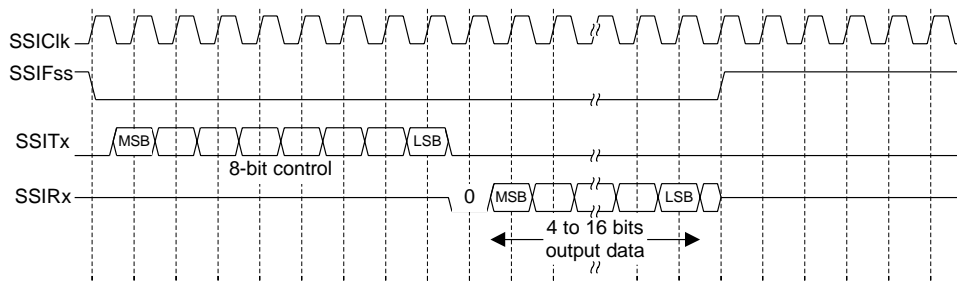
Figure 14-10. MICROWIRE Frame Format (Single Frame)

MICROWIRE format is very similar to SPI format, except that transmission is half-duplex instead of full-duplex, using a master-slave message passing technique. Each serial transmission begins with an 8-bit control word that is transmitted from the SSI to the off-chip slave device. During this transmission, no incoming data is received by the SSI. After the message has been sent, the off-chip slave decodes it and, after waiting one serial clock after the last bit of the 8-bit control message has been sent, responds with the required data. The returned data is 4 to 16 bits in length, making the total frame length anywhere from 13 to 25 bits.

In this configuration, during idle periods:

- SSIClk is forced Low
- SSIFss is forced High
- The transmit data line SSITx is arbitrarily forced Low

A transmission is triggered by writing a control byte to the transmit FIFO. The falling edge of SSIFss causes the value contained in the bottom entry of the transmit FIFO to be transferred to the serial shift register of the transmit logic, and the MSB of the 8-bit control frame to be shifted out onto the SSITx pin. SSIFss remains Low for the duration of the frame transmission. The SSIRx pin remains tristated during this transmission.

The off-chip serial slave device latches each control bit into its serial shifter on the rising edge of each SSIClk. After the last bit is latched by the slave device, the control byte is decoded during a one clock wait-state, and the slave responds by transmitting data back to the SSI. Each bit is driven onto the SSIRx line on the falling edge of SSIClk. The SSI in turn latches each bit on the rising edge of SSIClk. At the end of the frame, for single transfers, the SSIFss signal is pulled High one clock period after the last bit has been latched in the receive serial shifter, which causes the data to be transferred to the receive FIFO.

Note: The off-chip slave device can tristate the receive line either on the falling edge of SSIClk after the LSB has been latched by the receive shifter, or when the SSIFss pin goes High.

For continuous transfers, data transmission begins and ends in the same manner as a single transfer. However, the SSIFss line is continuously asserted (held Low) and transmission of data occurs back-to-back. The control byte of the next frame follows directly after the LSB of the received data from the current frame. Each of the received values is transferred from the receive shifter on the falling edge of SSIClk, after the LSB of the frame has been latched into the SSI.

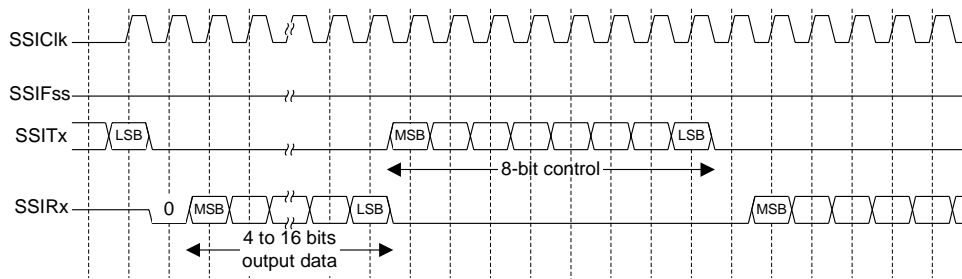
Figure 14-11. MICROWIRE Frame Format (Continuous Transfer)

In the MICROWIRE mode, the SSI slave samples the first bit of receive data on the rising edge of SSIClk after SSIFss has gone Low. Masters that drive a free-running SSIClk must ensure that the SSIFss signal has sufficient setup and hold margins with respect to the rising edge of SSIClk.

Figure 14-12 on page 338 illustrates these setup and hold time requirements. With respect to the SSIClk rising edge on which the first bit of receive data is to be sampled by the SSI slave, SSIFss must have a setup of at least two times the period of SSIClk. With respect to the SSIClk rising edge previous to this edge, SSIFss must have a hold of at least one SSIClk period.

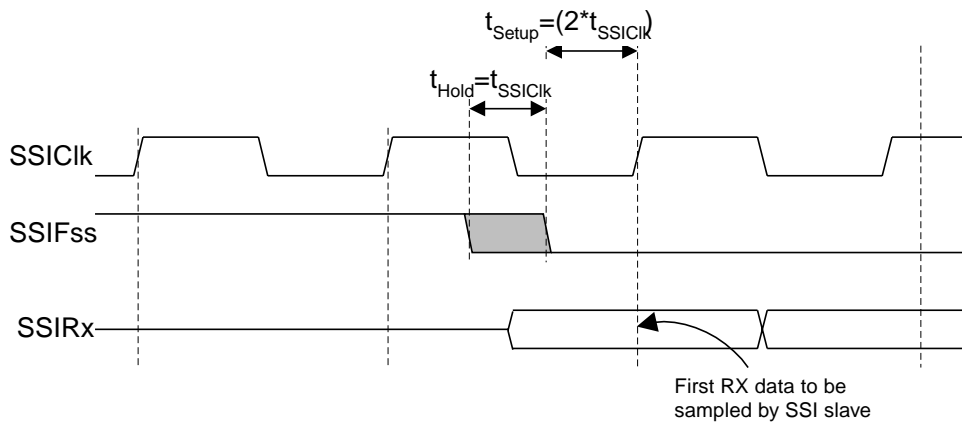
Figure 14-12. MICROWIRE Frame Format, SSIFss Input Setup and Hold Requirements

14.3 Initialization and Configuration

To use the SSI, its peripheral clock must be enabled by setting the SSI bit in the RCGC1 register.

For each of the frame formats, the SSI is configured using the following steps:

1. Ensure that the SSE bit in the SSICR1 register is disabled before making any configuration changes.
2. Select whether the SSI is a master or slave:
 - a. For master operations, set the SSICR1 register to 0x0000.0000.
 - b. For slave mode (output enabled), set the SSICR1 register to 0x0000.0004.
 - c. For slave mode (output disabled), set the SSICR1 register to 0x0000.000C.
3. Configure the clock prescale divisor by writing the SSICPSR register.

4. Write the **SSICR0** register with the following configuration:
 - Serial clock rate (*SCR*)
 - Desired clock phase/polarity, if using Freescale SPI mode (*SPH* and *SPO*)
 - The protocol mode: Freescale SPI, TI SSF, MICROWIRE (*FRF*)
 - The data size (*DSS*)
5. Enable the SSI by setting the *SSE* bit in the **SSICR1** register.

As an example, assume the SSI must be configured to operate with the following parameters:

- Master operation
- Freescale SPI mode (*SPO*=1, *SPH*=1)
- 1 Mbps bit rate
- 8 data bits

Assuming the system clock is 20 MHz, the bit rate calculation would be:

$$F_{SSIClk} = F_{SysClk} / (CPSDVSR * (1 + SCR))$$

$$1 \times 10^6 = 20 \times 10^6 / (CPSDVSR * (1 + SCR))$$

In this case, if *CPSDVSR*=2, *SCR* must be 9.

The configuration sequence would be as follows:

1. Ensure that the *SSE* bit in the **SSICR1** register is disabled.
2. Write the **SSICR1** register with a value of 0x0000.0000.
3. Write the **SSICPSR** register with a value of 0x0000.0002.
4. Write the **SSICR0** register with a value of 0x0000.09C7.
5. The SSI is then enabled by setting the *SSE* bit in the **SSICR1** register to 1.

14.4 Register Map

Table 14-1 on page 339 lists the SSI registers. The offset listed is a hexadecimal increment to the register's address, relative to that SSI module's base address:

- SSI0: 0x4000.8000

Note: The SSI must be disabled (see the *SSE* bit in the **SSICR1** register) before any of the control registers are reprogrammed.

Table 14-1. SSI Register Map

Offset	Name	Type	Reset	Description	See page
0x000	SSICR0	R/W	0x0000.0000	SSI Control 0	341

Offset	Name	Type	Reset	Description	See page
0x004	SSICR1	R/W	0x0000.0000	SSI Control 1	343
0x008	SSIDR	R/W	0x0000.0000	SSI Data	345
0x00C	SSISR	RO	0x0000.0003	SSI Status	346
0x010	SSICPSR	R/W	0x0000.0000	SSI Clock Prescale	348
0x014	SSIIM	R/W	0x0000.0000	SSI Interrupt Mask	349
0x018	SSIRIS	RO	0x0000.0008	SSI Raw Interrupt Status	351
0x01C	SSIMIS	RO	0x0000.0000	SSI Masked Interrupt Status	352
0x020	SSIICR	W1C	0x0000.0000	SSI Interrupt Clear	353
0xFD0	SSIPeriphID4	RO	0x0000.0000	SSI Peripheral Identification 4	354
0xFD4	SSIPeriphID5	RO	0x0000.0000	SSI Peripheral Identification 5	355
0xFD8	SSIPeriphID6	RO	0x0000.0000	SSI Peripheral Identification 6	356
0xFDC	SSIPeriphID7	RO	0x0000.0000	SSI Peripheral Identification 7	357
0xFE0	SSIPeriphID0	RO	0x0000.0022	SSI Peripheral Identification 0	358
0xFE4	SSIPeriphID1	RO	0x0000.0000	SSI Peripheral Identification 1	359
0xFE8	SSIPeriphID2	RO	0x0000.0018	SSI Peripheral Identification 2	360
0xFEC	SSIPeriphID3	RO	0x0000.0001	SSI Peripheral Identification 3	361
0xFF0	SSIPCellID0	RO	0x0000.000D	SSI PrimeCell Identification 0	362
0xFF4	SSIPCellID1	RO	0x0000.00F0	SSI PrimeCell Identification 1	363
0xFF8	SSIPCellID2	RO	0x0000.0005	SSI PrimeCell Identification 2	364
0xFFC	SSIPCellID3	RO	0x0000.00B1	SSI PrimeCell Identification 3	365

14.5 Register Descriptions

The remainder of this section lists and describes the SSI registers, in numerical order by address offset.

Register 1: SSI Control 0 (SSICR0), offset 0x000

SSICR0 is control register 0 and contains bit fields that control various functions within the SSI module. Functionality such as protocol mode, clock rate, and data size are configured in this register.

SSI Control 0 (SSICR0)

SSI0 base: 0x4000.8000
Offset 0x000
Type R/W, reset 0x0000.0000

	31	30	29	28	27	26	25	24	23	22	21	20	19	18	17	16
	reserved															
Type	RO	RO	RO	RO	RO	RO	RO	RO	RO	RO	RO	RO	RO	RO	RO	RO
Reset	0	0	0	0	0	0	0	0	0	0	0	0	0	0	0	0
	15	14	13	12	11	10	9	8	7	6	5	4	3	2	1	0
	SCR								SPH		SPO		FRF		DSS	
Type	R/W	R/W	R/W	R/W	R/W	R/W	R/W	R/W	R/W	R/W	R/W	R/W	R/W	R/W	R/W	R/W
Reset	0	0	0	0	0	0	0	0	0	0	0	0	0	0	0	0

Bit/Field	Name	Type	Reset	Description
31:16	reserved	RO	0x00	Software should not rely on the value of a reserved bit. To provide compatibility with future products, the value of a reserved bit should be preserved across a read-modify-write operation.
15:8	SCR	R/W	0x0000	SSI Serial Clock Rate The value <code>SCR</code> is used to generate the transmit and receive bit rate of the SSI. The bit rate is: $BR = F_{SSIClk} / (CPSDVSR * (1 + SCR))$ where <code>CPSDVSR</code> is an even value from 2-254 programmed in the SSICPSR register, and <code>SCR</code> is a value from 0-255.
7	SPH	R/W	0	SSI Serial Clock Phase This bit is only applicable to the Freescale SPI Format. The <code>SPH</code> control bit selects the clock edge that captures data and allows it to change state. It has the most impact on the first bit transmitted by either allowing or not allowing a clock transition before the first data capture edge. When the <code>SPH</code> bit is 0, data is captured on the first clock edge transition. If <code>SPH</code> is 1, data is captured on the second clock edge transition.
6	SPO	R/W	0	SSI Serial Clock Polarity This bit is only applicable to the Freescale SPI Format. When the <code>SPO</code> bit is 0, it produces a steady state Low value on the <code>SSIClk</code> pin. If <code>SPO</code> is 1, a steady state High value is placed on the <code>SSIClk</code> pin when data is not being transferred.

Bit/Field	Name	Type	Reset	Description
5:4	FRF	R/W	0x0	SSI Frame Format Select The FRF values are defined as follows: Value Frame Format 0x0 Freescale SPI Frame Format 0x1 Texas Instruments Synchronous Serial Frame Format 0x2 MICROWIRE Frame Format 0x3 Reserved
3:0	DSS	R/W	0x00	SSI Data Size Select The DSS values are defined as follows: Value Data Size 0x0-0x2 Reserved 0x3 4-bit data 0x4 5-bit data 0x5 6-bit data 0x6 7-bit data 0x7 8-bit data 0x8 9-bit data 0x9 10-bit data 0xA 11-bit data 0xB 12-bit data 0xC 13-bit data 0xD 14-bit data 0xE 15-bit data 0xF 16-bit data

Register 2: SSI Control 1 (SSICR1), offset 0x004

SSICR1 is control register 1 and contains bit fields that control various functions within the SSI module. Master and slave mode functionality is controlled by this register.

SSI Control 1 (SSICR1)

SSI0 base: 0x4000.8000
Offset 0x004
Type R/W, reset 0x0000.0000

	31	30	29	28	27	26	25	24	23	22	21	20	19	18	17	16	
	reserved																
Type	RO	RO	RO	RO	RO	RO	RO	RO	RO	RO	RO	RO	RO	RO	RO	RO	
Reset	0	0	0	0	0	0	0	0	0	0	0	0	0	0	0	0	
	15	14	13	12	11	10	9	8	7	6	5	4	3	2	1	0	
	reserved												SOD	MS	SSE	LBM	
Type	RO	RO	RO	RO	RO	RO	RO	RO	RO	RO	RO	RO	RO	R/W	R/W	R/W	R/W
Reset	0	0	0	0	0	0	0	0	0	0	0	0	0	0	0	0	0

Bit/Field	Name	Type	Reset	Description
31:4	reserved	RO	0x00	Software should not rely on the value of a reserved bit. To provide compatibility with future products, the value of a reserved bit should be preserved across a read-modify-write operation.
3	SOD	R/W	0	SSI Slave Mode Output Disable This bit is relevant only in the Slave mode ($MS=1$). In multiple-slave systems, it is possible for the SSI master to broadcast a message to all slaves in the system while ensuring that only one slave drives data onto the serial output line. In such systems, the TXD lines from multiple slaves could be tied together. To operate in such a system, the SOD bit can be configured so that the SSI slave does not drive the SSITx pin. The SOD values are defined as follows: Value Description <ul style="list-style-type: none"> 0 SSI can drive SSITx output in Slave Output mode. 1 SSI must not drive the SSITx output in Slave mode.
2	MS	R/W	0	SSI Master/Slave Select This bit selects Master or Slave mode and can be modified only when SSI is disabled ($SSE=0$). The MS values are defined as follows: Value Description <ul style="list-style-type: none"> 0 Device configured as a master. 1 Device configured as a slave.

Bit/Field	Name	Type	Reset	Description						
1	SSE	R/W	0	<p>SSI Synchronous Serial Port Enable</p> <p>Setting this bit enables SSI operation.</p> <p>The <code>SSE</code> values are defined as follows:</p> <table><thead><tr><th>Value</th><th>Description</th></tr></thead><tbody><tr><td>0</td><td>SSI operation disabled.</td></tr><tr><td>1</td><td>SSI operation enabled.</td></tr></tbody></table> <p>Note: This bit must be set to 0 before any control registers are reprogrammed.</p>	Value	Description	0	SSI operation disabled.	1	SSI operation enabled.
Value	Description									
0	SSI operation disabled.									
1	SSI operation enabled.									
0	LBM	R/W	0	<p>SSI Loopback Mode</p> <p>Setting this bit enables Loopback Test mode.</p> <p>The <code>LBM</code> values are defined as follows:</p> <table><thead><tr><th>Value</th><th>Description</th></tr></thead><tbody><tr><td>0</td><td>Normal serial port operation enabled.</td></tr><tr><td>1</td><td>Output of the transmit serial shift register is connected internally to the input of the receive serial shift register.</td></tr></tbody></table>	Value	Description	0	Normal serial port operation enabled.	1	Output of the transmit serial shift register is connected internally to the input of the receive serial shift register.
Value	Description									
0	Normal serial port operation enabled.									
1	Output of the transmit serial shift register is connected internally to the input of the receive serial shift register.									

Register 3: SSI Data (SSIDR), offset 0x008

SSIDR is the data register and is 16-bits wide. When **SSIDR** is read, the entry in the receive FIFO (pointed to by the current FIFO read pointer) is accessed. As data values are removed by the SSI receive logic from the incoming data frame, they are placed into the entry in the receive FIFO (pointed to by the current FIFO write pointer).

When **SSIDR** is written to, the entry in the transmit FIFO (pointed to by the write pointer) is written to. Data values are removed from the transmit FIFO one value at a time by the transmit logic. It is loaded into the transmit serial shifter, then serially shifted out onto the **SSITx** pin at the programmed bit rate.

When a data size of less than 16 bits is selected, the user must right-justify data written to the transmit FIFO. The transmit logic ignores the unused bits. Received data less than 16 bits is automatically right-justified in the receive buffer.

When the SSI is programmed for MICROWIRE frame format, the default size for transmit data is eight bits (the most significant byte is ignored). The receive data size is controlled by the programmer. The transmit FIFO and the receive FIFO are not cleared even when the **SSE** bit in the **SSICR1** register is set to zero. This allows the software to fill the transmit FIFO before enabling the SSI.

SSI Data (SSIDR)

SSI0 base: 0x4000.8000
 Offset 0x008
 Type R/W, reset 0x0000.0000

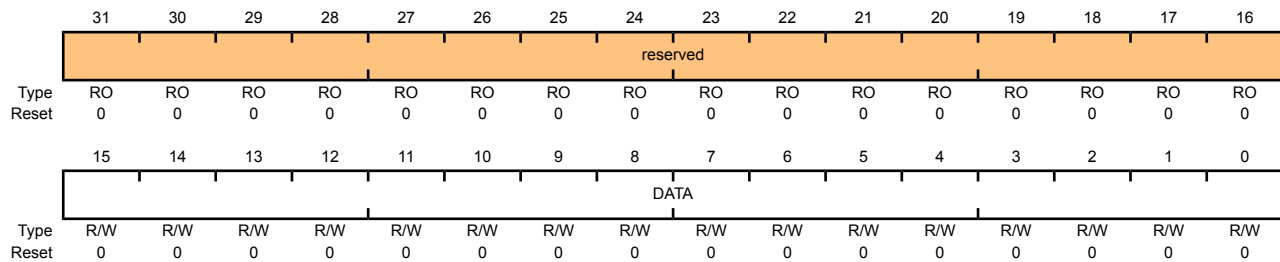

Bit/Field	Name	Type	Reset	Description
31:16	reserved	RO	0x0000	Software should not rely on the value of a reserved bit. To provide compatibility with future products, the value of a reserved bit should be preserved across a read-modify-write operation.
15:0	DATA	R/W	0x0000	SSI Receive/Transmit Data A read operation reads the receive FIFO. A write operation writes the transmit FIFO. Software must right-justify data when the SSI is programmed for a data size that is less than 16 bits. Unused bits at the top are ignored by the transmit logic. The receive logic automatically right-justifies the data.

Register 4: SSI Status (SSISR), offset 0x00C

SSISR is a status register that contains bits that indicate the FIFO fill status and the SSI busy status.

SSI Status (SSISR)

SSI0 base: 0x4000.8000
 Offset 0x00C
 Type RO, reset 0x0000.0003

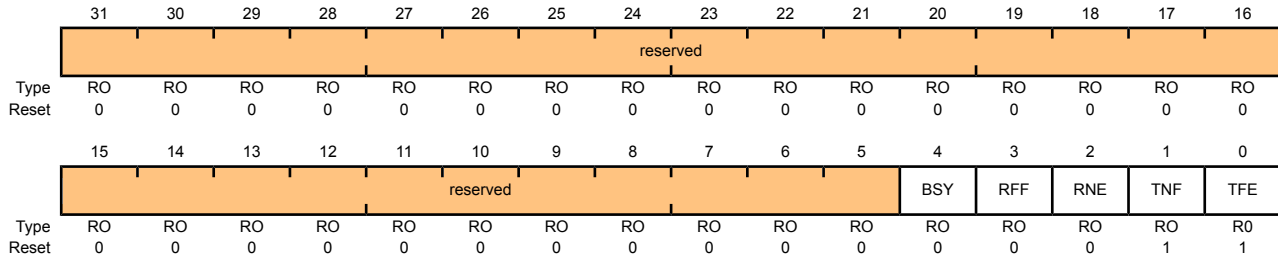

Bit/Field	Name	Type	Reset	Description						
31:5	reserved	RO	0x00	Software should not rely on the value of a reserved bit. To provide compatibility with future products, the value of a reserved bit should be preserved across a read-modify-write operation.						
4	BSY	RO	0	SSI Busy Bit The BSY values are defined as follows: <table border="1"> <thead> <tr> <th>Value</th> <th>Description</th> </tr> </thead> <tbody> <tr> <td>0</td> <td>SSI is idle.</td> </tr> <tr> <td>1</td> <td>SSI is currently transmitting and/or receiving a frame, or the transmit FIFO is not empty.</td> </tr> </tbody> </table>	Value	Description	0	SSI is idle.	1	SSI is currently transmitting and/or receiving a frame, or the transmit FIFO is not empty.
Value	Description									
0	SSI is idle.									
1	SSI is currently transmitting and/or receiving a frame, or the transmit FIFO is not empty.									
3	RFF	RO	0	SSI Receive FIFO Full The RFF values are defined as follows: <table border="1"> <thead> <tr> <th>Value</th> <th>Description</th> </tr> </thead> <tbody> <tr> <td>0</td> <td>Receive FIFO is not full.</td> </tr> <tr> <td>1</td> <td>Receive FIFO is full.</td> </tr> </tbody> </table>	Value	Description	0	Receive FIFO is not full.	1	Receive FIFO is full.
Value	Description									
0	Receive FIFO is not full.									
1	Receive FIFO is full.									
2	RNE	RO	0	SSI Receive FIFO Not Empty The RNE values are defined as follows: <table border="1"> <thead> <tr> <th>Value</th> <th>Description</th> </tr> </thead> <tbody> <tr> <td>0</td> <td>Receive FIFO is empty.</td> </tr> <tr> <td>1</td> <td>Receive FIFO is not empty.</td> </tr> </tbody> </table>	Value	Description	0	Receive FIFO is empty.	1	Receive FIFO is not empty.
Value	Description									
0	Receive FIFO is empty.									
1	Receive FIFO is not empty.									
1	TNF	RO	1	SSI Transmit FIFO Not Full The TNF values are defined as follows: <table border="1"> <thead> <tr> <th>Value</th> <th>Description</th> </tr> </thead> <tbody> <tr> <td>0</td> <td>Transmit FIFO is full.</td> </tr> <tr> <td>1</td> <td>Transmit FIFO is not full.</td> </tr> </tbody> </table>	Value	Description	0	Transmit FIFO is full.	1	Transmit FIFO is not full.
Value	Description									
0	Transmit FIFO is full.									
1	Transmit FIFO is not full.									

Bit/Field	Name	Type	Reset	Description
0	TFE	R0	1	SSI Transmit FIFO Empty The TFE values are defined as follows: Value Description 0 Transmit FIFO is not empty. 1 Transmit FIFO is empty.

Register 5: SSI Clock Prescale (SSICPSR), offset 0x010

SSICPSR is the clock prescale register and specifies the division factor by which the system clock must be internally divided before further use.

The value programmed into this register must be an even number between 2 and 254. The least-significant bit of the programmed number is hard-coded to zero. If an odd number is written to this register, data read back from this register has the least-significant bit as zero.

SSI Clock Prescale (SSICPSR)

SSI0 base: 0x4000.8000
 Offset 0x010
 Type R/W, reset 0x0000.0000

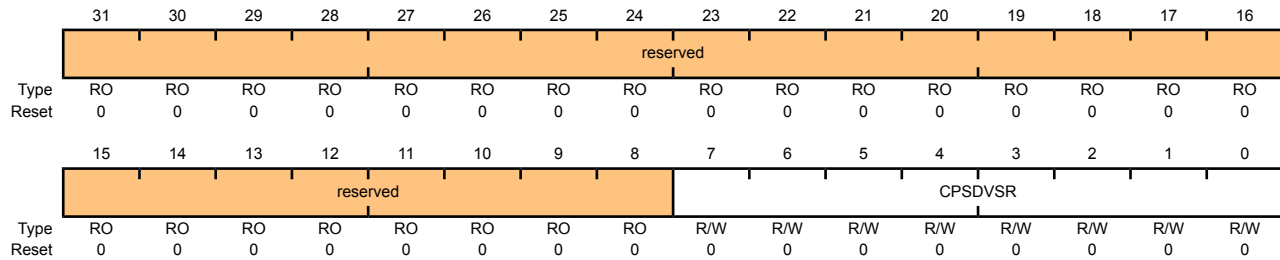

Bit/Field	Name	Type	Reset	Description
31:8	reserved	RO	0x00	Software should not rely on the value of a reserved bit. To provide compatibility with future products, the value of a reserved bit should be preserved across a read-modify-write operation.
7:0	CPSDVSR	R/W	0x00	SSI Clock Prescale Divisor This value must be an even number from 2 to 254, depending on the frequency of SSI _{CLK} . The LSB always returns 0 on reads.

Register 6: SSI Interrupt Mask (SSIIM), offset 0x014

The **SSIIM** register is the interrupt mask set or clear register. It is a read/write register and all bits are cleared to 0 on reset.

On a read, this register gives the current value of the mask on the relevant interrupt. A write of 1 to the particular bit sets the mask, enabling the interrupt to be read. A write of 0 clears the corresponding mask.

SSI Interrupt Mask (SSIIM)

SSI0 base: 0x4000.8000
Offset 0x014
Type R/W, reset 0x0000.0000

	31	30	29	28	27	26	25	24	23	22	21	20	19	18	17	16	
	reserved																
Type	RO	RO	RO	RO	RO	RO	RO	RO	RO	RO	RO	RO	RO	RO	RO	RO	
Reset	0	0	0	0	0	0	0	0	0	0	0	0	0	0	0	0	
	15	14	13	12	11	10	9	8	7	6	5	4	3	2	1	0	
	reserved												TXIM	RXIM	RTIM	RORIM	
Type	RO	RO	RO	RO	RO	RO	RO	RO	RO	RO	RO	RO	RO	R/W	R/W	R/W	R/W
Reset	0	0	0	0	0	0	0	0	0	0	0	0	0	0	0	0	0

Bit/Field	Name	Type	Reset	Description
31:4	reserved	RO	0x00	Software should not rely on the value of a reserved bit. To provide compatibility with future products, the value of a reserved bit should be preserved across a read-modify-write operation.
3	TXIM	R/W	0	SSI Transmit FIFO Interrupt Mask The TXIM values are defined as follows: Value Description 0 TX FIFO half-full or less condition interrupt is masked. 1 TX FIFO half-full or less condition interrupt is not masked.
2	RXIM	R/W	0	SSI Receive FIFO Interrupt Mask The RXIM values are defined as follows: Value Description 0 RX FIFO half-full or more condition interrupt is masked. 1 RX FIFO half-full or more condition interrupt is not masked.
1	RTIM	R/W	0	SSI Receive Time-Out Interrupt Mask The RTIM values are defined as follows: Value Description 0 RX FIFO time-out interrupt is masked. 1 RX FIFO time-out interrupt is not masked.

Bit/Field	Name	Type	Reset	Description
0	RORIM	R/W	0	SSI Receive Overrun Interrupt Mask The RORIM values are defined as follows: Value Description 0 RX FIFO overrun interrupt is masked. 1 RX FIFO overrun interrupt is not masked.

Register 7: SSI Raw Interrupt Status (SSIRIS), offset 0x018

The **SSIRIS** register is the raw interrupt status register. On a read, this register gives the current raw status value of the corresponding interrupt prior to masking. A write has no effect.

SSI Raw Interrupt Status (SSIRIS)

SSI0 base: 0x4000.8000
Offset 0x018
Type RO, reset 0x0000.0008

	31	30	29	28	27	26	25	24	23	22	21	20	19	18	17	16
	reserved															
Type	RO	RO	RO	RO	RO	RO	RO	RO	RO	RO	RO	RO	RO	RO	RO	RO
Reset	0	0	0	0	0	0	0	0	0	0	0	0	0	0	0	0
	15	14	13	12	11	10	9	8	7	6	5	4	3	2	1	0
	reserved												TXRIS	RXRIS	RTRIS	RORRIS
Type	RO	RO	RO	RO	RO	RO	RO	RO	RO	RO	RO	RO	RO	RO	RO	RO
Reset	0	0	0	0	0	0	0	0	0	0	0	0	1	0	0	0

Bit/Field	Name	Type	Reset	Description
31:4	reserved	RO	0x00	Software should not rely on the value of a reserved bit. To provide compatibility with future products, the value of a reserved bit should be preserved across a read-modify-write operation.
3	TXRIS	RO	1	SSI Transmit FIFO Raw Interrupt Status Indicates that the transmit FIFO is half full or less, when set.
2	RXRIS	RO	0	SSI Receive FIFO Raw Interrupt Status Indicates that the receive FIFO is half full or more, when set.
1	RTRIS	RO	0	SSI Receive Time-Out Raw Interrupt Status Indicates that the receive time-out has occurred, when set.
0	RORRIS	RO	0	SSI Receive Overrun Raw Interrupt Status Indicates that the receive FIFO has overflowed, when set.

Register 8: SSI Masked Interrupt Status (SSIMIS), offset 0x01C

The **SSIMIS** register is the masked interrupt status register. On a read, this register gives the current masked status value of the corresponding interrupt. A write has no effect.

SSI Masked Interrupt Status (SSIMIS)

SSI0 base: 0x4000.8000
 Offset 0x01C
 Type RO, reset 0x0000.0000

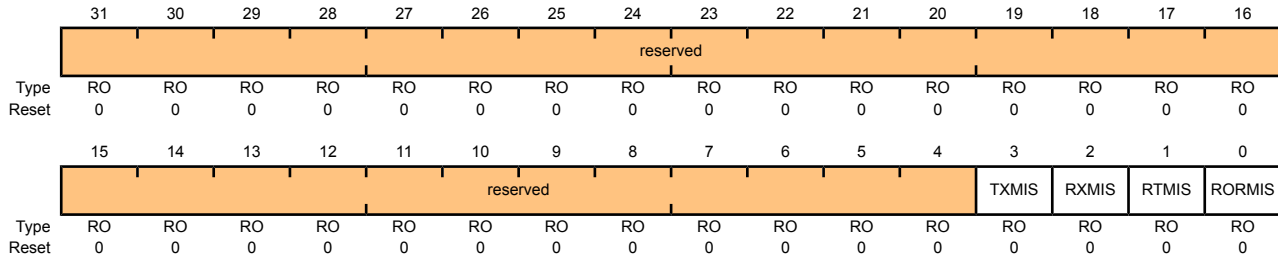

Bit/Field	Name	Type	Reset	Description
31:4	reserved	RO	0	Software should not rely on the value of a reserved bit. To provide compatibility with future products, the value of a reserved bit should be preserved across a read-modify-write operation.
3	TXMIS	RO	0	SSI Transmit FIFO Masked Interrupt Status Indicates that the transmit FIFO is half full or less, when set.
2	RXMIS	RO	0	SSI Receive FIFO Masked Interrupt Status Indicates that the receive FIFO is half full or more, when set.
1	RTMIS	RO	0	SSI Receive Time-Out Masked Interrupt Status Indicates that the receive time-out has occurred, when set.
0	RORMIS	RO	0	SSI Receive Overrun Masked Interrupt Status Indicates that the receive FIFO has overflowed, when set.

Register 9: SSI Interrupt Clear (SSIICR), offset 0x020

The **SSIICR** register is the interrupt clear register. On a write of 1, the corresponding interrupt is cleared. A write of 0 has no effect.

SSI Interrupt Clear (SSIICR)

SSI0 base: 0x4000.8000

Offset 0x020

Type W1C, reset 0x0000.0000

	31	30	29	28	27	26	25	24	23	22	21	20	19	18	17	16	
	reserved																
Type	RO	RO	RO	RO	RO	RO	RO	RO	RO	RO	RO	RO	RO	RO	RO	RO	
Reset	0	0	0	0	0	0	0	0	0	0	0	0	0	0	0	0	
	15	14	13	12	11	10	9	8	7	6	5	4	3	2	1	0	
	reserved														RTIC	RORIC	
Type	RO	RO	RO	RO	RO	RO	RO	RO	RO	RO	RO	RO	RO	RO	RO	W1C	W1C
Reset	0	0	0	0	0	0	0	0	0	0	0	0	0	0	0	0	0

Bit/Field	Name	Type	Reset	Description						
31:2	reserved	RO	0x00	Software should not rely on the value of a reserved bit. To provide compatibility with future products, the value of a reserved bit should be preserved across a read-modify-write operation.						
1	RTIC	W1C	0	SSI Receive Time-Out Interrupt Clear The RTIC values are defined as follows: <table border="1"> <thead> <tr> <th>Value</th> <th>Description</th> </tr> </thead> <tbody> <tr> <td>0</td> <td>No effect on interrupt.</td> </tr> <tr> <td>1</td> <td>Clears interrupt.</td> </tr> </tbody> </table>	Value	Description	0	No effect on interrupt.	1	Clears interrupt.
Value	Description									
0	No effect on interrupt.									
1	Clears interrupt.									
0	RORIC	W1C	0	SSI Receive Overrun Interrupt Clear The RORIC values are defined as follows: <table border="1"> <thead> <tr> <th>Value</th> <th>Description</th> </tr> </thead> <tbody> <tr> <td>0</td> <td>No effect on interrupt.</td> </tr> <tr> <td>1</td> <td>Clears interrupt.</td> </tr> </tbody> </table>	Value	Description	0	No effect on interrupt.	1	Clears interrupt.
Value	Description									
0	No effect on interrupt.									
1	Clears interrupt.									

Register 10: SSI Peripheral Identification 4 (SSIPeriphID4), offset 0xFD0

The **SSIPeriphIDn** registers are hard-coded and the fields within the register determine the reset value.

SSI Peripheral Identification 4 (SSIPeriphID4)

SSI0 base: 0x4000.8000
 Offset 0xFD0
 Type RO, reset 0x0000.0000

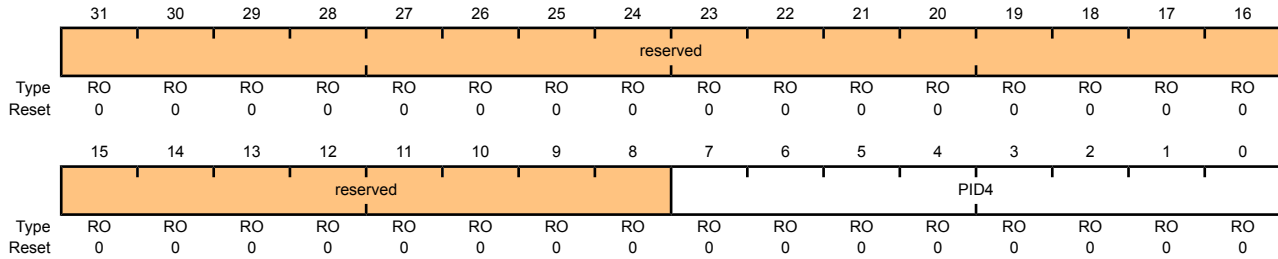

Bit/Field	Name	Type	Reset	Description
31:8	reserved	RO	0x00	Software should not rely on the value of a reserved bit. To provide compatibility with future products, the value of a reserved bit should be preserved across a read-modify-write operation.
7:0	PID4	RO	0x00	SSI Peripheral ID Register[7:0] Can be used by software to identify the presence of this peripheral.

Register 11: SSI Peripheral Identification 5 (SSIPeriphID5), offset 0xFD4

The **SSIPeriphIDn** registers are hard-coded and the fields within the register determine the reset value.

SSI Peripheral Identification 5 (SSIPeriphID5)

SSI0 base: 0x4000.8000

Offset 0xFD4

Type RO, reset 0x0000.0000

	31	30	29	28	27	26	25	24	23	22	21	20	19	18	17	16
	reserved															
Type	RO	RO	RO	RO	RO	RO	RO	RO	RO	RO	RO	RO	RO	RO	RO	RO
Reset	0	0	0	0	0	0	0	0	0	0	0	0	0	0	0	0
	15	14	13	12	11	10	9	8	7	6	5	4	3	2	1	0
	reserved								PID5							
Type	RO	RO	RO	RO	RO	RO	RO	RO	RO	RO	RO	RO	RO	RO	RO	RO
Reset	0	0	0	0	0	0	0	0	0	0	0	0	0	0	0	0

Bit/Field	Name	Type	Reset	Description
31:8	reserved	RO	0x00	Software should not rely on the value of a reserved bit. To provide compatibility with future products, the value of a reserved bit should be preserved across a read-modify-write operation.
7:0	PID5	RO	0x00	SSI Peripheral ID Register[15:8] Can be used by software to identify the presence of this peripheral.

Register 12: SSI Peripheral Identification 6 (SSIPeriphID6), offset 0xFD8

The **SSIPeriphIDn** registers are hard-coded and the fields within the register determine the reset value.

SSI Peripheral Identification 6 (SSIPeriphID6)

SSI0 base: 0x4000.8000
 Offset 0xFD8
 Type RO, reset 0x0000.0000

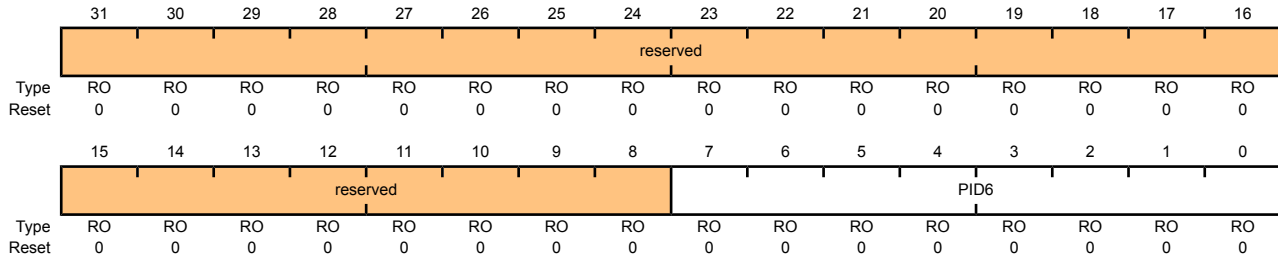

Bit/Field	Name	Type	Reset	Description
31:8	reserved	RO	0x00	Software should not rely on the value of a reserved bit. To provide compatibility with future products, the value of a reserved bit should be preserved across a read-modify-write operation.
7:0	PID6	RO	0x00	SSI Peripheral ID Register[23:16] Can be used by software to identify the presence of this peripheral.

Register 13: SSI Peripheral Identification 7 (SSIPeriphID7), offset 0xFDC

The **SSIPeriphIDn** registers are hard-coded and the fields within the register determine the reset value.

SSI Peripheral Identification 7 (SSIPeriphID7)

SSI0 base: 0x4000.8000

Offset 0xFDC

Type RO, reset 0x0000.0000

	31	30	29	28	27	26	25	24	23	22	21	20	19	18	17	16
	reserved															
Type	RO	RO	RO	RO	RO	RO	RO	RO	RO	RO	RO	RO	RO	RO	RO	RO
Reset	0	0	0	0	0	0	0	0	0	0	0	0	0	0	0	0
	15	14	13	12	11	10	9	8	7	6	5	4	3	2	1	0
	reserved								PID7							
Type	RO	RO	RO	RO	RO	RO	RO	RO	RO	RO	RO	RO	RO	RO	RO	RO
Reset	0	0	0	0	0	0	0	0	0	0	0	0	0	0	0	0

Bit/Field	Name	Type	Reset	Description
31:8	reserved	RO	0x00	Software should not rely on the value of a reserved bit. To provide compatibility with future products, the value of a reserved bit should be preserved across a read-modify-write operation.
7:0	PID7	RO	0x00	SSI Peripheral ID Register[31:24] Can be used by software to identify the presence of this peripheral.

Register 14: SSI Peripheral Identification 0 (SSIPeriphID0), offset 0xFE0

The **SSIPeriphIDn** registers are hard-coded and the fields within the register determine the reset value.

SSI Peripheral Identification 0 (SSIPeriphID0)

SSI0 base: 0x4000.8000
 Offset 0xFE0
 Type RO, reset 0x0000.0022

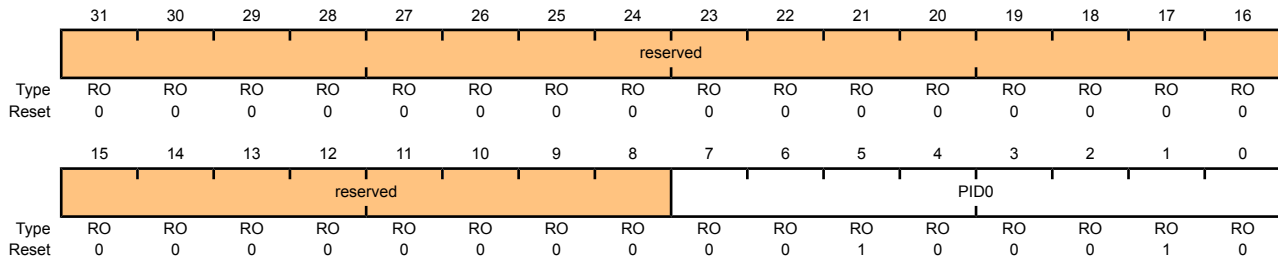

Bit/Field	Name	Type	Reset	Description
31:8	reserved	RO	0	Software should not rely on the value of a reserved bit. To provide compatibility with future products, the value of a reserved bit should be preserved across a read-modify-write operation.
7:0	PID0	RO	0x22	SSI Peripheral ID Register[7:0] Can be used by software to identify the presence of this peripheral.

Register 15: SSI Peripheral Identification 1 (SSIPeriphID1), offset 0xFE4

The **SSIPeriphIDn** registers are hard-coded and the fields within the register determine the reset value.

SSI Peripheral Identification 1 (SSIPeriphID1)

SSI0 base: 0x4000.8000

Offset 0xFE4

Type RO, reset 0x0000.0000

	31	30	29	28	27	26	25	24	23	22	21	20	19	18	17	16
	reserved															
Type	RO	RO	RO	RO	RO	RO	RO	RO	RO	RO	RO	RO	RO	RO	RO	RO
Reset	0	0	0	0	0	0	0	0	0	0	0	0	0	0	0	0
	15	14	13	12	11	10	9	8	7	6	5	4	3	2	1	0
	reserved								PID1							
Type	RO	RO	RO	RO	RO	RO	RO	RO	RO	RO	RO	RO	RO	RO	RO	RO
Reset	0	0	0	0	0	0	0	0	0	0	0	0	0	0	0	0

Bit/Field	Name	Type	Reset	Description
31:8	reserved	RO	0x00	Software should not rely on the value of a reserved bit. To provide compatibility with future products, the value of a reserved bit should be preserved across a read-modify-write operation.
7:0	PID1	RO	0x00	SSI Peripheral ID Register [15:8] Can be used by software to identify the presence of this peripheral.

Register 16: SSI Peripheral Identification 2 (SSIPeriphID2), offset 0xFE8

The **SSIPeriphIDn** registers are hard-coded and the fields within the register determine the reset value.

SSI Peripheral Identification 2 (SSIPeriphID2)

SSI0 base: 0x4000.8000
 Offset 0xFE8
 Type RO, reset 0x0000.0018

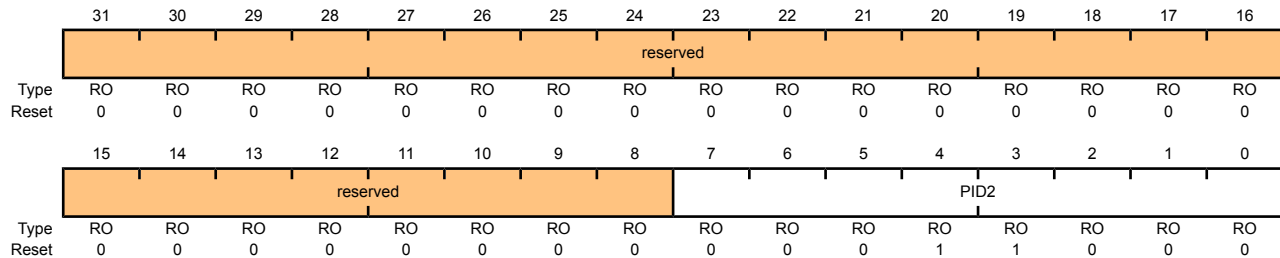

Bit/Field	Name	Type	Reset	Description
31:8	reserved	RO	0x00	Software should not rely on the value of a reserved bit. To provide compatibility with future products, the value of a reserved bit should be preserved across a read-modify-write operation.
7:0	PID2	RO	0x18	SSI Peripheral ID Register [23:16] Can be used by software to identify the presence of this peripheral.

Register 17: SSI Peripheral Identification 3 (SSIPeriphID3), offset 0xFEC

The **SSIPeriphIDn** registers are hard-coded and the fields within the register determine the reset value.

SSI Peripheral Identification 3 (SSIPeriphID3)

SSI0 base: 0x4000.8000

Offset 0xFEC

Type RO, reset 0x0000.0001

	31	30	29	28	27	26	25	24	23	22	21	20	19	18	17	16
	reserved															
Type	RO	RO	RO	RO	RO	RO	RO	RO	RO	RO	RO	RO	RO	RO	RO	RO
Reset	0	0	0	0	0	0	0	0	0	0	0	0	0	0	0	0
	15	14	13	12	11	10	9	8	7	6	5	4	3	2	1	0
	reserved								PID3							
Type	RO	RO	RO	RO	RO	RO	RO	RO	RO	RO	RO	RO	RO	RO	RO	RO
Reset	0	0	0	0	0	0	0	0	0	0	0	0	0	0	0	1

Bit/Field	Name	Type	Reset	Description
31:8	reserved	RO	0x00	Software should not rely on the value of a reserved bit. To provide compatibility with future products, the value of a reserved bit should be preserved across a read-modify-write operation.
7:0	PID3	RO	0x01	SSI Peripheral ID Register [31:24] Can be used by software to identify the presence of this peripheral.

Register 18: SSI PrimeCell Identification 0 (SSIPCellID0), offset 0xFF0

The **SSIPCellIDn** registers are hard-coded and the fields within the register determine the reset value.

SSI PrimeCell Identification 0 (SSIPCellID0)

SSI0 base: 0x4000.8000
 Offset 0xFF0
 Type RO, reset 0x0000.000D

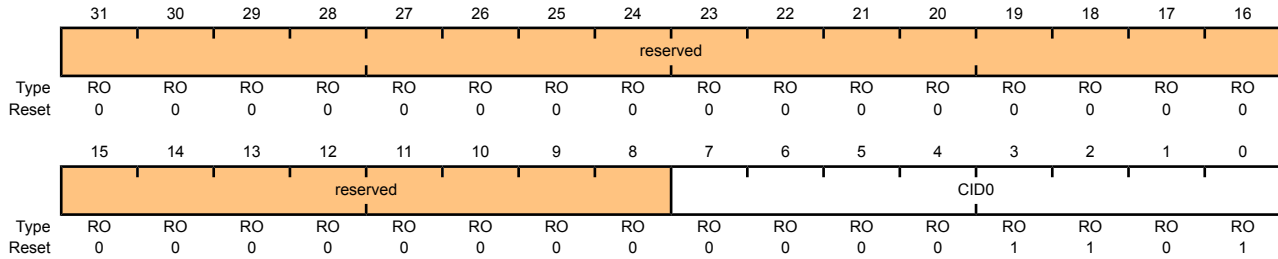

Bit/Field	Name	Type	Reset	Description
31:8	reserved	RO	0x00	Software should not rely on the value of a reserved bit. To provide compatibility with future products, the value of a reserved bit should be preserved across a read-modify-write operation.
7:0	CID0	RO	0x0D	SSI PrimeCell ID Register [7:0] Provides software a standard cross-peripheral identification system.

Register 19: SSI PrimeCell Identification 1 (SSIPCellID1), offset 0xFF4

The **SSIPCellIDn** registers are hard-coded and the fields within the register determine the reset value.

SSI PrimeCell Identification 1 (SSIPCellID1)

SSI0 base: 0x4000.8000

Offset 0xFF4

Type RO, reset 0x0000.00F0

	31	30	29	28	27	26	25	24	23	22	21	20	19	18	17	16
	reserved															
Type	RO	RO	RO	RO	RO	RO	RO	RO	RO	RO	RO	RO	RO	RO	RO	RO
Reset	0	0	0	0	0	0	0	0	0	0	0	0	0	0	0	0
	15	14	13	12	11	10	9	8	7	6	5	4	3	2	1	0
	reserved								CID1							
Type	RO	RO	RO	RO	RO	RO	RO	RO	RO	RO	RO	RO	RO	RO	RO	RO
Reset	0	0	0	0	0	0	0	0	1	1	1	1	0	0	0	0

Bit/Field	Name	Type	Reset	Description
31:8	reserved	RO	0x00	Software should not rely on the value of a reserved bit. To provide compatibility with future products, the value of a reserved bit should be preserved across a read-modify-write operation.
7:0	CID1	RO	0xF0	SSI PrimeCell ID Register [15:8] Provides software a standard cross-peripheral identification system.

Register 20: SSI PrimeCell Identification 2 (SSIPCellID2), offset 0xFF8

The **SSIPCellIDn** registers are hard-coded and the fields within the register determine the reset value.

SSI PrimeCell Identification 2 (SSIPCellID2)

SSI0 base: 0x4000.8000
 Offset 0xFF8
 Type RO, reset 0x0000.0005

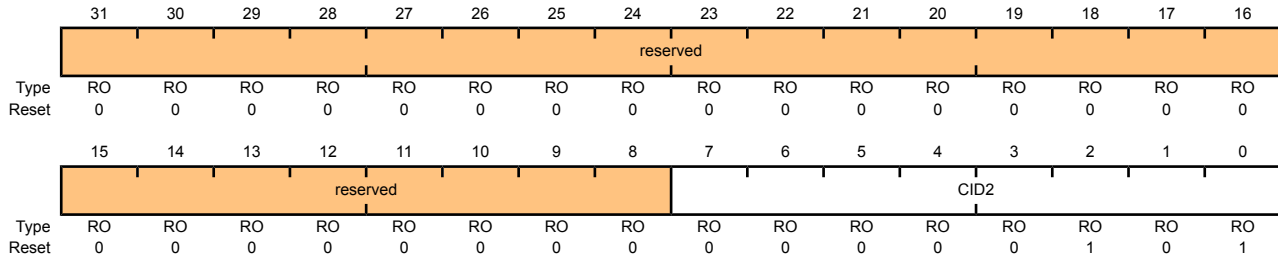

Bit/Field	Name	Type	Reset	Description
31:8	reserved	RO	0x00	Software should not rely on the value of a reserved bit. To provide compatibility with future products, the value of a reserved bit should be preserved across a read-modify-write operation.
7:0	CID2	RO	0x05	SSI PrimeCell ID Register [23:16] Provides software a standard cross-peripheral identification system.

Register 21: SSI PrimeCell Identification 3 (SSIPCellID3), offset 0xFFC

The **SSIPCellIDn** registers are hard-coded and the fields within the register determine the reset value.

SSI PrimeCell Identification 3 (SSIPCellID3)

SSI0 base: 0x4000.8000

Offset 0xFFC

Type RO, reset 0x0000.00B1

	31	30	29	28	27	26	25	24	23	22	21	20	19	18	17	16
	reserved															
Type	RO	RO	RO	RO	RO	RO	RO	RO	RO	RO	RO	RO	RO	RO	RO	RO
Reset	0	0	0	0	0	0	0	0	0	0	0	0	0	0	0	0
	15	14	13	12	11	10	9	8	7	6	5	4	3	2	1	0
	reserved								CID3							
Type	RO	RO	RO	RO	RO	RO	RO	RO	RO	RO	RO	RO	RO	RO	RO	RO
Reset	0	0	0	0	0	0	0	0	1	0	1	1	0	0	0	1

Bit/Field	Name	Type	Reset	Description
31:8	reserved	RO	0x00	Software should not rely on the value of a reserved bit. To provide compatibility with future products, the value of a reserved bit should be preserved across a read-modify-write operation.
7:0	CID3	RO	0xB1	SSI PrimeCell ID Register [31:24] Provides software a standard cross-peripheral identification system.

15 Inter-Integrated Circuit (I²C) Interface

The Inter-Integrated Circuit (I²C) bus provides bi-directional data transfer through a two-wire design (a serial data line SDA and a serial clock line SCL), and interfaces to external I²C devices such as serial memory (RAMs and ROMs), networking devices, LCDs, tone generators, and so on. The I²C bus may also be used for system testing and diagnostic purposes in product development and manufacture. The LM3S6916 microcontroller includes one I²C module, providing the ability to interact (both send and receive) with other I²C devices on the bus.

Devices on the I²C bus can be designated as either a master or a slave. The Stellaris[®] I²C module supports both sending and receiving data as either a master or a slave, and also supports the simultaneous operation as both a master and a slave. There are a total of four I²C modes: Master Transmit, Master Receive, Slave Transmit, and Slave Receive. The Stellaris[®] I²C module can operate at two speeds: Standard (100 Kbps) and Fast (400 Kbps).

Both the I²C master and slave can generate interrupts; the I²C master generates interrupts when a transmit or receive operation completes (or aborts due to an error) and the I²C slave generates interrupts when data has been sent or requested by a master.

15.1 Block Diagram

Figure 15-1. I²C Block Diagram

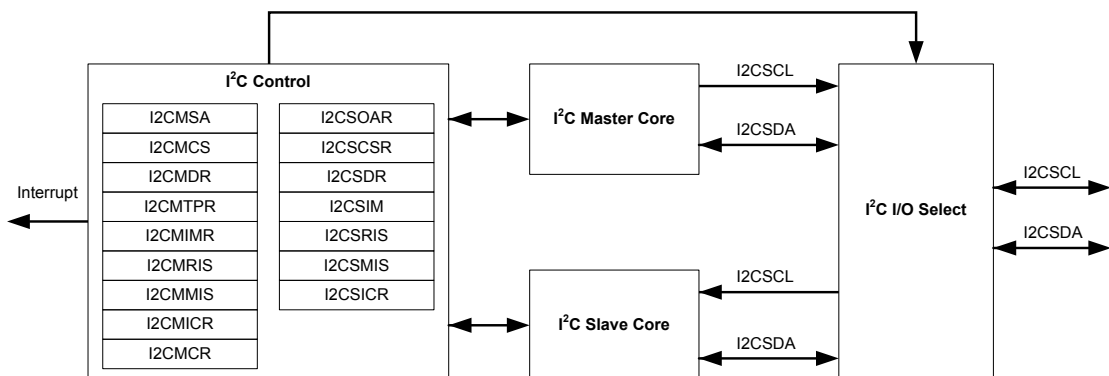

15.2 Functional Description

The I²C module is comprised of both master and slave functions which are implemented as separate peripherals. For proper operation, the SDA and SCL pins must be connected to bi-directional open-drain pads. A typical I²C bus configuration is shown in Figure 15-2 on page 367.

See "I²C" on page 500 for I²C timing diagrams.

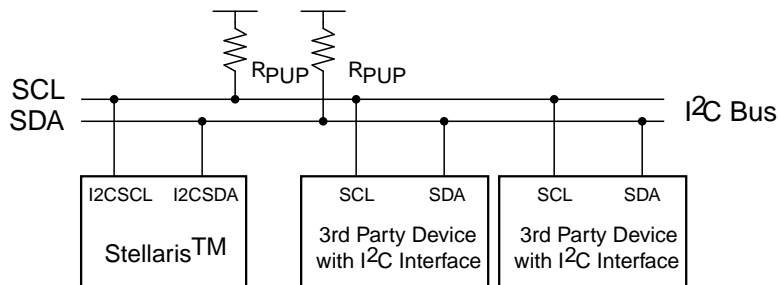
Figure 15-2. I²C Bus Configuration

15.2.1 I²C Bus Functional Overview

The I²C bus uses only two signals: SDA and SCL, named I2CSDA and I2CSCL on Stellaris[®] microcontrollers. SDA is the bi-directional serial data line and SCL is the bi-directional serial clock line. The bus is considered idle when both lines are high.

Every transaction on the I²C bus is nine bits long, consisting of eight data bits and a single acknowledge bit. The number of bytes per transfer (defined as the time between a valid START and STOP condition, described in “START and STOP Conditions” on page 367) is unrestricted, but each byte has to be followed by an acknowledge bit, and data must be transferred MSB first. When a receiver cannot receive another complete byte, it can hold the clock line SCL Low and force the transmitter into a wait state. The data transfer continues when the receiver releases the clock SCL.

15.2.1.1 START and STOP Conditions

The protocol of the I²C bus defines two states to begin and end a transaction: START and STOP. A high-to-low transition on the SDA line while the SCL is high is defined as a START condition, and a low-to-high transition on the SDA line while SCL is high is defined as a STOP condition. The bus is considered busy after a START condition and free after a STOP condition. See Figure 15-3 on page 367.

Figure 15-3. START and STOP Conditions

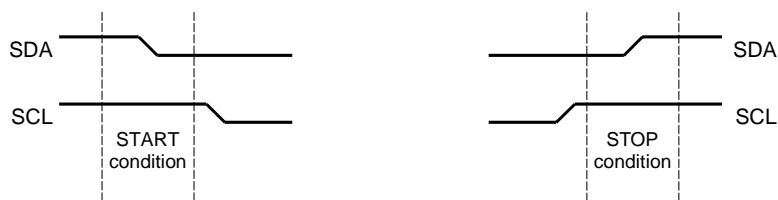

15.2.1.2 Data Format with 7-Bit Address

Data transfers follow the format shown in Figure 15-4 on page 368. After the START condition, a slave address is sent. This address is 7-bits long followed by an eighth bit, which is a data direction bit (R/S bit in the I2CMSA register). A zero indicates a transmit operation (send), and a one indicates a request for data (receive). A data transfer is always terminated by a STOP condition generated by the master, however, a master can initiate communications with another device on the bus by generating a repeated START condition and addressing another slave without first generating a STOP condition. Various combinations of receive/send formats are then possible within a single transfer.

Figure 15-4. Complete Data Transfer with a 7-Bit Address

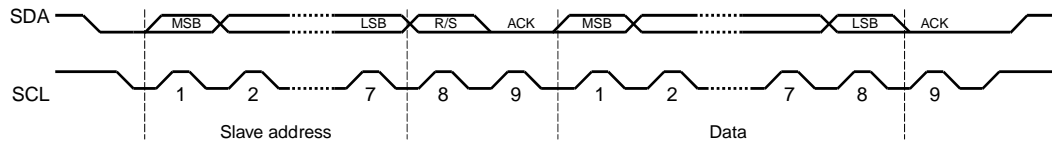

The first seven bits of the first byte make up the slave address (see Figure 15-5 on page 368). The eighth bit determines the direction of the message. A zero in the R/S position of the first byte means that the master will write (send) data to the selected slave, and a one in this position means that the master will receive data from the slave.

Figure 15-5. R/S Bit in First Byte

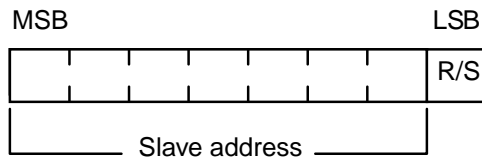

15.2.1.3 Data Validity

The data on the SDA line must be stable during the high period of the clock, and the data line can only change when SCL is low (see Figure 15-6 on page 368).

Figure 15-6. Data Validity During Bit Transfer on the I²C Bus

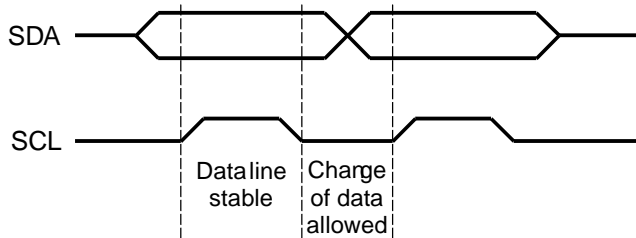

15.2.1.4 Acknowledge

All bus transactions have a required acknowledge clock cycle that is generated by the master. During the acknowledge cycle, the transmitter (which can be the master or slave) releases the SDA line. To acknowledge the transaction, the receiver must pull down SDA during the acknowledge clock cycle. The data sent out by the receiver during the acknowledge cycle must comply with the data validity requirements described in "Data Validity" on page 368.

When a slave receiver does not acknowledge the slave address, SDA must be left high by the slave so that the master can generate a STOP condition and abort the current transfer. If the master device is acting as a receiver during a transfer, it is responsible for acknowledging each transfer made by the slave. Since the master controls the number of bytes in the transfer, it signals the end of data to the slave transmitter by not generating an acknowledge on the last data byte. The slave transmitter must then release SDA to allow the master to generate the STOP or a repeated START condition.

15.2.1.5 Arbitration

A master may start a transfer only if the bus is idle. It's possible for two or more masters to generate a START condition within minimum hold time of the START condition. In these situations, an arbitration scheme takes place on the SDA line, while SCL is high. During arbitration, the first of the competing master devices to place a '1' (high) on SDA while another master transmits a '0' (low) will switch off its data output stage and retire until the bus is idle again.

Arbitration can take place over several bits. Its first stage is a comparison of address bits, and if both masters are trying to address the same device, arbitration continues on to the comparison of data bits.

15.2.2 Available Speed Modes

The I²C clock rate is determined by the parameters: CLK_PRD, TIMER_PRD, SCL_LP, and SCL_HP. where:

CLK_PRD is the system clock period

SCL_LP is the low phase of SCL (fixed at 6)

SCL_HP is the high phase of SCL (fixed at 4)

TIMER_PRD is the programmed value in the **I²C Master Timer Period (I2CMTPR)** register (see page 386).

The I²C clock period is calculated as follows:

$$SCL_PERIOD = 2 * (1 + TIMER_PRD) * (SCL_LP + SCL_HP) * CLK_PRD$$

For example:

CLK_PRD = 50 ns

TIMER_PRD = 2

SCL_LP=6

SCL_HP=4

yields a SCL frequency of:

$$1/T = 333 \text{ Khz}$$

Table 15-1 on page 369 gives examples of timer period, system clock, and speed mode (Standard or Fast).

Table 15-1. Examples of I²C Master Timer Period versus Speed Mode

System Clock	Timer Period	Standard Mode	Timer Period	Fast Mode
4 Mhz	0x01	100 Kbps	-	-
6 Mhz	0x02	100 Kbps	-	-
12.5 Mhz	0x06	89 Kbps	0x01	312 Kbps
16.7 Mhz	0x08	93 Kbps	0x02	278 Kbps
20 Mhz	0x09	100 Kbps	0x02	333 Kbps
25 Mhz	0x0C	96.2 Kbps	0x03	312 Kbps
33Mhz	0x10	97.1 Kbps	0x04	330 Kbps
40Mhz	0x13	100 Kbps	0x04	400 Kbps

System Clock	Timer Period	Standard Mode	Timer Period	Fast Mode
50Mhz	0x18	100 Kbps	0x06	357 Kbps

15.2.3 Interrupts

The I²C can generate interrupts when the following conditions are observed:

- Master transaction completed
- Master transaction error
- Slave transaction received
- Slave transaction requested

There is a separate interrupt signal for the I²C master and I²C modules. While both modules can generate interrupts for multiple conditions, only a single interrupt signal is sent to the interrupt controller.

15.2.3.1 I²C Master Interrupts

The I²C master module generates an interrupt when a transaction completes (either transmit or receive), or when an error occurs during a transaction. To enable the I²C master interrupt, software must write a '1' to the **I²C Master Interrupt Mask (I2CMIMR)** register. When an interrupt condition is met, software must check the `ERROR` bit in the **I²C Master Control/Status (I2CMCS)** register to verify that an error didn't occur during the last transaction. An error condition is asserted if the last transaction wasn't acknowledge by the slave or if the master was forced to give up ownership of the bus due to a lost arbitration round with another master. If an error is not detected, the application can proceed with the transfer. The interrupt is cleared by writing a '1' to the **I²C Master Interrupt Clear (I2CMICR)** register.

If the application doesn't require the use of interrupts, the raw interrupt status is always visible via the **I²C Master Raw Interrupt Status (I2CMRIS)** register.

15.2.3.2 I²C Slave Interrupts

The slave module generates interrupts as it receives requests from an I²C master. To enable the I²C slave interrupt, write a '1' to the **I²C Slave Interrupt Mask (I2CSIMR)** register. Software determines whether the module should write (transmit) or read (receive) data from the **I²C Slave Data (I2CSDR)** register, by checking the `RREQ` and `TREQ` bits of the **I²C Slave Control/Status (I2CSCSR)** register. If the slave module is in receive mode and the first byte of a transfer is received, the `FBR` bit is set along with the `RREQ` bit. The interrupt is cleared by writing a '1' to the **I²C Slave Interrupt Clear (I2CSICR)** register.

If the application doesn't require the use of interrupts, the raw interrupt status is always visible via the **I²C Slave Raw Interrupt Status (I2CSRIS)** register.

15.2.4 Loopback Operation

The I²C modules can be placed into an internal loopback mode for diagnostic or debug work. This is accomplished by setting the `LPBK` bit in the **I²C Master Configuration (I2CMCR)** register. In loopback mode, the SDA and SCL signals from the master and slave modules are tied together.

15.2.5 Command Sequence Flow Charts

This section details the steps required to perform the various I²C transfer types in both master and slave mode.

15.2.5.1 I²C Master Command Sequences

The figures that follow show the command sequences available for the I²C master.

Figure 15-7. Master Single SEND

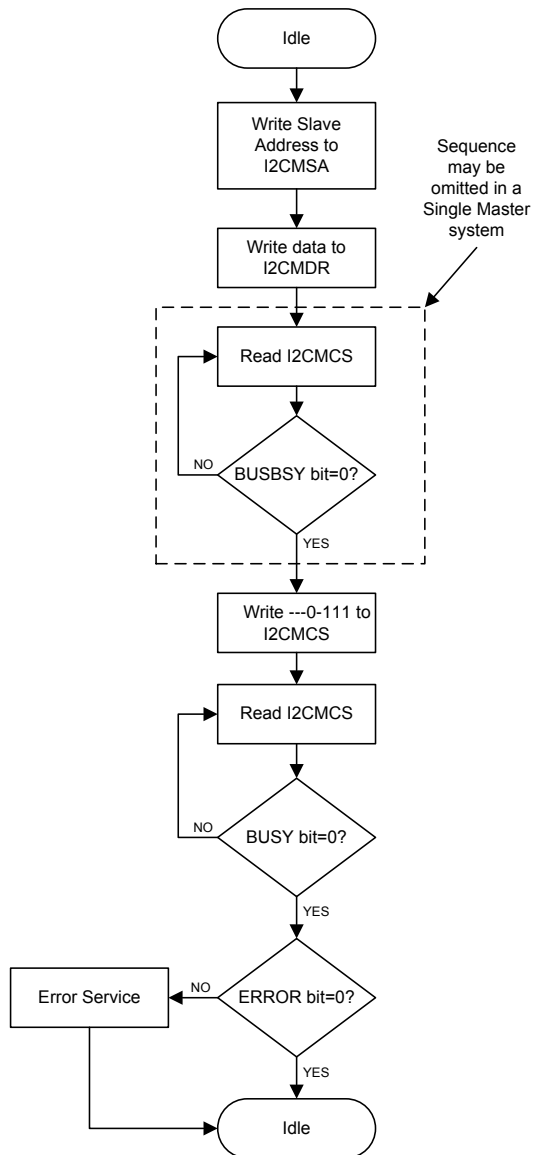

Figure 15-8. Master Single RECEIVE

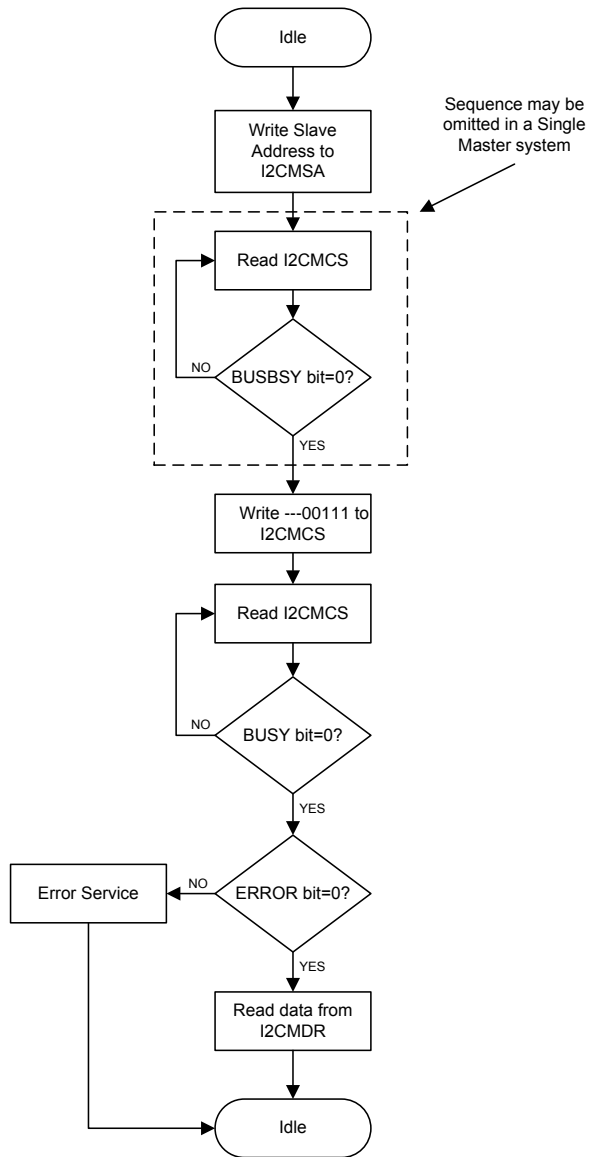

Figure 15-9. Master Burst SEND

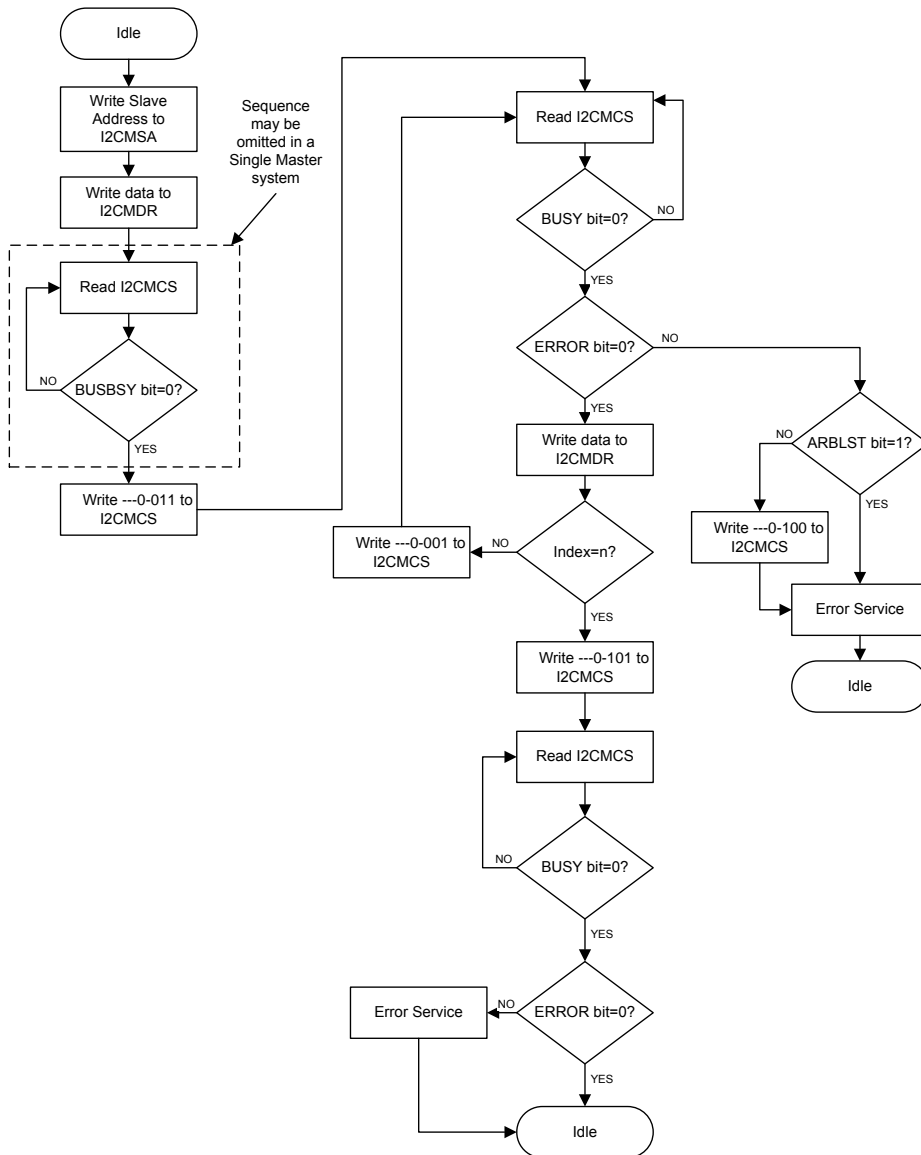

Figure 15-10. Master Burst RECEIVE

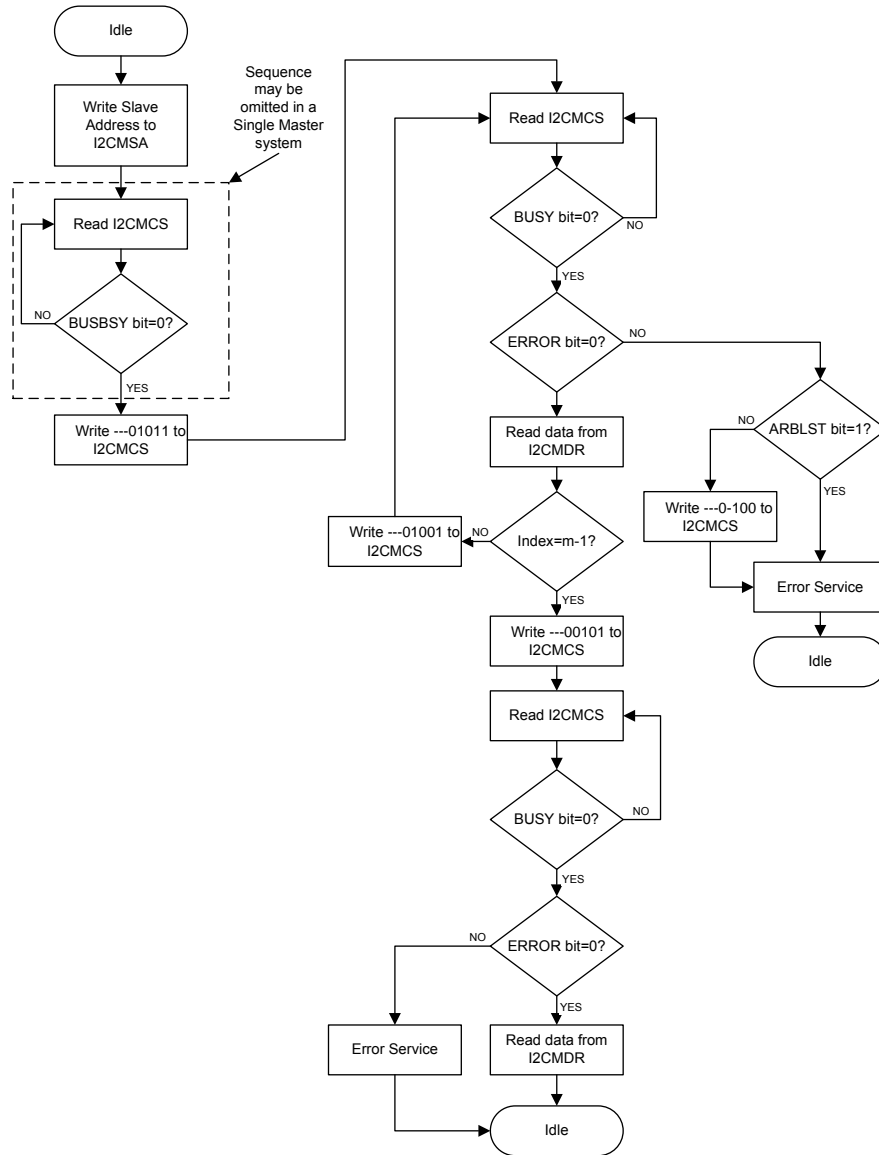

Figure 15-11. Master Burst RECEIVE after Burst SEND

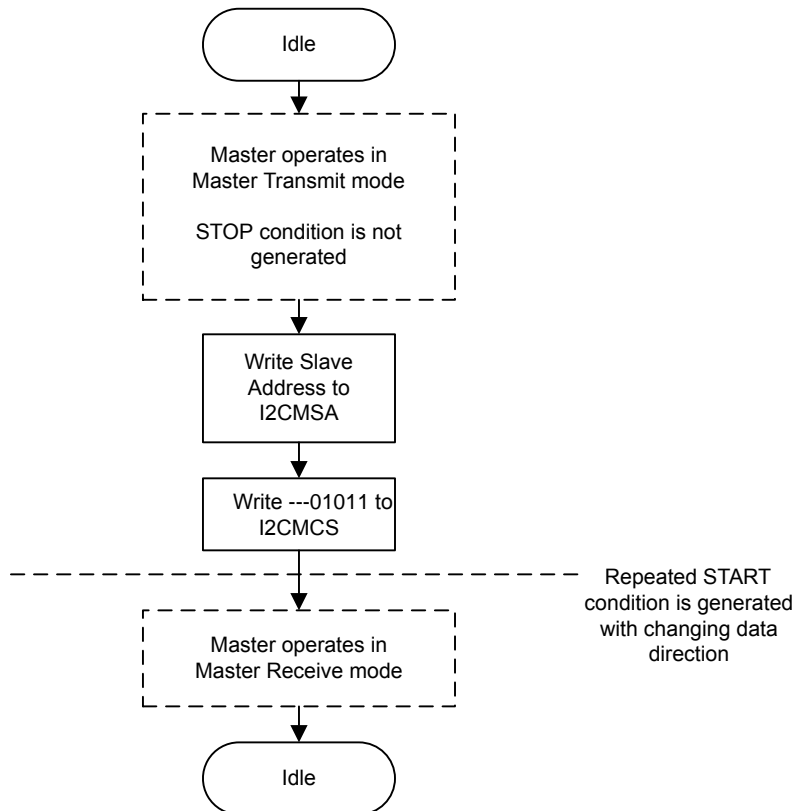
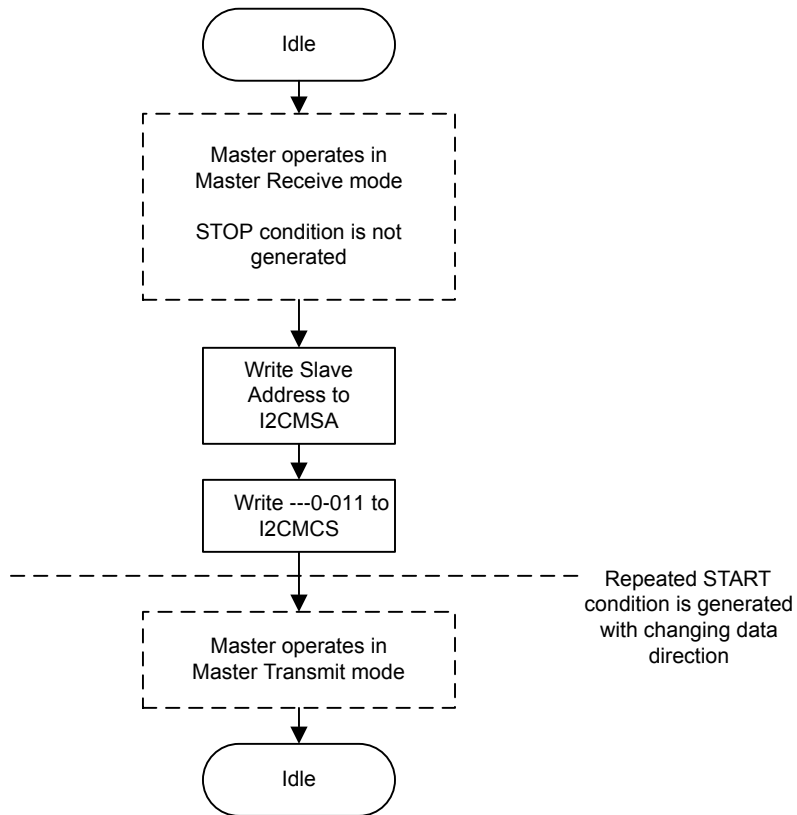

Figure 15-12. Master Burst SEND after Burst RECEIVE



15.2.5.2 I²C Slave Command Sequences

Figure 15-13 on page 377 presents the command sequence available for the I²C slave.

Figure 15-13. Slave Command Sequence

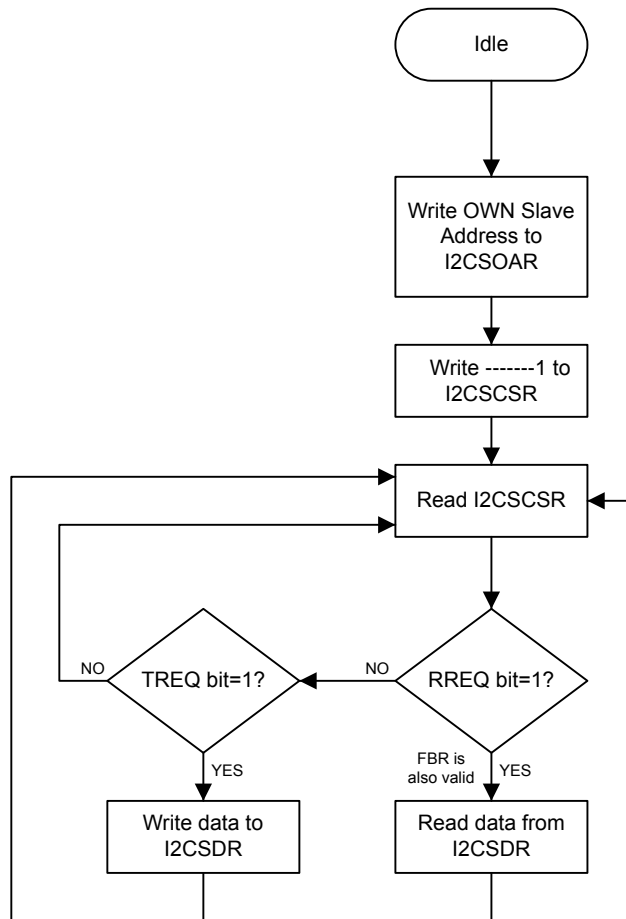

15.3 Initialization and Configuration

The following example shows how to configure the I²C module to send a single byte as a master. This assumes the system clock is 20 MHz.

1. Enable the I²C clock by writing a value of 0x0000.1000 to the **RCGC1** register in the System Control module.
2. Enable the clock to the appropriate GPIO module via the **RCGC2** register in the System Control module.
3. In the GPIO module, enable the appropriate pins for their alternate function using the **GPIOAFSEL** register. Also, be sure to enable the same pins for Open Drain operation.
4. Initialize the I²C Master by writing the **I2CMCR** register with a value of 0x0000.0020.
5. Set the desired SCL clock speed of 100 Kbps by writing the **I2CMTPR** register with the correct value. The value written to the **I2CMTPR** register represents the number of system clock periods in one SCL clock period. The TPR value is determined by the following equation:

```
TPR = (System Clock / (2 * (SCL_LP + SCL_HP) * SCL_CLK)) - 1;
TPR = (20MHz / (2 * (6 + 4) * 100000)) - 1;
TPR = 9
```

Write the **I2CMTPR** register with the value of 0x0000.0009.

6. Specify the slave address of the master and that the next operation will be a Send by writing the **I2CMSA** register with a value of 0x0000.0076. This sets the slave address to 0x3B.
7. Place data (byte) to be sent in the data register by writing the **I2CMDR** register with the desired data.
8. Initiate a single byte send of the data from Master to Slave by writing the **I2CMCS** register with a value of 0x0000.0007 (STOP, START, RUN).
9. Wait until the transmission completes by polling the **I2CMCS** register's **BUSBSY** bit until it has been cleared.

15.4 I²C Register Map

Table 15-2 on page 378 lists the I²C registers. All addresses given are relative to the I²C base addresses for the master and slave:

- I²C Master 0: 0x4002.0000
- I²C Slave 0: 0x4002.0800

Table 15-2. Inter-Integrated Circuit (I²C) Interface Register Map

Offset	Name	Type	Reset	Description	See page
I²C Master					
0x000	I2CMSA	R/W	0x0000.0000	I2C Master Slave Address	380
0x004	I2CMCS	R/W	0x0000.0000	I2C Master Control/Status	381
0x008	I2CMDR	R/W	0x0000.0000	I2C Master Data	385
0x00C	I2CMTPR	R/W	0x0000.0001	I2C Master Timer Period	386
0x010	I2CMIMR	R/W	0x0000.0000	I2C Master Interrupt Mask	387
0x014	I2CMRIS	RO	0x0000.0000	I2C Master Raw Interrupt Status	388
0x018	I2CMMIS	RO	0x0000.0000	I2C Master Masked Interrupt Status	389
0x01C	I2CMICR	WO	0x0000.0000	I2C Master Interrupt Clear	390
0x020	I2CMCR	R/W	0x0000.0000	I2C Master Configuration	391
I²C Slave					
0x000	I2CSOAR	R/W	0x0000.0000	I2C Slave Own Address	393
0x004	I2CSCSR	RO	0x0000.0000	I2C Slave Control/Status	394
0x008	I2CSDR	R/W	0x0000.0000	I2C Slave Data	396
0x00C	I2CSIMR	R/W	0x0000.0000	I2C Slave Interrupt Mask	397

Offset	Name	Type	Reset	Description	See page
0x010	I2CSRIS	RO	0x0000.0000	I2C Slave Raw Interrupt Status	398
0x014	I2CSMIS	RO	0x0000.0000	I2C Slave Masked Interrupt Status	399
0x018	I2CSICR	WO	0x0000.0000	I2C Slave Interrupt Clear	400

15.5 Register Descriptions (I²C Master)

The remainder of this section lists and describes the I²C master registers, in numerical order by address offset. See also “Register Descriptions (I2C Slave)” on page 392.

Register 1: I²C Master Slave Address (I2CMSA), offset 0x000

This register consists of eight bits: seven address bits (A6-A0), and a Receive/Send bit, which determines if the next operation is a Receive (High), or Send (Low).

I2C Master Slave Address (I2CMSA)

I2C Master 0 base: 0x4002.0000

Offset 0x000

Type R/W, reset 0x0000.0000

	31	30	29	28	27	26	25	24	23	22	21	20	19	18	17	16
	reserved															
Type	RO	RO	RO	RO	RO	RO	RO	RO	RO	RO	RO	RO	RO	RO	RO	RO
Reset	0	0	0	0	0	0	0	0	0	0	0	0	0	0	0	0
	15	14	13	12	11	10	9	8	7	6	5	4	3	2	1	0
	reserved								SA							R/S
Type	RO	RO	RO	RO	RO	RO	RO	RO	R/W	R/W	R/W	R/W	R/W	R/W	R/W	R/W
Reset	0	0	0	0	0	0	0	0	0	0	0	0	0	0	0	0

Bit/Field	Name	Type	Reset	Description
31:8	reserved	RO	0x00	Software should not rely on the value of a reserved bit. To provide compatibility with future products, the value of a reserved bit should be preserved across a read-modify-write operation.
7:1	SA	R/W	0	I ² C Slave Address This field specifies bits A6 through A0 of the slave address.
0	R/S	R/W	0	Receive/Send The R/S bit specifies if the next operation is a Receive (High) or Send (Low). Value Description 0 Send. 1 Receive.

Register 2: I²C Master Control/Status (I2CMCS), offset 0x004

This register accesses four control bits when written, and accesses seven status bits when read.

The status register consists of seven bits, which when read determine the state of the I²C bus controller.

The control register consists of four bits: the RUN, START, STOP, and ACK bits. The START bit causes the generation of the START, or REPEATED START condition.

The STOP bit determines if the cycle stops at the end of the data cycle, or continues on to a burst. To generate a single send cycle, the **I²C Master Slave Address (I2CMSA)** register is written with the desired address, the R/S bit is set to 0, and the Control register is written with ACK=X (0 or 1), STOP=1, START=1, and RUN=1 to perform the operation and stop. When the operation is completed (or aborted due an error), the interrupt pin becomes active and the data may be read from the **I2CMDR** register. When the I²C module operates in Master receiver mode, the ACK bit must be set normally to logic 1. This causes the I²C bus controller to send an acknowledge automatically after each byte. This bit must be reset when the I²C bus controller requires no further data to be sent from the slave transmitter.

Read-Only Status Register

I2C Master Control/Status (I2CMCS)

I2C Master 0 base: 0x4002.0000

Offset 0x004

Type RO, reset 0x0000.0000

	31	30	29	28	27	26	25	24	23	22	21	20	19	18	17	16	
	reserved																
Type	RO	RO	RO	RO	RO	RO	RO	RO	RO	RO	RO	RO	RO	RO	RO	RO	
Reset	0	0	0	0	0	0	0	0	0	0	0	0	0	0	0	0	
	15	14	13	12	11	10	9	8	7	6	5	4	3	2	1	0	
	reserved										BUSBSY	IDLE	ARBLST	DATAACK	ADRACK	ERROR	BUSY
Type	RO	RO	RO	RO	RO	RO	RO	RO	RO	RO	RO	RO	RO	RO	RO	RO	
Reset	0	0	0	0	0	0	0	0	0	0	0	0	0	0	0	0	

Bit/Field	Name	Type	Reset	Description
31:7	reserved	RO	0x00	Software should not rely on the value of a reserved bit. To provide compatibility with future products, the value of a reserved bit should be preserved across a read-modify-write operation.
6	BUSBSY	RO	0	Bus Busy This bit specifies the state of the I ² C bus. If set, the bus is busy; otherwise, the bus is idle. The bit changes based on the START and STOP conditions.
5	IDLE	RO	0	I ² C Idle This bit specifies the I ² C controller state. If set, the controller is idle; otherwise the controller is not idle.
4	ARBLST	RO	0	Arbitration Lost This bit specifies the result of bus arbitration. If set, the controller lost arbitration; otherwise, the controller won arbitration.

Bit/Field	Name	Type	Reset	Description
3	DATAACK	RO	0	Acknowledge Data This bit specifies the result of the last data operation. If set, the transmitted data was not acknowledged; otherwise, the data was acknowledged.
2	ADRACK	RO	0	Acknowledge Address This bit specifies the result of the last address operation. If set, the transmitted address was not acknowledged; otherwise, the address was acknowledged.
1	ERROR	RO	0	Error This bit specifies the result of the last bus operation. If set, an error occurred on the last operation; otherwise, no error was detected. The error can be from the slave address not being acknowledged, the transmit data not being acknowledged, or because the controller lost arbitration.
0	BUSY	RO	0	I ² C Busy This bit specifies the state of the controller. If set, the controller is busy; otherwise, the controller is idle. When the <code>BUSY</code> bit is set, the other status bits are not valid.

Write-Only Control Register

I²C Master Control/Status (I2CMCS)

I2C Master 0 base: 0x4002.0000
 Offset 0x004
 Type WO, reset 0x0000.0000

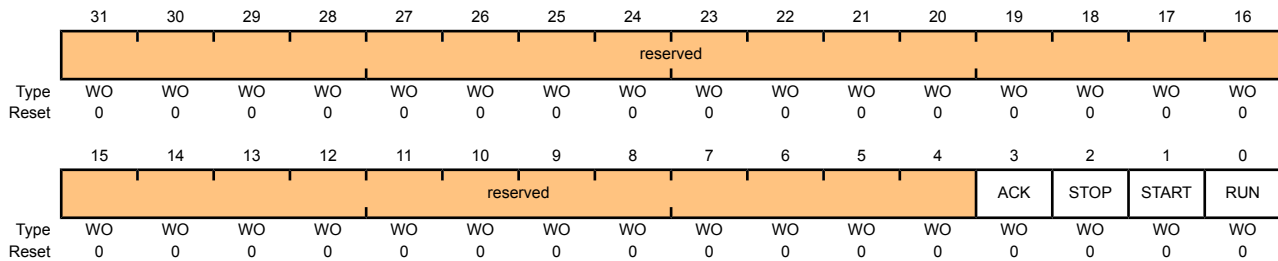

Bit/Field	Name	Type	Reset	Description
31:4	reserved	WO	0x00	Software should not rely on the value of a reserved bit. To provide compatibility with future products, the value of a reserved bit should be preserved across a read-modify-write operation.
3	ACK	WO	0	Data Acknowledge Enable When set, causes received data byte to be acknowledged automatically by the master. See field decoding in Table 15-3 on page 383.
2	STOP	WO	0	Generate STOP When set, causes the generation of the STOP condition. See field decoding in Table 15-3 on page 383.

Bit/Field	Name	Type	Reset	Description
1	START	WO	0	Generate START When set, causes the generation of a START or repeated START condition. See field decoding in Table 15-3 on page 383.
0	RUN	WO	0	I ² C Master Enable When set, allows the master to send or receive data. See field decoding in Table 15-3 on page 383.

Table 15-3. Write Field Decoding for I2CMCS[3:0] Field (Sheet 1 of 3)

Current State	I2CMSA[0]	I2CMCS[3:0]				Description
	R/S	ACK	STOP	START	RUN	
Idle	0	X ^a	0	1	1	START condition followed by SEND (master goes to the Master Transmit state).
	0	X	1	1	1	START condition followed by a SEND and STOP condition (master remains in Idle state).
	1	0	0	1	1	START condition followed by RECEIVE operation with negative ACK (master goes to the Master Receive state).
	1	0	1	1	1	START condition followed by RECEIVE and STOP condition (master remains in Idle state).
	1	1	0	1	1	START condition followed by RECEIVE (master goes to the Master Receive state).
	1	1	1	1	1	Illegal.
	All other combinations not listed are non-operations.					
Master Transmit	X	X	0	0	1	SEND operation (master remains in Master Transmit state).
	X	X	1	0	0	STOP condition (master goes to Idle state).
	X	X	1	0	1	SEND followed by STOP condition (master goes to Idle state).
	0	X	0	1	1	Repeated START condition followed by a SEND (master remains in Master Transmit state).
	0	X	1	1	1	Repeated START condition followed by SEND and STOP condition (master goes to Idle state).
	1	0	0	1	1	Repeated START condition followed by a RECEIVE operation with a negative ACK (master goes to Master Receive state).
	1	0	1	1	1	Repeated START condition followed by a SEND and STOP condition (master goes to Idle state).
	1	1	0	1	1	Repeated START condition followed by RECEIVE (master goes to Master Receive state).
	1	1	1	1	1	Illegal.
	All other combinations not listed are non-operations.					

Current State	I2CMSA[0]	I2CMCS[3:0]				Description
	R/S	ACK	STOP	START	RUN	
Master Receive	X	0	0	0	1	RECEIVE operation with negative ACK (master remains in Master Receive state).
	X	X	1	0	0	STOP condition (master goes to Idle state). ^b
	X	0	1	0	1	RECEIVE followed by STOP condition (master goes to Idle state).
	X	1	0	0	1	RECEIVE operation (master remains in Master Receive state).
	X	1	1	0	1	Illegal.
	1	0	0	1	1	Repeated START condition followed by RECEIVE operation with a negative ACK (master remains in Master Receive state).
	1	0	1	1	1	Repeated START condition followed by RECEIVE and STOP condition (master goes to Idle state).
	1	1	0	1	1	Repeated START condition followed by RECEIVE (master remains in Master Receive state).
	0	X	0	1	1	Repeated START condition followed by SEND (master goes to Master Transmit state).
	0	X	1	1	1	Repeated START condition followed by SEND and STOP condition (master goes to Idle state).
All other combinations not listed are non-operations.						NOP.

a. An X in a table cell indicates the bit can be 0 or 1.

b. In Master Receive mode, a STOP condition should be generated only after a Data Negative Acknowledge executed by the master or an Address Negative Acknowledge executed by the slave.

Register 3: I²C Master Data (I2CMDR), offset 0x008

This register contains the data to be transmitted when in the Master Transmit state, and the data received when in the Master Receive state.

I2C Master Data (I2CMDR)

I2C Master 0 base: 0x4002.0000

Offset 0x008

Type R/W, reset 0x0000.0000

	31	30	29	28	27	26	25	24	23	22	21	20	19	18	17	16
	reserved															
Type	RO	RO	RO	RO	RO	RO	RO	RO	RO	RO	RO	RO	RO	RO	RO	RO
Reset	0	0	0	0	0	0	0	0	0	0	0	0	0	0	0	0
	15	14	13	12	11	10	9	8	7	6	5	4	3	2	1	0
	reserved								DATA							
Type	RO	RO	RO	RO	RO	RO	RO	RO	R/W	R/W	R/W	R/W	R/W	R/W	R/W	R/W
Reset	0	0	0	0	0	0	0	0	0	0	0	0	0	0	0	0

Bit/Field	Name	Type	Reset	Description
31:8	reserved	RO	0x00	Software should not rely on the value of a reserved bit. To provide compatibility with future products, the value of a reserved bit should be preserved across a read-modify-write operation.
7:0	DATA	R/W	0x00	Data Transferred Data transferred during transaction.

Register 4: I²C Master Timer Period (I2CMTPR), offset 0x00C

This register specifies the period of the SCL clock.

I2C Master Timer Period (I2CMTPR)

I2C Master 0 base: 0x4002.0000

Offset 0x00C

Type R/W, reset 0x0000.0001

	31	30	29	28	27	26	25	24	23	22	21	20	19	18	17	16
	reserved															
Type	RO	RO	RO	RO	RO	RO	RO	RO	RO	RO	RO	RO	RO	RO	RO	RO
Reset	0	0	0	0	0	0	0	0	0	0	0	0	0	0	0	0
	15	14	13	12	11	10	9	8	7	6	5	4	3	2	1	0
	reserved								TPR							
Type	RO	RO	RO	RO	RO	RO	RO	RO	R/W	R/W	R/W	R/W	R/W	R/W	R/W	R/W
Reset	0	0	0	0	0	0	0	0	0	0	0	0	0	0	0	1

Bit/Field	Name	Type	Reset	Description
31:8	reserved	RO	0x00	Software should not rely on the value of a reserved bit. To provide compatibility with future products, the value of a reserved bit should be preserved across a read-modify-write operation.
7:0	TPR	R/W	0x1	SCL Clock Period

This field specifies the period of the SCL clock.

$$SCL_PRD = 2 * (1 + TPR) * (SCL_LP + SCL_HP) * CLK_PRD$$

where:

- SCL_PRD is the SCL line period (I²C clock).
- TPR is the Timer Period register value (range of 1 to 255).
- SCL_LP is the SCL Low period (fixed at 6).
- SCL_HP is the SCL High period (fixed at 4).

Register 5: I²C Master Interrupt Mask (I2CMIMR), offset 0x010

This register controls whether a raw interrupt is promoted to a controller interrupt.

I2C Master Interrupt Mask (I2CMIMR)

I2C Master 0 base: 0x4002.0000

Offset 0x010

Type R/W, reset 0x0000.0000

	31	30	29	28	27	26	25	24	23	22	21	20	19	18	17	16
	reserved															
Type	RO	RO	RO	RO	RO	RO	RO	RO	RO	RO	RO	RO	RO	RO	RO	RO
Reset	0	0	0	0	0	0	0	0	0	0	0	0	0	0	0	0
	15	14	13	12	11	10	9	8	7	6	5	4	3	2	1	0
	reserved															IM
Type	RO	RO	RO	RO	RO	RO	RO	RO	RO	RO	RO	RO	RO	RO	RO	R/W
Reset	0	0	0	0	0	0	0	0	0	0	0	0	0	0	0	0

Bit/Field	Name	Type	Reset	Description
31:1	reserved	RO	0x00	Software should not rely on the value of a reserved bit. To provide compatibility with future products, the value of a reserved bit should be preserved across a read-modify-write operation.
0	IM	R/W	0	Interrupt Mask This bit controls whether a raw interrupt is promoted to a controller interrupt. If set, the interrupt is not masked and the interrupt is promoted; otherwise, the interrupt is masked.

Register 6: I²C Master Raw Interrupt Status (I2CMRIS), offset 0x014

This register specifies whether an interrupt is pending.

I2C Master Raw Interrupt Status (I2CMRIS)

I2C Master 0 base: 0x4002.0000

Offset 0x014

Type RO, reset 0x0000.0000

	31	30	29	28	27	26	25	24	23	22	21	20	19	18	17	16
	reserved															
Type	RO	RO	RO	RO	RO	RO	RO	RO	RO	RO	RO	RO	RO	RO	RO	RO
Reset	0	0	0	0	0	0	0	0	0	0	0	0	0	0	0	0
	15	14	13	12	11	10	9	8	7	6	5	4	3	2	1	0
	reserved															RIS
Type	RO	RO	RO	RO	RO	RO	RO	RO	RO	RO	RO	RO	RO	RO	RO	RO
Reset	0	0	0	0	0	0	0	0	0	0	0	0	0	0	0	0

Bit/Field	Name	Type	Reset	Description
31:1	reserved	RO	0x00	Software should not rely on the value of a reserved bit. To provide compatibility with future products, the value of a reserved bit should be preserved across a read-modify-write operation.
0	RIS	RO	0	Raw Interrupt Status This bit specifies the raw interrupt state (prior to masking) of the I ² C master block. If set, an interrupt is pending; otherwise, an interrupt is not pending.

Register 7: I²C Master Masked Interrupt Status (I2CMMIS), offset 0x018

This register specifies whether an interrupt was signaled.

I2C Master Masked Interrupt Status (I2CMMIS)

I2C Master 0 base: 0x4002.0000

Offset 0x018

Type RO, reset 0x0000.0000

	31	30	29	28	27	26	25	24	23	22	21	20	19	18	17	16
	reserved															
Type	RO	RO	RO	RO	RO	RO	RO	RO	RO	RO	RO	RO	RO	RO	RO	RO
Reset	0	0	0	0	0	0	0	0	0	0	0	0	0	0	0	0
	15	14	13	12	11	10	9	8	7	6	5	4	3	2	1	0
	reserved															MIS
Type	RO	RO	RO	RO	RO	RO	RO	RO	RO	RO	RO	RO	RO	RO	RO	RO
Reset	0	0	0	0	0	0	0	0	0	0	0	0	0	0	0	0

Bit/Field	Name	Type	Reset	Description
31:1	reserved	RO	0x00	Software should not rely on the value of a reserved bit. To provide compatibility with future products, the value of a reserved bit should be preserved across a read-modify-write operation.
0	MIS	RO	0	Masked Interrupt Status This bit specifies the raw interrupt state (after masking) of the I ² C master block. If set, an interrupt was signaled; otherwise, an interrupt has not been generated since the bit was last cleared.

Register 8: I²C Master Interrupt Clear (I2CMICR), offset 0x01C

This register clears the raw interrupt.

I2C Master Interrupt Clear (I2CMICR)

I2C Master 0 base: 0x4002.0000

Offset 0x01C

Type WO, reset 0x0000.0000

	31	30	29	28	27	26	25	24	23	22	21	20	19	18	17	16	
	reserved																
Type	RO	RO	RO	RO	RO	RO	RO	RO	RO	RO	RO	RO	RO	RO	RO	RO	
Reset	0	0	0	0	0	0	0	0	0	0	0	0	0	0	0	0	
	15	14	13	12	11	10	9	8	7	6	5	4	3	2	1	0	
	reserved															IC	
Type	RO	RO	RO	RO	RO	RO	RO	RO	RO	RO	RO	RO	RO	RO	RO	RO	WO
Reset	0	0	0	0	0	0	0	0	0	0	0	0	0	0	0	0	0

Bit/Field	Name	Type	Reset	Description
31:1	reserved	RO	0x00	Software should not rely on the value of a reserved bit. To provide compatibility with future products, the value of a reserved bit should be preserved across a read-modify-write operation.
0	IC	WO	0	<p>Interrupt Clear</p> <p>This bit controls the clearing of the raw interrupt. A write of 1 clears the interrupt; otherwise, a write of 0 has no affect on the interrupt state. A read of this register returns no meaningful data.</p>

Register 9: I²C Master Configuration (I2CMCR), offset 0x020

This register configures the mode (Master or Slave) and sets the interface for test mode loopback.

I2C Master Configuration (I2CMCR)

I2C Master 0 base: 0x4002.0000

Offset 0x020

Type R/W, reset 0x0000.0000

	31	30	29	28	27	26	25	24	23	22	21	20	19	18	17	16	
	reserved																
Type	RO	RO	RO	RO	RO	RO	RO	RO	RO	RO	RO	RO	RO	RO	RO	RO	
Reset	0	0	0	0	0	0	0	0	0	0	0	0	0	0	0	0	
	15	14	13	12	11	10	9	8	7	6	5	4	3	2	1	0	
	reserved											SFE	MFE	reserved		LPBK	
Type	RO	RO	RO	RO	RO	RO	RO	RO	RO	RO	RO	R/W	R/W	RO	RO	RO	R/W
Reset	0	0	0	0	0	0	0	0	0	0	0	0	0	0	0	0	0

Bit/Field	Name	Type	Reset	Description
31:6	reserved	RO	0x00	Software should not rely on the value of a reserved bit. To provide compatibility with future products, the value of a reserved bit should be preserved across a read-modify-write operation.
5	SFE	R/W	0	I ² C Slave Function Enable This bit specifies whether the interface may operate in Slave mode. If set, Slave mode is enabled; otherwise, Slave mode is disabled.
4	MFE	R/W	0	I ² C Master Function Enable This bit specifies whether the interface may operate in Master mode. If set, Master mode is enabled; otherwise, Master mode is disabled and the interface clock is disabled.
3:1	reserved	RO	0x00	Software should not rely on the value of a reserved bit. To provide compatibility with future products, the value of a reserved bit should be preserved across a read-modify-write operation.
0	LPBK	R/W	0	I ² C Loopback This bit specifies whether the interface is operating normally or in Loopback mode. If set, the device is put in a test mode loopback configuration; otherwise, the device operates normally.

15.6 Register Descriptions (I²C Slave)

The remainder of this section lists and describes the I²C slave registers, in numerical order by address offset. See also “Register Descriptions (I²C Master)” on page 379.

Register 10: I²C Slave Own Address (I2CSOAR), offset 0x000

This register consists of seven address bits that identify the Stellaris[®] I²C device on the I²C bus.

I2C Slave Own Address (I2CSOAR)

I2C Slave 0 base: 0x4002.0800

Offset 0x000

Type R/W, reset 0x0000.0000

	31	30	29	28	27	26	25	24	23	22	21	20	19	18	17	16
	reserved															
Type	RO	RO	RO	RO	RO	RO	RO	RO	RO	RO	RO	RO	RO	RO	RO	RO
Reset	0	0	0	0	0	0	0	0	0	0	0	0	0	0	0	0
	15	14	13	12	11	10	9	8	7	6	5	4	3	2	1	0
	reserved										OAR					
Type	RO	RO	RO	RO	RO	RO	RO	RO	RO	R/W	R/W	R/W	R/W	R/W	R/W	R/W
Reset	0	0	0	0	0	0	0	0	0	0	0	0	0	0	0	0

Bit/Field	Name	Type	Reset	Description
31:7	reserved	RO	0x00	Software should not rely on the value of a reserved bit. To provide compatibility with future products, the value of a reserved bit should be preserved across a read-modify-write operation.
6:0	OAR	R/W	0x00	I ² C Slave Own Address This field specifies bits A6 through A0 of the slave address.

Register 11: I²C Slave Control/Status (I2CCSR), offset 0x004

This register accesses one control bit when written, and three status bits when read.

The read-only Status register consists of three bits: the `FBR`, `RREQ`, and `TREQ` bits. The `First Byte Received (FBR)` bit is set only after the Stellaris[®] device detects its own slave address and receives the first data byte from the I²C master. The `Receive Request (RREQ)` bit indicates that the Stellaris[®] I²C device has received a data byte from an I²C master. Read one data byte from the **I²C Slave Data (I2CSDR)** register to clear the `RREQ` bit. The `Transmit Request (TREQ)` bit indicates that the Stellaris[®] I²C device is addressed as a Slave Transmitter. Write one data byte into the **I²C Slave Data (I2CSDR)** register to clear the `TREQ` bit.

The write-only Control register consists of one bit: the `DA` bit. The `DA` bit enables and disables the Stellaris[®] I²C slave operation.

Read-Only Status Register

I2C Slave Control/Status (I2CCSR)

I2C Slave 0 base: 0x4002.0800

Offset 0x004

Type RO, reset 0x0000.0000

	31	30	29	28	27	26	25	24	23	22	21	20	19	18	17	16
	reserved															
Type	RO	RO	RO	RO	RO	RO	RO	RO	RO	RO	RO	RO	RO	RO	RO	RO
Reset	0	0	0	0	0	0	0	0	0	0	0	0	0	0	0	0
	15	14	13	12	11	10	9	8	7	6	5	4	3	2	1	0
	reserved													FBR	TREQ	RREQ
Type	RO	RO	RO	RO	RO	RO	RO	RO	RO	RO	RO	RO	RO	RO	RO	RO
Reset	0	0	0	0	0	0	0	0	0	0	0	0	0	0	0	0

Bit/Field	Name	Type	Reset	Description
31:3	reserved	RO	0x00	Software should not rely on the value of a reserved bit. To provide compatibility with future products, the value of a reserved bit should be preserved across a read-modify-write operation.
2	FBR	RO	0	<p>First Byte Received</p> <p>Indicates that the first byte following the slave's own address is received. This bit is only valid when the <code>RREQ</code> bit is set, and is automatically cleared when data has been read from the I2CSDR register.</p> <p>Note: This bit is not used for slave transmit operations.</p>
1	TREQ	RO	0	<p>Transmit Request</p> <p>This bit specifies the state of the I²C slave with regards to outstanding transmit requests. If set, the I²C unit has been addressed as a slave transmitter and uses clock stretching to delay the master until data has been written to the I2CSDR register. Otherwise, there is no outstanding transmit request.</p>
0	RREQ	RO	0	<p>Receive Request</p> <p>This bit specifies the status of the I²C slave with regards to outstanding receive requests. If set, the I²C unit has outstanding receive data from the I²C master and uses clock stretching to delay the master until the data has been read from the I2CSDR register. Otherwise, no receive data is outstanding.</p>

Write-Only Control Register

I2C Slave Control/Status (I2CSCSR)

I2C Slave 0 base: 0x4002.0800

Offset 0x004

Type WO, reset 0x0000.0000

	31	30	29	28	27	26	25	24	23	22	21	20	19	18	17	16	
	reserved																
Type	RO	RO	RO	RO	RO	RO	RO	RO	RO	RO	RO	RO	RO	RO	RO	RO	
Reset	0	0	0	0	0	0	0	0	0	0	0	0	0	0	0	0	
	15	14	13	12	11	10	9	8	7	6	5	4	3	2	1	0	
	reserved															DA	
Type	RO	RO	RO	RO	RO	RO	RO	RO	RO	RO	RO	RO	RO	RO	RO	RO	WO
Reset	0	0	0	0	0	0	0	0	0	0	0	0	0	0	0	0	

Bit/Field	Name	Type	Reset	Description
31:1	reserved	RO	0x00	Software should not rely on the value of a reserved bit. To provide compatibility with future products, the value of a reserved bit should be preserved across a read-modify-write operation.
0	DA	WO	0	Device Active
				Value Description
				0 Disables the I ² C slave operation.
				1 Enables the I ² C slave operation.

Register 12: I²C Slave Data (I2CSDR), offset 0x008

This register contains the data to be transmitted when in the Slave Transmit state, and the data received when in the Slave Receive state.

I2C Slave Data (I2CSDR)

I2C Slave 0 base: 0x4002.0800

Offset 0x008

Type R/W, reset 0x0000.0000

	31	30	29	28	27	26	25	24	23	22	21	20	19	18	17	16
	reserved															
Type	RO	RO	RO	RO	RO	RO	RO	RO	RO	RO	RO	RO	RO	RO	RO	RO
Reset	0	0	0	0	0	0	0	0	0	0	0	0	0	0	0	0
	15	14	13	12	11	10	9	8	7	6	5	4	3	2	1	0
	reserved								DATA							
Type	RO	RO	RO	RO	RO	RO	RO	RO	R/W	R/W	R/W	R/W	R/W	R/W	R/W	R/W
Reset	0	0	0	0	0	0	0	0	0	0	0	0	0	0	0	0

Bit/Field	Name	Type	Reset	Description
31:8	reserved	RO	0x00	Software should not rely on the value of a reserved bit. To provide compatibility with future products, the value of a reserved bit should be preserved across a read-modify-write operation.
7:0	DATA	R/W	0x0	Data for Transfer This field contains the data for transfer during a slave receive or transmit operation.

Register 13: I²C Slave Interrupt Mask (I2CSIMR), offset 0x00C

This register controls whether a raw interrupt is promoted to a controller interrupt.

I2C Slave Interrupt Mask (I2CSIMR)

I2C Slave 0 base: 0x4002.0800

Offset 0x00C

Type R/W, reset 0x0000.0000

	31	30	29	28	27	26	25	24	23	22	21	20	19	18	17	16
	reserved															
Type	RO	RO	RO	RO	RO	RO	RO	RO	RO	RO	RO	RO	RO	RO	RO	RO
Reset	0	0	0	0	0	0	0	0	0	0	0	0	0	0	0	0
	15	14	13	12	11	10	9	8	7	6	5	4	3	2	1	0
	reserved															IM
Type	RO	RO	RO	RO	RO	RO	RO	RO	RO	RO	RO	RO	RO	RO	RO	R/W
Reset	0	0	0	0	0	0	0	0	0	0	0	0	0	0	0	0

Bit/Field	Name	Type	Reset	Description
31:1	reserved	RO	0x00	Software should not rely on the value of a reserved bit. To provide compatibility with future products, the value of a reserved bit should be preserved across a read-modify-write operation.
0	IM	R/W	0	Interrupt Mask This bit controls whether a raw interrupt is promoted to a controller interrupt. If set, the interrupt is not masked and the interrupt is promoted; otherwise, the interrupt is masked.

Register 14: I²C Slave Raw Interrupt Status (I2CSRIS), offset 0x010

This register specifies whether an interrupt is pending.

I2C Slave Raw Interrupt Status (I2CSRIS)

I2C Slave 0 base: 0x4002.0800

Offset 0x010

Type RO, reset 0x0000.0000

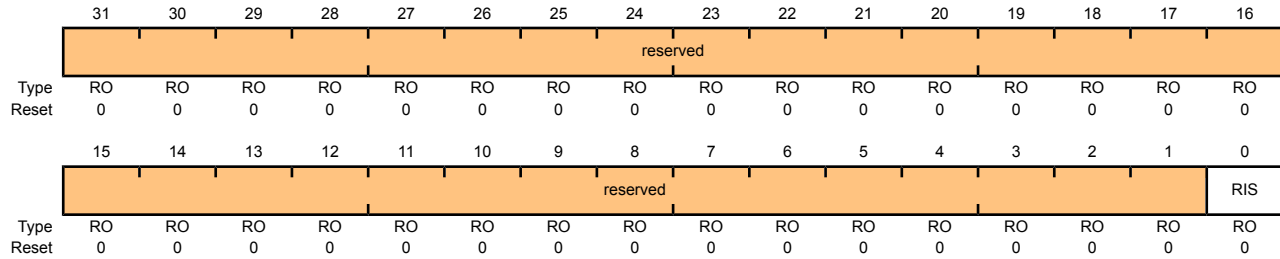

Bit/Field	Name	Type	Reset	Description
31:1	reserved	RO	0x00	Software should not rely on the value of a reserved bit. To provide compatibility with future products, the value of a reserved bit should be preserved across a read-modify-write operation.
0	RIS	RO	0	Raw Interrupt Status This bit specifies the raw interrupt state (prior to masking) of the I ² C slave block. If set, an interrupt is pending; otherwise, an interrupt is not pending.

Register 15: I²C Slave Masked Interrupt Status (I2CSMIS), offset 0x014

This register specifies whether an interrupt was signaled.

I2C Slave Masked Interrupt Status (I2CSMIS)

I2C Slave 0 base: 0x4002.0800

Offset 0x014

Type RO, reset 0x0000.0000

	31	30	29	28	27	26	25	24	23	22	21	20	19	18	17	16
	reserved															
Type	RO	RO	RO	RO	RO	RO	RO	RO	RO	RO	RO	RO	RO	RO	RO	RO
Reset	0	0	0	0	0	0	0	0	0	0	0	0	0	0	0	0
	15	14	13	12	11	10	9	8	7	6	5	4	3	2	1	0
	reserved															MIS
Type	RO	RO	RO	RO	RO	RO	RO	RO	RO	RO	RO	RO	RO	RO	RO	RO
Reset	0	0	0	0	0	0	0	0	0	0	0	0	0	0	0	0

Bit/Field	Name	Type	Reset	Description
31:1	reserved	RO	0x00	Software should not rely on the value of a reserved bit. To provide compatibility with future products, the value of a reserved bit should be preserved across a read-modify-write operation.
0	MIS	RO	0	Masked Interrupt Status This bit specifies the raw interrupt state (after masking) of the I ² C slave block. If set, an interrupt was signaled; otherwise, an interrupt has not been generated since the bit was last cleared.

Register 16: I²C Slave Interrupt Clear (I2CSICR), offset 0x018

This register clears the raw interrupt.

I2C Slave Interrupt Clear (I2CSICR)

I2C Slave 0 base: 0x4002.0800

Offset 0x018

Type WO, reset 0x0000.0000

	31	30	29	28	27	26	25	24	23	22	21	20	19	18	17	16	
	reserved																
Type	RO	RO	RO	RO	RO	RO	RO	RO	RO	RO	RO	RO	RO	RO	RO	RO	
Reset	0	0	0	0	0	0	0	0	0	0	0	0	0	0	0	0	
	15	14	13	12	11	10	9	8	7	6	5	4	3	2	1	0	
	reserved															IC	
Type	RO	RO	RO	RO	RO	RO	RO	RO	RO	RO	RO	RO	RO	RO	RO	RO	WO
Reset	0	0	0	0	0	0	0	0	0	0	0	0	0	0	0	0	0

Bit/Field	Name	Type	Reset	Description
31:1	reserved	RO	0x00	Software should not rely on the value of a reserved bit. To provide compatibility with future products, the value of a reserved bit should be preserved across a read-modify-write operation.
0	IC	WO	0	Clear Interrupt This bit controls the clearing of the raw interrupt. A write of 1 clears the interrupt; otherwise a write of 0 has no affect on the interrupt state. A read of this register returns no meaningful data.

16 Ethernet Controller

The Stellaris[®] Ethernet Controller consists of a fully integrated media access controller (MAC) and network physical (PHY) interface device. The Ethernet Controller conforms to *IEEE 802.3* specifications and fully supports 10BASE-T and 100BASE-TX standards.

The Ethernet Controller module has the following features:

- Conforms to the *IEEE 802.3-2002 specification*
 - 10BASE-T/100BASE-TX IEEE-802.3 compliant. Requires only a dual 1:1 isolation transformer interface to the line
 - 10BASE-T/100BASE-TX ENDEC, 100BASE-TX scrambler/descrambler
 - Full-featured auto-negotiation
- Multiple operational modes
 - Full- and half-duplex 100 Mbps
 - Full- and half-duplex 10 Mbps
 - Power-saving and power-down modes
- Highly configurable
 - Programmable MAC address
 - LED activity selection
 - Promiscuous mode support
 - CRC error-rejection control
 - User-configurable interrupts
- Physical media manipulation
 - Automatic MDI/MDI-X cross-over correction
 - Register-programmable transmit amplitude
 - Automatic polarity correction and 10BASE-T signal reception

16.1 Block Diagram

Figure 16-1. Ethernet Controller Block Diagram

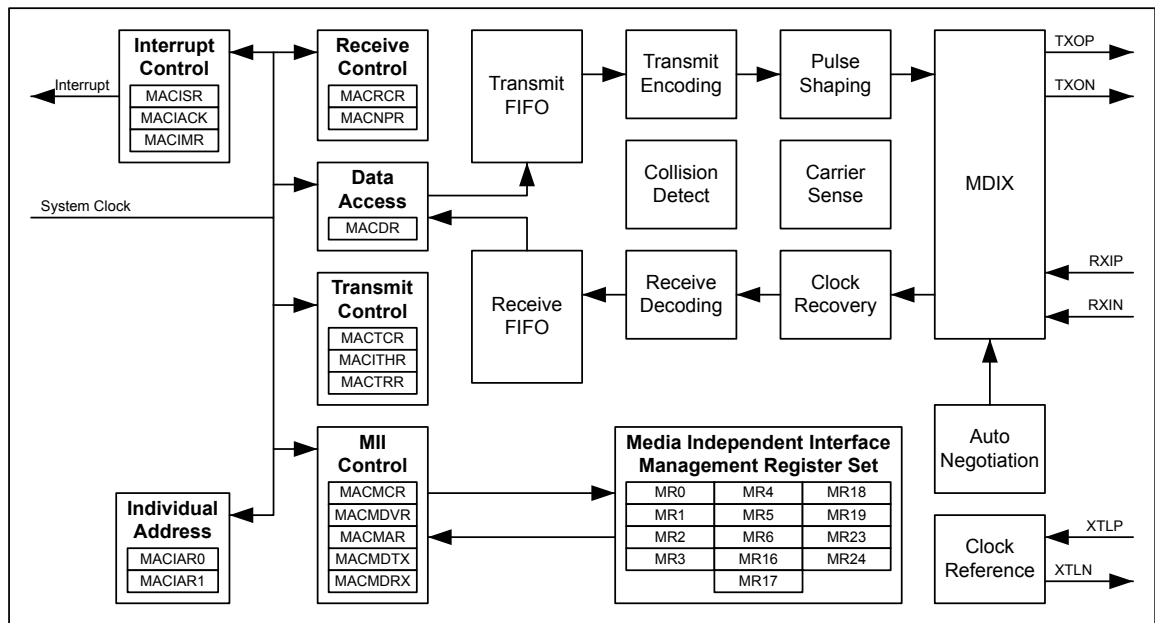

16.2 Functional Description

As shown in Figure 16-2 on page 402, the Ethernet Controller is functionally divided into two layers or modules: the Media Access Controller (MAC) layer and the Network Physical (PHY) layer. These correspond to the OSI model layers 2 and 1. The primary interface to the Ethernet Controller is a simple bus interface to the MAC layer. The MAC layer provides transmit and receive processing for Ethernet frames. The MAC layer also provides the interface to the PHY module via an internal Media Independent Interface (MII).

Figure 16-2. Ethernet Controller

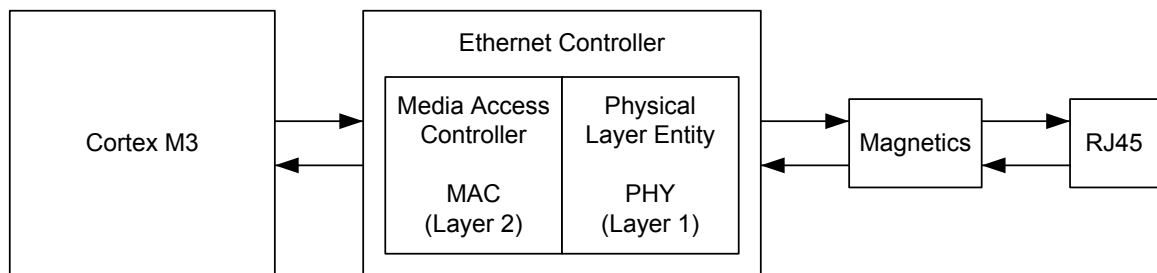

16.2.1 Internal MII Operation

For the MII management interface to function properly, the MDIO signal must be connected through a 10k Ω pull-up resistor to the +3.3 V supply. Failure to connect this pull-up resistor will prevent management transactions on this internal MII to function. Note that it is possible for data transmission across the MII to still function since the PHY layer will auto-negotiate the link parameters by default.

For the MII management interface to function properly, the internal clock must be divided down from the system clock to a frequency no greater than 2.5 MHz. The **MACMDV** register contains the divider used for scaling down the system clock. See page 422 for more details about the use of this register.

16.2.2 PHY Configuration/Operation

The Physical Layer (PHY) in the Ethernet Controller includes integrated ENDECs, scrambler/descrambler, dual-speed clock recovery, and full-featured auto-negotiation functions. The transmitter includes an on-chip pulse shaper and a low-power line driver. The receiver has an adaptive equalizer and a baseline restoration circuit required for accurate clock and data recovery. The transceiver interfaces to Category-5 unshielded twisted pair (Cat-5 UTP) cabling for 100BASE-TX applications, and Category-3 unshielded twisted pair (Cat-3 UTP) for 10BASE-T applications. The Ethernet Controller is connected to the line media via dual 1:1 isolation transformers. No external filter is required.

16.2.2.1 Clock Selection

The PHY has an on-chip crystal oscillator which can also be driven by an external oscillator. In this mode of operation, a 25-MHz crystal should be connected between the **XTALPPHY** and **XTALNPHY** pins. Alternatively, an external 25-MHz clock input can be connected to the **XTALPPHY** pin. In this mode of operation, a crystal is not required and the **XTALNPHY** pin must be tied to ground.

16.2.2.2 Auto-Negotiation

The PHY supports the auto-negotiation functions of Clause 28 of the *IEEE 802.3* standard for 10/100 Mbps operation over copper wiring. This function can be enabled via register settings. The auto-negotiation function defaults to On and the **ANEGEN** bit in the **MR0** register is High after reset. Software can disable the auto-negotiation function by writing to the **ANEGEN** bit. The contents of the **MR4** register are sent to the PHY's link partner during auto-negotiation via fast-link pulse coding.

Once auto-negotiation is complete, the **DPLX** and **RATE** bits in the **MR18** register reflect the actual speed and duplex that was chosen. If auto-negotiation fails to establish a link for any reason, the **ANEGF** bit in the **MR18** register reflects this and auto-negotiation restarts from the beginning. Writing a 1 to the **RANEG** bit in the **MR0** register also causes auto-negotiation to restart.

16.2.2.3 Polarity Correction

The PHY is capable of either automatic or manual polarity reversal for 10BASE-T and auto-negotiation functions. Bits 4 and 5 (**RVSPOL** and **APOL**) in the **MR16** register control this feature. The default is automatic mode, where **APOL** is Low and **RVSPOL** indicates if the detection circuitry has inverted the input signal. To enter manual mode, **APOL** should be set High and **RVSPOL** then controls the signal polarity.

16.2.2.4 MDI/MDI-X Configuration

The PHY supports the automatic MDI/MDI-X configuration as defined in *IEEE 802.3-2002 specification*. This eliminates the need for cross-over cables when connecting to another device, such as a hub. The algorithm is controlled via settings in the **MR24** register. Refer to page 444 for additional details about these settings.

16.2.2.5 LED Indicators

The PHY supports two LED signals that can be used to indicate various states of operation of the Ethernet Controller. These signals are mapped to the **LED0** and **LED1** pins. By default, these pins are configured as GPIO signals (**PF3** and **PF2**). For the PHY layer to drive these signals, they must be reconfigured to their hardware function. See "General-Purpose Input/Outputs (GPIOs)" on page

156 for additional details. The function of these pins is programmable via the PHY layer **MR23** register. Refer to page 443 for additional details on how to program these LED functions.

16.2.3 MAC Configuration/Operation

16.2.3.1 Ethernet Frame Format

Ethernet data is carried by Ethernet frames. The basic frame format is shown in Figure 16-3 on page 404.

Figure 16-3. Ethernet Frame

Preamble	SFD	Destination Address	Source Address	Length/ Type	Data	FCS
7 Bytes	1 Byte	6 Bytes	6 Bytes	2 Bytes	46 - 1500 Bytes	4 Bytes

The seven fields of the frame are transmitted from left to right. The bits within the frame are transmitted from least to most significant bit.

- Preamble

The Preamble field is used by the physical layer signaling circuitry to synchronize with the received frame's timing. The preamble is 7 octets long.

- Start Frame Delimiter (SFD)

The SFD field follows the preamble pattern and indicates the start of the frame. Its value is 1010.1011.

- Destination Address (DA)

This field specifies destination addresses for which the frame is intended. The LSB of the DA determines whether the address is an individual (0), or group/multicast (1) address.

- Source Address (SA)

The source address field identifies the station from which the frame was initiated.

- Length/Type Field

The meaning of this field depends on its numeric value. The first of two octets is most significant. This field can be interpreted as length or type code. The maximum length of the data field is 1500 octets. If the value of the Length/Type field is less than or equal to 1500 decimal, it indicates the number of MAC client data octets. If the value of this field is greater than or equal to 1536 decimal, then it is type interpretation. The meaning of the Length/Type field when the value is between 1500 and 1536 decimal is unspecified by the standard. The MAC module assumes type interpretation if the value of the Length/Type field is greater than 1500 decimal.

- Data

The data field is a sequence of 0 to 1500 octets. Full data transparency is provided so any values can appear in this field. A minimum frame size is required to properly meet the IEEE standard. If necessary, the data field is extended by appending extra bits (a pad). The pad field can have a size of 0 to 46 octets. The sum of the data and pad lengths must be a minimum of 46 octets. The MAC module automatically inserts pads if required, though it can be disabled by a register

write. For the MAC module core, data sent/received can be larger than 1500 bytes, and no Frame Too Long error is reported. Instead, a FIFO Overrun error is reported when the frame received is too large to fit into the Ethernet Controller's RAM.

- Frame Check Sequence (FCS)

The frame check sequence carries the cyclic redundancy check (CRC) value. The value of this field is computed over destination address, source address, length/type, data, and pad fields using the CRC-32 algorithm. The MAC module computes the FCS value one nibble at a time. For transmitted frames, this field is automatically inserted by the MAC layer, unless disabled by the `CRC` bit in the **MACTCTL** register. For received frames, this field is automatically checked. If the FCS does not pass, the frame will not be placed in the RX FIFO, unless the FCS check is disabled by the `BADCRC` bit in the **MACRCTL** register.

16.2.3.2 MAC Layer FIFOs

For Ethernet frame transmission, a 2 KB TX FIFO is provided that can be used to store a single frame. While the *IEEE 802.3 specification* limits the size of an Ethernet frame's payload section to 1500 Bytes, the Ethernet Controller places no such limit. The full buffer can be used, for a payload of up to 2032 bytes.

For Ethernet frame reception, a 2-KB RX FIFO is provided that can be used to store multiple frames, up to a maximum of 31 frames. If a frame is received and there is insufficient space in the RX FIFO, an overflow error will be indicated.

For details regarding the TX and RX FIFO layout, refer to Table 16-1 on page 405. Please note the following difference between TX and RX FIFO layout. For the TX FIFO, the Data Length field in the first FIFO word refers to the Ethernet frame data payload, as shown in the 5th to nth FIFO positions. For the RX FIFO, the Frame Length field is the total length of the received Ethernet frame, including the FCS and Frame Length bytes. Also note that if FCS generation is disabled with the `CRC` bit in the **MACTCTL** register, the last word in the FIFO must be the FCS bytes for the frame that has been written to the FIFO.

Also note that if the length of the data payload section is not a multiple of 4, the FCS field will overlap words in the FIFO. However, for the RX FIFO, the beginning of the next frame will always be on a word boundary.

Table 16-1. TX & RX FIFO Organization

FIFO Word Read/Write Sequence	Word Bit Fields	TX FIFO (Write)	RX FIFO (Read)
1st	7:0	Data Length LSB	Frame Length LSB
	15:8	Data Length MSB	Frame Length MSB
2nd	23:16		DA oct 1
	31:24		DA oct 2
	7:0		DA oct 3
	15:8		DA oct 4
3rd	23:16		DA oct 5
	31:24		DA oct 6
	7:0		SA oct 1
	15:8		SA oct 2
4th	23:16		SA oct 3
	31:24		SA oct 4

FIFO Word Read/Write Sequence	Word Bit Fields	TX FIFO (Write)	RX FIFO (Read)
4th	7:0	SA oct 5	
	15:8	SA oct 6	
	23:16	Len/Type MSB	
	31:24	Len/Type LSB	
5th to nth	7:0	data oct n	
	15:8	data oct n+1	
	23:16	data oct n+2	
	31:24	data oct n+3	
last	7:0	FCS 1 (if the CRC bit in MACCTL is 0)	FCS 1
	15:8	FCS 2 (if the CRC bit in MACCTL is 0)	FCS 2
	23:16	FCS 3 (if the CRC bit in MACCTL is 0)	FCS 3
	31:24	FCS 4 (if the CRC bit in MACCTL is 0)	FCS 4

16.2.3.3 Ethernet Transmission Options

The Ethernet Controller can automatically generate and insert the Frame Check Sequence (FCS) at the end of the transmit frame. This is controlled by the `CRC` bit in the **MACCTL** register. For test purposes, in order to generate a frame with an invalid CRC, this feature can be disabled.

The *IEEE 802.3 specification* requires that the Ethernet frame payload section be a minimum of 46 bytes. The Ethernet Controller can be configured to automatically pad the data section if the payload data section loaded into the FIFO is less than the minimum 46 bytes. This feature is controlled by the `PADEN` bit in the **MACCTL** register.

At the MAC layer, the transmitter can be configured for both full-duplex and half-duplex operation by using the `DUPLEX` bit in the **MACCTL** register.

16.2.3.4 Ethernet Reception Options

Using the `BADCRC` bit in the **MACRCTL** register, the Ethernet Controller can be configured to reject incoming Ethernet frames with an invalid FCS field.

The Ethernet receiver can also be configured for Promiscuous and Multicast modes using the `PRMS` and `AMUL` fields in the **MACRCTL** register. If these modes are not enabled, only Ethernet frames with a broadcast address, or frames matching the MAC address programmed into the **MACIA0** and **MACIA1** register will be placed into the RX FIFO.

16.2.4 Interrupts

The Ethernet Controller can generate an interrupt for one or more of the following conditions:

- A frame has been received into an empty RX FIFO
- A frame transmission error has occurred
- A frame has been transmitted successfully
- A frame has been received with no room in the RX FIFO (overrun)

- A frame has been received with one or more error conditions (for example, FCS failed)
- An MII management transaction between the MAC and PHY layers has completed
- One or more of the following PHY layer conditions occurs:
 - Auto-Negotiate Complete
 - Remote Fault
 - Link Status Change
 - Link Partner Acknowledge
 - Parallel Detect Fault
 - Page Received
 - Receive Error
 - Jabber Event Detected

16.3 Initialization and Configuration

To use the Ethernet Controller, the peripheral must be enabled by setting the `EPHY0` and `EMAC0` bits in the `RCGC2` register. The following steps can then be used to configure the Ethernet Controller for basic operation.

1. Program the `MACDIV` register to obtain a 2.5 MHz clock (or less) on the internal MII. Assuming a 20-MHz system clock, the `MACDIV` value would be 4.
2. Program the `MACIA0` and `MACIA1` register for address filtering.
3. Program the `MACTCTL` register for Auto CRC generation, padding, and full-duplex operation using a value of 0x16.
4. Program the `MACRCTL` register to reject frames with bad FCS using a value of 0x08.
5. Enable both the Transmitter and Receive by setting the LSB in both the `MACTCTL` and `MACRCTL` registers.
6. To transmit a frame, write the frame into the TX FIFO using the `MACDATA` register. Then set the `NEWTX` bit in the `MACTR` register to initiate the transmit process. When the `NEWTX` bit has been cleared, the TX FIFO will be available for the next transmit frame.
7. To receive a frame, wait for the `NPR` field in the `MACNP` register to be non-zero. Then begin reading the frame from the RX FIFO by using the `MACDATA` register. When the frame (including the FCS field) has been read, the `NPR` field should decrement by one. When there are no more frames in the RX FIFO, the `NPR` field will read 0.

16.4 Ethernet Register Map

Table 16-2 on page 408 lists the Ethernet MAC registers. All addresses given are relative to the Ethernet MAC base address of 0x4004.8000.

The *IEEE 802.3* standard specifies a register set for controlling and gathering status from the PHY. The registers are collectively known as the MII Management registers and are detailed in Section 22.2.4 of the *IEEE 802.3 specification*. Table 16-2 on page 408 also lists these MII Management registers. All addresses given are absolute and are written directly to the *REGADR* field of the **MACMCTL** register. The format of registers 0 to 15 are defined by the IEEE specification and are common to all PHY implementations. The only variance allowed is for features that may or may not be supported by a specific PHY. Registers 16 to 31 are vendor-specific registers, used to support features that are specific to a vendors PHY implementation. Vendor-specific registers not listed are reserved.

Table 16-2. Ethernet Register Map

Offset	Name	Type	Reset	Description	See page
Ethernet MAC					
0x000	MACRIS	RO	0x0000.0000	Ethernet MAC Raw Interrupt Status	410
0x000	MACIACK	W1C	0x0000.0000	Ethernet MAC Interrupt Acknowledge	412
0x004	MACIM	R/W	0x0000.007F	Ethernet MAC Interrupt Mask	413
0x008	MACRCTL	R/W	0x0000.0008	Ethernet MAC Receive Control	414
0x00C	MACTCTL	R/W	0x0000.0000	Ethernet MAC Transmit Control	415
0x010	MACDATA	R/W	0x0000.0000	Ethernet MAC Data	416
0x014	MACIA0	R/W	0x0000.0000	Ethernet MAC Individual Address 0	418
0x018	MACIA1	R/W	0x0000.0000	Ethernet MAC Individual Address 1	419
0x01C	MACTHR	R/W	0x0000.003F	Ethernet MAC Threshold	420
0x020	MACMCTL	R/W	0x0000.0000	Ethernet MAC Management Control	421
0x024	MACMDV	R/W	0x0000.0080	Ethernet MAC Management Divider	422
0x02C	MACMTXD	R/W	0x0000.0000	Ethernet MAC Management Transmit Data	423
0x030	MACMRXD	R/W	0x0000.0000	Ethernet MAC Management Receive Data	424
0x034	MACNP	RO	0x0000.0000	Ethernet MAC Number of Packets	425
0x038	MACTR	R/W	0x0000.0000	Ethernet MAC Transmission Request	426
MII Management					
-	MR0	R/W	0x3100	Ethernet PHY Management Register 0 – Control	427
-	MR1	RO	0x7849	Ethernet PHY Management Register 1 – Status	429
-	MR2	RO	0x000E	Ethernet PHY Management Register 2 – PHY Identifier 1	431
-	MR3	RO	0x7237	Ethernet PHY Management Register 3 – PHY Identifier 2	432
-	MR4	R/W	0x01E1	Ethernet PHY Management Register 4 – Auto-Negotiation Advertisement	433
-	MR5	RO	0x0000	Ethernet PHY Management Register 5 – Auto-Negotiation Link Partner Base Page Ability	435

Offset	Name	Type	Reset	Description	See page
-	MR6	RO	0x0000	Ethernet PHY Management Register 6 – Auto-Negotiation Expansion	436
-	MR16	R/W	0x0140	Ethernet PHY Management Register 16 – Vendor-Specific	437
-	MR17	R/W	0x0000	Ethernet PHY Management Register 17 – Interrupt Control/Status	439
-	MR18	RO	0x0000	Ethernet PHY Management Register 18 – Diagnostic	441
-	MR19	R/W	0x4000	Ethernet PHY Management Register 19 – Transceiver Control	442
-	MR23	R/W	0x0010	Ethernet PHY Management Register 23 – LED Configuration	443
-	MR24	R/W	0x00C0	Ethernet PHY Management Register 24 –MDI/MDIX Control	444

16.5 Ethernet MAC Register Descriptions

The remainder of this section lists and describes the Ethernet MAC registers, in numerical order by address offset. Also see “MII Management Register Descriptions” on page 426.

Register 1: Ethernet MAC Raw Interrupt Status (MACRIS), offset 0x000

The **MACRIS** register is the interrupt status register. On a read, this register gives the current status value of the corresponding interrupt prior to masking.

Ethernet MAC Raw Interrupt Status (MACRIS)

Base 0x4004.8000

Offset 0x000

Type RO, reset 0x0000.0000

	31	30	29	28	27	26	25	24	23	22	21	20	19	18	17	16	
	reserved																
Type	RO	RO	RO	RO	RO	RO	RO	RO	RO	RO	RO	RO	RO	RO	RO	RO	
Reset	0	0	0	0	0	0	0	0	0	0	0	0	0	0	0	0	
	15	14	13	12	11	10	9	8	7	6	5	4	3	2	1	0	
	reserved										PHYINT	MDINT	RXER	FOV	TXEMP	TXER	RXINT
Type	RO	RO	RO	RO	RO	RO	RO	RO	RO	RO	RO	RO	RO	RO	RO	RO	
Reset	0	0	0	0	0	0	0	0	0	0	0	0	0	0	0	0	

Bit/Field	Name	Type	Reset	Description
31:7	reserved	RO	0x0	Software should not rely on the value of a reserved bit. To provide compatibility with future products, the value of a reserved bit should be preserved across a read-modify-write operation.
6	PHYINT	RO	0x0	PHY Interrupt When set, indicates that an enabled interrupt in the PHY layer has occurred. MR17 in the PHY must be read to determine the specific PHY event that triggered this interrupt.
5	MDINT	RO	0x0	MII Transaction Complete When set, indicates that a transaction (read or write) on the MII interface has completed successfully.
4	RXER	RO	0x0	Receive Error This bit indicates that an error was encountered on the receiver. The possible errors that can cause this interrupt bit to be set are: <ul style="list-style-type: none"> ■ A receive error occurs during the reception of a frame (100 Mb/s only). ■ The frame is not an integer number of bytes (dribble bits) due to an alignment error. ■ The CRC of the frame does not pass the FCS check. ■ The length/type field is inconsistent with the frame data size when interpreted as a length field.
3	FOV	RO	0x0	FIFO Overrun When set, indicates that an overrun was encountered on the receive FIFO.
2	TXEMP	RO	0x0	Transmit FIFO Empty When set, indicates that the packet was transmitted and that the TX FIFO is empty.

Bit/Field	Name	Type	Reset	Description
1	TXER	RO	0x0	<p>Transmit Error</p> <p>When set, indicates that an error was encountered on the transmitter. The possible errors that can cause this interrupt bit to be set are:</p> <ul style="list-style-type: none">■ The data length field stored in the TX FIFO exceeds 2032. The frame is not sent when this error occurs.■ The retransmission attempts during the backoff process have exceeded the maximum limit of 16.
0	RXINT	RO	0x0	<p>Packet Received</p> <p>When set, indicates that at least one packet has been received and is stored in the receiver FIFO.</p>

Register 2: Ethernet MAC Interrupt Acknowledge (MACIACK), offset 0x000

A write of a 1 to any bit position of this register clears the corresponding interrupt bit in the **Ethernet MAC Raw Interrupt Status (MACRIS)** register.

Ethernet MAC Interrupt Acknowledge (MACIACK)

Base 0x4004.8000

Offset 0x000

Type W1C, reset 0x0000.0000

	31	30	29	28	27	26	25	24	23	22	21	20	19	18	17	16
	reserved															
Type	RO	RO	RO	RO	RO	RO	RO	RO	RO	RO	RO	RO	RO	RO	RO	RO
Reset	0	0	0	0	0	0	0	0	0	0	0	0	0	0	0	0
	15	14	13	12	11	10	9	8	7	6	5	4	3	2	1	0
	reserved									PHYINT	MDINT	RXER	FOV	TXEMP	TXER	RXINT
Type	RO	RO	RO	RO	RO	RO	RO	RO	RO	W1C	W1C	W1C	W1C	W1C	W1C	W1C
Reset	0	0	0	0	0	0	0	0	0	0	0	0	0	0	0	0

Bit/Field	Name	Type	Reset	Description
31:7	reserved	RO	0x0	Software should not rely on the value of a reserved bit. To provide compatibility with future products, the value of a reserved bit should be preserved across a read-modify-write operation.
6	PHYINT	W1C	0x0	Clear PHY Interrupt A write of a 1 clears the PHYINT interrupt read from the MACRIS register.
5	MDINT	W1C	0x0	Clear MII Transaction Complete A write of a 1 clears the MDINT interrupt read from the MACRIS register.
4	RXER	W1C	0x0	Clear Receive Error A write of a 1 clears the RXER interrupt read from the MACRIS register.
3	FOV	W1C	0x0	Clear FIFO Overrun A write of a 1 clears the FOV interrupt read from the MACRIS register.
2	TXEMP	W1C	0x0	Clear Transmit FIFO Empty A write of a 1 clears the TXEMP interrupt read from the MACRIS register.
1	TXER	W1C	0x0	Clear Transmit Error A write of a 1 clears the TXER interrupt read from the MACRIS register and resets the TX FIFO write pointer.
0	RXINT	W1C	0x0	Clear Packet Received A write of a 1 clears the RXINT interrupt read from the MACRIS register.

Register 3: Ethernet MAC Interrupt Mask (MACIM), offset 0x004

This register allows software to enable/disable Ethernet MAC interrupts. Writing a 0 disables the interrupt, while writing a 1 enables it.

Ethernet MAC Interrupt Mask (MACIM)

Base 0x4004.8000

Offset 0x004

Type R/W, reset 0x0000.007F

	31	30	29	28	27	26	25	24	23	22	21	20	19	18	17	16
	reserved															
Type	RO	RO	RO	RO	RO	RO	RO	RO	RO	RO	RO	RO	RO	RO	RO	RO
Reset	0	0	0	0	0	0	0	0	0	0	0	0	0	0	0	0
	15	14	13	12	11	10	9	8	7	6	5	4	3	2	1	0
	reserved								PHYINTM	MDINTM	RXERM	FOVM	TXEMPM	TXERM	RXINTM	
Type	RO	RO	RO	RO	RO	RO	RO	RO	RO	R/W	R/W	R/W	R/W	R/W	R/W	R/W
Reset	0	0	0	0	0	0	0	0	0	1	1	1	1	1	1	1

Bit/Field	Name	Type	Reset	Description
31:7	reserved	RO	0x0	Software should not rely on the value of a reserved bit. To provide compatibility with future products, the value of a reserved bit should be preserved across a read-modify-write operation.
6	PHYINTM	R/W	1	Mask PHY Interrupt This bit masks the PHYINT bit in the MACRIS register from being asserted.
5	MDINTM	R/W	1	Mask MII Transaction Complete This bit masks the MDINT bit in the MACRIS register from being asserted.
4	RXERM	R/W	1	Mask Receive Error This bit masks the RXER bit in the MACRIS register from being asserted.
3	FOVM	R/W	1	Mask FIFO Overrun This bit masks the FOV bit in the MACRIS register from being asserted.
2	TXEMPM	R/W	1	Mask Transmit FIFO Empty This bit masks the TXEMP bit in the MACRIS register from being asserted.
1	TXERM	R/W	1	Mask Transmit Error This bit masks the TXER bit in the MACRIS register from being asserted.
0	RXINTM	R/W	1	Mask Packet Received This bit masks the RXINT bit in the MACRIS register from being asserted.

Register 4: Ethernet MAC Receive Control (MACRCTL), offset 0x008

This register enables software to configure the receive module and control the types of frames that are received from the physical medium. It is important to note that when the receive module is enabled, all valid frames with a broadcast address of FF-FF-FF-FF-FF-FF in the Destination Address field will be received and stored in the RX FIFO, even if the `AMUL` bit is not set.

Ethernet MAC Receive Control (MACRCTL)

Base 0x4004.8000
Offset 0x008
Type R/W, reset 0x0000.0008

	31	30	29	28	27	26	25	24	23	22	21	20	19	18	17	16	
	reserved																
Type	RO	RO	RO	RO	RO	RO	RO	RO	RO	RO	RO	RO	RO	RO	RO	RO	
Reset	0	0	0	0	0	0	0	0	0	0	0	0	0	0	0	0	
	15	14	13	12	11	10	9	8	7	6	5	4	3	2	1	0	
	reserved												RSTFIFO	BADCRC	PRMS	AMUL	RXEN
Type	RO	RO	RO	RO	RO	RO	RO	RO	RO	RO	RO	R/W	R/W	R/W	R/W	R/W	
Reset	0	0	0	0	0	0	0	0	0	0	0	0	1	0	0	0	

Bit/Field	Name	Type	Reset	Description
31:5	reserved	RO	0x0	Software should not rely on the value of a reserved bit. To provide compatibility with future products, the value of a reserved bit should be preserved across a read-modify-write operation.
4	RSTFIFO	R/W	0x0	Clear Receive FIFO When set, clears the receive FIFO. This should be done when software initialization is performed. It is recommended that the receiver be disabled (<code>RXEN = 0</code>), and then the reset initiated (<code>RSTFIFO = 1</code>). This sequence will flush and reset the RX FIFO.
3	BADCRC	R/W	0x1	Enable Reject Bad CRC The <code>BADCRC</code> bit enables the rejection of frames with an incorrectly calculated CRC.
2	PRMS	R/W	0x0	Enable Promiscuous Mode The <code>PRMS</code> bit enables Promiscuous mode, which accepts all valid frames, regardless of the Destination Address.
1	AMUL	R/W	0x0	Enable Multicast Frames The <code>AMUL</code> bit enables the reception of multicast frames from the physical medium.
0	RXEN	R/W	0x0	Enable Receiver The <code>RXEN</code> bit enables the Ethernet receiver. When this bit is Low, the receiver is disabled and all frames on the physical medium are ignored.

Register 5: Ethernet MAC Transmit Control (MACTCTL), offset 0x00C

This register enables software to configure the transmit module, and control frames are placed onto the physical medium.

Ethernet MAC Transmit Control (MACTCTL)

Base 0x4004.8000
Offset 0x00C
Type R/W, reset 0x0000.0000

	31	30	29	28	27	26	25	24	23	22	21	20	19	18	17	16	
	reserved																
Type	RO	RO	RO	RO	RO	RO	RO	RO	RO	RO	RO	RO	RO	RO	RO	RO	
Reset	0	0	0	0	0	0	0	0	0	0	0	0	0	0	0	0	
	15	14	13	12	11	10	9	8	7	6	5	4	3	2	1	0	
	reserved												DUPLEX	reserved	CRC	PADEN	TXEN
Type	RO	RO	RO	RO	RO	RO	RO	RO	RO	RO	RO	R/W	RO	R/W	R/W	R/W	
Reset	0	0	0	0	0	0	0	0	0	0	0	0	0	0	0	0	

Bit/Field	Name	Type	Reset	Description
31:5	reserved	RO	0x0	Software should not rely on the value of a reserved bit. To provide compatibility with future products, the value of a reserved bit should be preserved across a read-modify-write operation.
4	DUPLEX	R/W	0x0	Enable Duplex Mode When set, enables Duplex mode, allowing simultaneous transmission and reception.
3	reserved	RO	0x0	Software should not rely on the value of a reserved bit. To provide compatibility with future products, the value of a reserved bit should be preserved across a read-modify-write operation.
2	CRC	R/W	0x0	Enable CRC Generation When set, enables the automatic generation of the CRC and the placement at the end of the packet. If this bit is not set, the frames placed in the TX FIFO will be sent exactly as they are written into the FIFO.
1	PADEN	R/W	0x0	Enable Packet Padding When set, enables the automatic padding of packets that do not meet the minimum frame size.
0	TXEN	R/W	0x0	Enable Transmitter When set, enables the transmitter. When this bit is 0, the transmitter is disabled.

Register 6: Ethernet MAC Data (MACDATA), offset 0x010

This register enables software to access the TX and RX FIFOs.

Reads from this register return the data stored in the RX FIFO from the location indicated by the read pointer.

Writes to this register store the data in the TX FIFO at the location indicated by the write pointer. The write pointer is then auto-incremented to the next TX FIFO location.

There is no mechanism for randomly accessing bytes in either the RX or TX FIFOs. Data must be read from the RX FIFO sequentially and stored in a buffer for further processing. Once a read has been performed, the data in the FIFO cannot be re-read. Data must be written to the TX FIFO sequentially. If an error is made in placing the frame into the TX FIFO, the write pointer can be reset to the start of the TX FIFO by writing the `TXER` bit of the `MACIACK` register and then the data re-written.

Read-Only Register

Ethernet MAC Data (MACDATA)

Base 0x4004.8000
 Offset 0x010
 Type RO, reset 0x0000.0000

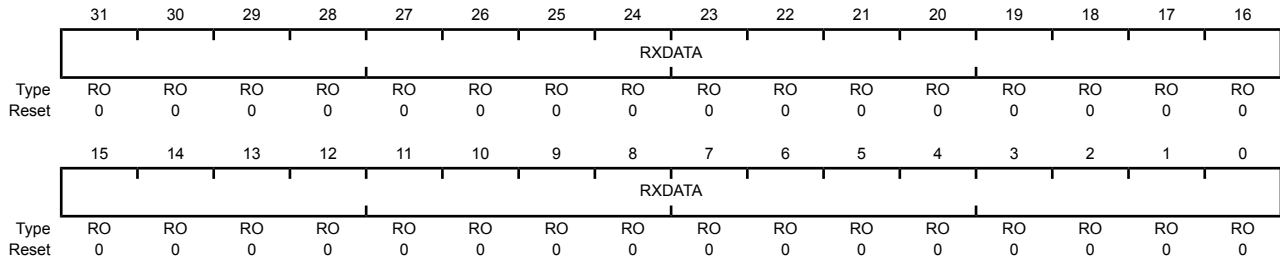

Bit/Field	Name	Type	Reset	Description
31:0	RXDATA	RO	0x0	Receive FIFO Data

The `RXDATA` bits represent the next four bytes of data stored in the RX FIFO.

Write-Only Register

Ethernet MAC Data (MACDATA)

Base 0x4004.8000
 Offset 0x010
 Type WO, reset 0x0000.0000

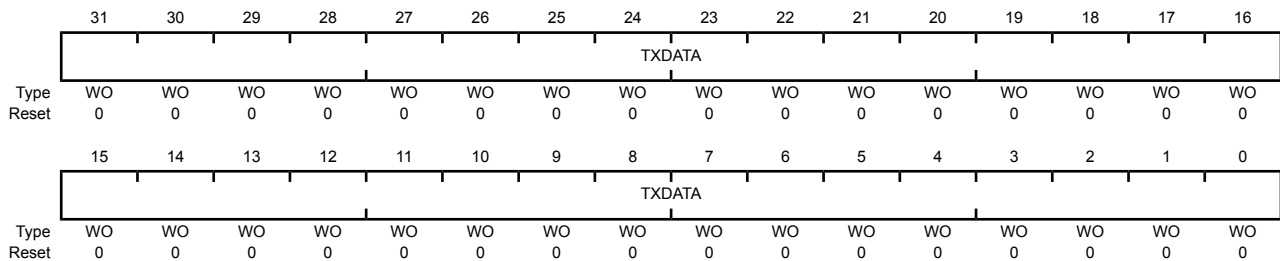

Bit/Field	Name	Type	Reset	Description
31:0	TXDATA	WO	0x0	Transmit FIFO Data The TXDATA bits represent the next four bytes of data to place in the TX FIFO for transmission.

Register 7: Ethernet MAC Individual Address 0 (MACIA0), offset 0x014

This register enables software to program the first four bytes of the hardware MAC address of the Network Interface Card (NIC). (The last two bytes are in **MACIA1**). The 6-byte IAR is compared against the incoming Destination Address fields to determine whether the frame should be received.

Ethernet MAC Individual Address 0 (MACIA0)

Base 0x4004.8000
Offset 0x014
Type R/W, reset 0x0000.0000

	31	30	29	28	27	26	25	24	23	22	21	20	19	18	17	16
	MACOCT4								MACOCT3							
Type	R/W	R/W	R/W	R/W	R/W	R/W	R/W	R/W	R/W	R/W	R/W	R/W	R/W	R/W	R/W	R/W
Reset	0	0	0	0	0	0	0	0	0	0	0	0	0	0	0	0
	15	14	13	12	11	10	9	8	7	6	5	4	3	2	1	0
	MACOCT2								MACOCT1							
Type	R/W	R/W	R/W	R/W	R/W	R/W	R/W	R/W	R/W	R/W	R/W	R/W	R/W	R/W	R/W	R/W
Reset	0	0	0	0	0	0	0	0	0	0	0	0	0	0	0	0

Bit/Field	Name	Type	Reset	Description
31:24	MACOCT4	R/W	0x0	MAC Address Octet 4 The MACOCT4 bits represent the fourth octet of the MAC address used to uniquely identify each Ethernet Controller.
23:16	MACOCT3	R/W	0x0	MAC Address Octet 3 The MACOCT3 bits represent the third octet of the MAC address used to uniquely identify each Ethernet Controller.
15:8	MACOCT2	R/W	0x0	MAC Address Octet 2 The MACOCT2 bits represent the second octet of the MAC address used to uniquely identify each Ethernet Controller.
7:0	MACOCT1	R/W	0x0	MAC Address Octet 1 The MACOCT1 bits represent the first octet of the MAC address used to uniquely identify each Ethernet Controller.

Register 8: Ethernet MAC Individual Address 1 (MACIA1), offset 0x018

This register enables software to program the last two bytes of the hardware MAC address of the Network Interface Card (NIC). (The first four bytes are in **MACIA0**). The 6-byte IAR is compared against the incoming Destination Address fields to determine whether the frame should be received.

Ethernet MAC Individual Address 1 (MACIA1)

Base 0x4004.8000
Offset 0x018
Type R/W, reset 0x0000.0000

	31	30	29	28	27	26	25	24	23	22	21	20	19	18	17	16
	reserved															
Type	RO	RO	RO	RO	RO	RO	RO	RO	RO	RO	RO	RO	RO	RO	RO	RO
Reset	0	0	0	0	0	0	0	0	0	0	0	0	0	0	0	0
	15	14	13	12	11	10	9	8	7	6	5	4	3	2	1	0
	MACOCT6								MACOCT5							
Type	R/W	R/W	R/W	R/W	R/W	R/W	R/W	R/W	R/W	R/W	R/W	R/W	R/W	R/W	R/W	R/W
Reset	0	0	0	0	0	0	0	0	0	0	0	0	0	0	0	0

Bit/Field	Name	Type	Reset	Description
31:16	reserved	RO	0x0	Software should not rely on the value of a reserved bit. To provide compatibility with future products, the value of a reserved bit should be preserved across a read-modify-write operation.
15:8	MACOCT6	R/W	0x0	MAC Address Octet 6 The MACOCT6 bits represent the sixth octet of the MAC address used to uniquely identify each Ethernet Controller.
7:0	MACOCT5	R/W	0x0	MAC Address Octet 5 The MACOCT5 bits represent the fifth octet of the MAC address used to uniquely identify each Ethernet Controller.

Register 9: Ethernet MAC Threshold (MACTHR), offset 0x01C

This register enables software to set the threshold level at which the transmission of the frame begins. If the THRESH bits are set to 0x3F, which is the reset value, transmission does not start until the NEWTX bit is set in the MACTR register. This effectively disables the early transmission feature.

Writing the THRESH bits to any value besides all 1s enables the early transmission feature. Once the byte count of data in the TX FIFO reaches this level, transmission of the frame begins. When THRESH is set to all 0s, transmission of the frame begins after 4 bytes (a single write) are stored in the TX FIFO. Each increment of the THRESH bit field waits for an additional 32 bytes of data (eight writes) to be stored in the TX FIFO. Therefore, a value of 0x01 would wait for 36 bytes of data to be written while a value of 0x02 would wait for 68 bytes to be written. In general, early transmission starts when:

$$\text{Number of Bytes} \geq 4 (\text{THRESH} \times 8 + 1)$$

Reaching the threshold level has the same effect as setting the NEWTX bit in the MACTR register. Transmission of the frame begins and then the number of bytes indicated by the Data Length field is sent out on the physical medium. Because under-run checking is not performed, it is possible that the tail pointer may reach and pass the write pointer in the TX FIFO. This causes indeterminate values to be written to the physical medium rather than the end of the frame. Therefore, sufficient bus bandwidth for writing to the TX FIFO must be guaranteed by the software.

If a frame smaller than the threshold level needs to be sent, the NEWTX bit in the MACTR register must be set with an explicit write. This initiates the transmission of the frame even though the threshold limit has not been reached.

If the threshold level is set too small, it is possible for the transmitter to underrun. If this occurs, the transmit frame is aborted, and a transmit error occurs.

Ethernet MAC Threshold (MACTHR)

Base 0x4004.8000
 Offset 0x01C
 Type R/W, reset 0x0000.003F

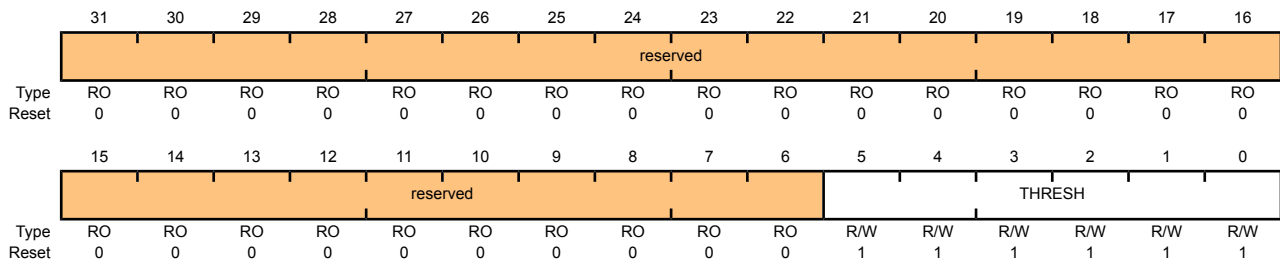

Bit/Field	Name	Type	Reset	Description
31:6	reserved	RO	0x0	Software should not rely on the value of a reserved bit. To provide compatibility with future products, the value of a reserved bit should be preserved across a read-modify-write operation.
5:0	THRESH	R/W	0x3F	Threshold Value

The THRESH bits represent the early transmit threshold. Once the amount of data in the TX FIFO exceeds this value, transmission of the packet begins.

Register 10: Ethernet MAC Management Control (MACMCTL), offset 0x020

This register enables software to control the transfer of data to and from the MII Management registers in the Ethernet PHY. The address, name, type, reset configuration, and functional description of each of these registers can be found in Table 16-2 on page 408 and in “MII Management Register Descriptions” on page 426.

In order to initiate a *read* transaction from the MII Management registers, the `WRITE` bit must be written with a 0 during the same cycle that the `START` bit is written with a 1.

In order to initiate a *write* transaction to the MII Management registers, the `WRITE` bit must be written with a 1 during the same cycle that the `START` bit is written with a 1.

Ethernet MAC Management Control (MACMCTL)

Base 0x4004.8000
Offset 0x020
Type R/W, reset 0x0000.0000

	31	30	29	28	27	26	25	24	23	22	21	20	19	18	17	16
	reserved															
Type	RO	RO	RO	RO	RO	RO	RO	RO	RO	RO	RO	RO	RO	RO	RO	RO
Reset	0	0	0	0	0	0	0	0	0	0	0	0	0	0	0	0
	15	14	13	12	11	10	9	8	7	6	5	4	3	2	1	0
	reserved								REGADR				reserved	WRITE	START	
Type	RO	RO	RO	RO	RO	RO	RO	RO	R/W	R/W	R/W	R/W	R/W	RO	R/W	R/W
Reset	0	0	0	0	0	0	0	0	0	0	0	0	0	0	0	0

Bit/Field	Name	Type	Reset	Description
31:8	reserved	RO	0x0	Software should not rely on the value of a reserved bit. To provide compatibility with future products, the value of a reserved bit should be preserved across a read-modify-write operation.
7:3	REGADR	R/W	0x0	MII Register Address The <code>REGADR</code> bit field represents the MII Management register address for the next MII management interface transaction.
2	reserved	RO	0x0	Software should not rely on the value of a reserved bit. To provide compatibility with future products, the value of a reserved bit should be preserved across a read-modify-write operation.
1	WRITE	R/W	0x0	MII Register Transaction Type The <code>WRITE</code> bit represents the operation of the next MII management interface transaction. If <code>WRITE</code> is set, the next operation will be a write; otherwise, it will be a read.
0	START	R/W	0x0	MII Register Transaction Enable The <code>START</code> bit represents the initiation of the next MII management interface transaction. When a 1 is written to this bit, the MII register located at <code>REGADR</code> will be read (<code>WRITE=0</code>) or written (<code>WRITE=1</code>).

Register 11: Ethernet MAC Management Divider (MACMDV), offset 0x024

This register enables software to set the clock divider for the Management Data Clock (MDC). This clock is used to synchronize read and write transactions between the system and the MII Management registers. The frequency of the MDC clock can be calculated from the following formula:

$$F_{\text{mdc}} = F_{\text{ipclk}} / (2 * (\text{MACMDVR} + 1))$$

The clock divider must be written with a value that ensures that the MDC clock will not exceed a frequency of 2.5 MHz.

Ethernet MAC Management Divider (MACMDV)

Base 0x4004.8000
 Offset 0x024
 Type R/W, reset 0x0000.0080

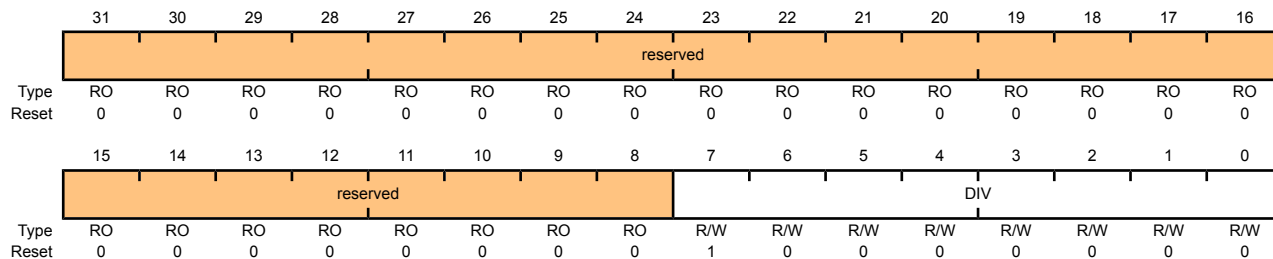

Bit/Field	Name	Type	Reset	Description
31:8	reserved	RO	0x0	Software should not rely on the value of a reserved bit. To provide compatibility with future products, the value of a reserved bit should be preserved across a read-modify-write operation.
7:0	DIV	R/W	0x80	Clock Divider The <code>DIV</code> bits are used to set the clock divider for the MDC clock used to transmit data between the MAC and PHY over the serial MII interface.

Register 12: Ethernet MAC Management Transmit Data (MACMTXD), offset 0x02C

This register holds the next value to be written to the MII Management registers.

Ethernet MAC Management Transmit Data (MACMTXD)

Base 0x4004.8000

Offset 0x02C

Type R/W, reset 0x0000.0000

	31	30	29	28	27	26	25	24	23	22	21	20	19	18	17	16
	reserved															
Type	RO	RO	RO	RO	RO	RO	RO	RO	RO	RO	RO	RO	RO	RO	RO	RO
Reset	0	0	0	0	0	0	0	0	0	0	0	0	0	0	0	0
	15	14	13	12	11	10	9	8	7	6	5	4	3	2	1	0
	MDTX															
Type	R/W	R/W	R/W	R/W	R/W	R/W	R/W	R/W	R/W	R/W	R/W	R/W	R/W	R/W	R/W	R/W
Reset	0	0	0	0	0	0	0	0	0	0	0	0	0	0	0	0

Bit/Field	Name	Type	Reset	Description
31:16	reserved	RO	0x0	Software should not rely on the value of a reserved bit. To provide compatibility with future products, the value of a reserved bit should be preserved across a read-modify-write operation.
15:0	MDTX	R/W	0x0	MII Register Transmit Data The MDTX bits represent the data that will be written in the next MII management transaction.

Register 13: Ethernet MAC Management Receive Data (MACMRXD), offset 0x030

This register holds the last value read from the MII Management registers.

Ethernet MAC Management Receive Data (MACMRXD)

Base 0x4004.8000
 Offset 0x030
 Type R/W, reset 0x0000.0000

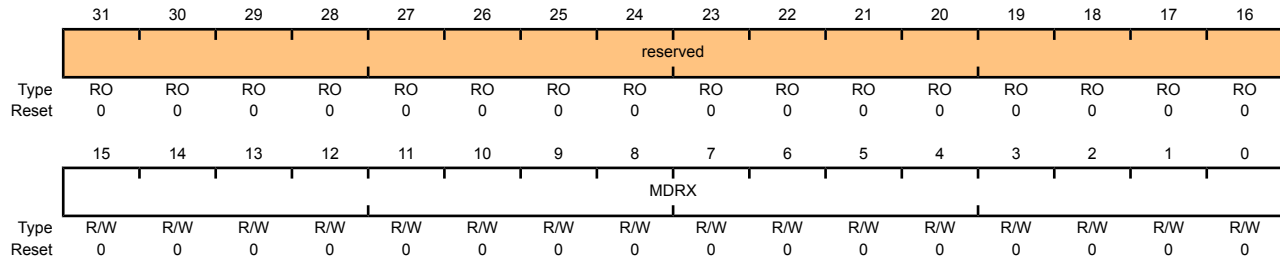

Bit/Field	Name	Type	Reset	Description
31:16	reserved	RO	0x0	Software should not rely on the value of a reserved bit. To provide compatibility with future products, the value of a reserved bit should be preserved across a read-modify-write operation.
15:0	MDRX	R/W	0x0	MII Register Receive Data The MDRX bits represent the data that was read in the previous MII management transaction.

Register 14: Ethernet MAC Number of Packets (MACNP), offset 0x034

This register holds the number of frames that are currently in the RX FIFO. When `NPR` is 0, there are no frames in the RX FIFO and the `RXINT` bit is not set. When `NPR` is any other value, there is at least one frame in the RX FIFO and the `RXINT` bit in the **MACRIS** register is set.

Ethernet MAC Number of Packets (MACNP)

Base 0x4004.8000

Offset 0x034

Type RO, reset 0x0000.0000

	31	30	29	28	27	26	25	24	23	22	21	20	19	18	17	16
	reserved															
Type	RO	RO	RO	RO	RO	RO	RO	RO	RO	RO	RO	RO	RO	RO	RO	RO
Reset	0	0	0	0	0	0	0	0	0	0	0	0	0	0	0	0
	15	14	13	12	11	10	9	8	7	6	5	4	3	2	1	0
	reserved											NPR				
Type	RO	RO	RO	RO	RO	RO	RO	RO	RO	RO	RO	RO	RO	RO	RO	RO
Reset	0	0	0	0	0	0	0	0	0	0	0	0	0	0	0	0

Bit/Field	Name	Type	Reset	Description
31:6	reserved	RO	0x0	Software should not rely on the value of a reserved bit. To provide compatibility with future products, the value of a reserved bit should be preserved across a read-modify-write operation.
5:0	NPR	RO	0x0	Number of Packets in Receive FIFO

The `NPR` bits represent the number of packets stored in the RX FIFO. While the `NPR` field is greater than 0, the `RXINT` interrupt in the **MACRIS** register will be asserted.

Register 15: Ethernet MAC Transmission Request (MACTR), offset 0x038

This register enables software to initiate the transmission of the frame currently located in the TX FIFO to the physical medium. Once the frame has been transmitted to the medium from the TX FIFO or a transmission error has been encountered, the `NEWTX` bit is auto-cleared by the hardware.

Ethernet MAC Transmission Request (MACTR)

Base 0x4004.8000
Offset 0x038
Type R/W, reset 0x0000.0000

	31	30	29	28	27	26	25	24	23	22	21	20	19	18	17	16
	reserved															
Type	RO	RO	RO	RO	RO	RO	RO	RO	RO	RO	RO	RO	RO	RO	RO	RO
Reset	0	0	0	0	0	0	0	0	0	0	0	0	0	0	0	0
	15	14	13	12	11	10	9	8	7	6	5	4	3	2	1	0
	reserved															NEWTX
Type	RO	RO	RO	RO	RO	RO	RO	RO	RO	RO	RO	RO	RO	RO	RO	R/W
Reset	0	0	0	0	0	0	0	0	0	0	0	0	0	0	0	0

Bit/Field	Name	Type	Reset	Description
31:1	reserved	RO	0x0	Software should not rely on the value of a reserved bit. To provide compatibility with future products, the value of a reserved bit should be preserved across a read-modify-write operation.
0	NEWTX	R/W	0x0	New Transmission

When set, the `NEWTX` bit initiates an Ethernet transmission once the packet has been placed in the TX FIFO. This bit is cleared once the transmission has been completed. If early transmission is being used (see the `MACTHR` register), this bit does not need to be set.

16.6 MII Management Register Descriptions

The *IEEE 802.3 standard* specifies a register set for controlling and gathering status from the PHY. The registers are collectively known as the MII Management registers. All addresses given are absolute. Addresses not listed are reserved. Also see “Ethernet MAC Register Descriptions” on page 409.

Register 16: Ethernet PHY Management Register 0 – Control (MR0), address 0x00

This register enables software to configure the operation of the PHY. The default settings of these registers are designed to initialize the PHY to a normal operational mode without configuration.

Ethernet PHY Management Register 0 – Control (MR0)

Base 0x4004.8000

Address 0x00

Type R/W, reset 0x3100

	15	14	13	12	11	10	9	8	7	6	5	4	3	2	1	0
	RESET	LOOPBK	SPEEDSL	ANEGEN	PWRDN	ISO	RANEG	DUPLEX	COLT	reserved						
Type	R/W	R/W	R/W	R/W	R/W	R/W	R/W	R/W	R/W	R/W	R/W	R/W	R/W	R/W	R/W	R/W
Reset	0	0	1	1	0	0	0	1	0	0	0	0	0	0	0	0

Bit/Field	Name	Type	Reset	Description
15	RESET	R/W	0	Reset Registers When set, resets the registers to their default state and reinitializes internal state machines. Once the reset operation has completed, this bit is cleared by hardware.
14	LOOPBK	R/W	0	Loopback Mode When set, enables the Loopback mode of operation. The receive circuitry is isolated from the physical medium and transmissions are sent back through the receive circuitry instead of the medium.
13	SPEEDSL	R/W	1	Speed Select 1: Enables the 100 Mb/s mode of operation (100BASE-TX). 0: Enables the 10 Mb/s mode of operation (10BASE-T).
12	ANEGEN	R/W	1	Auto-Negotiation Enable When set, enables the Auto-Negotiation process.
11	PWRDN	R/W	0	Power Down When set, places the PHY into a low-power consuming state.
10	ISO	R/W	0	Isolate When set, isolates transmit and receive data paths and ignores all signaling on these buses.
9	RANEG	R/W	0	Restart Auto-Negotiation When set, restarts the Auto-Negotiation process. Once the restart has initiated, this bit is cleared by hardware.
8	DUPLEX	R/W	1	Set Duplex Mode 1: Enables the Full-Duplex mode of operation. This bit can be set by software in a manual configuration process or by the Auto-Negotiation process. 0: Enables the Half-Duplex mode of operation.

Bit/Field	Name	Type	Reset	Description
7	COLT	R/W	0	Collision Test When set, enables the Collision Test mode of operation. The COLT bit asserts after the initiation of a transmission and de-asserts once the transmission is halted.
6:0	reserved	R/W	0x00	Write as 0, ignore on read.

Register 17: Ethernet PHY Management Register 1 – Status (MR1), address 0x01

This register enables software to determine the capabilities of the PHY and perform its initialization and operation appropriately.

Ethernet PHY Management Register 1 – Status (MR1)

Base 0x4004.8000

Address 0x01

Type RO, reset 0x7849

	15	14	13	12	11	10	9	8	7	6	5	4	3	2	1	0
	reserved	100X_F	100X_H	10T_F	10T_H	reserved			MFPS	ANEGC	RFAULT	ANEGA	LINK	JAB	EXTD	
Type	RO	RO	RO	RO	RO	RO	RO	RO	RO	RO	RO	RC	RO	RO	RC	RO
Reset	0	1	1	1	1	0	0	0	0	1	0	0	1	0	0	1

Bit/Field	Name	Type	Reset	Description
15	reserved	RO	0	Software should not rely on the value of a reserved bit. To provide compatibility with future products, the value of a reserved bit should be preserved across a read-modify-write operation.
14	100X_F	RO	1	100BASE-TX Full-Duplex Mode When set, indicates that the PHY is capable of supporting 100BASE-TX Full-Duplex mode.
13	100X_H	RO	1	100BASE-TX Half-Duplex Mode When set, indicates that the PHY is capable of supporting 100BASE-TX Half-Duplex mode.
12	10T_F	RO	1	10BASE-T Full-Duplex Mode When set, indicates that the PHY is capable of 10BASE-T Full-Duplex mode.
11	10T_H	RO	1	10BASE-T Half-Duplex Mode When set, indicates that the PHY is capable of supporting 10BASE-T Half-Duplex mode.
10:7	reserved	RO	0	Software should not rely on the value of a reserved bit. To provide compatibility with future products, the value of a reserved bit should be preserved across a read-modify-write operation.
6	MFPS	RO	1	Management Frames with Preamble Suppressed When set, indicates that the Management Interface is capable of receiving management frames with the preamble suppressed.
5	ANEGC	RO	0	Auto-Negotiation Complete When set, indicates that the Auto-Negotiation process has been completed and that the extended registers defined by the Auto-Negotiation protocol are valid.
4	RFAULT	RC	0	Remote Fault When set, indicates that a remote fault condition has been detected. This bit remains set until it is read, even if the condition no longer exists.

Bit/Field	Name	Type	Reset	Description
3	ANEGA	RO	1	Auto-Negotiation When set, indicates that the PHY has the ability to perform Auto-Negotiation.
2	LINK	RO	0	Link Made When set, indicates that a valid link has been established by the PHY.
1	JAB	RC	0	Jabber Condition When set, indicates that a jabber condition has been detected by the PHY. This bit remains set until it is read, even if the jabber condition no longer exists.
0	EXTD	RO	1	Extended Capabilities When set, indicates that the PHY provides an extended set of capabilities that can be accessed through the extended register set.

Register 18: Ethernet PHY Management Register 2 – PHY Identifier 1 (MR2), address 0x02

This register, along with **MR3**, provides a 32-bit value indicating the manufacturer, model, and revision information.

Ethernet PHY Management Register 2 – PHY Identifier 1 (MR2)

Base 0x4004.8000

Address 0x02

Type RO, reset 0x000E

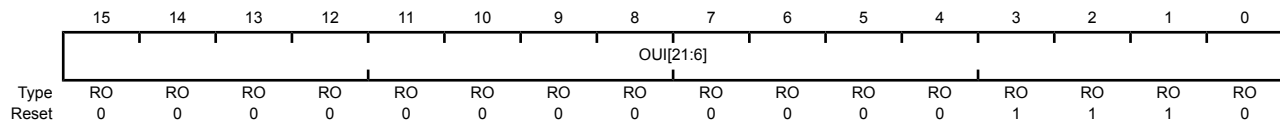

Bit/Field	Name	Type	Reset	Description
15:0	OUI[21:6]	RO	0x000E	Organizationally Unique Identifier[21:6] This field, along with the OUI[5:0] field in MR3 , makes up the Organizationally Unique Identifier indicating the PHY manufacturer.

Register 19: Ethernet PHY Management Register 3 – PHY Identifier 2 (MR3), address 0x03

This register, along with **MR2**, provides a 32-bit value indicating the manufacturer, model, and revision information.

Ethernet PHY Management Register 3 – PHY Identifier 2 (MR3)

Base 0x4004.8000
 Address 0x03
 Type RO, reset 0x7237

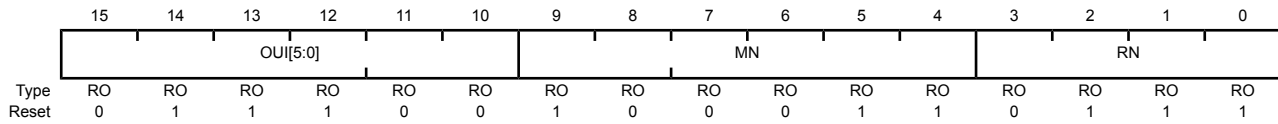

Bit/Field	Name	Type	Reset	Description
15:10	OUI[5:0]	RO	0x1C	Organizationally Unique Identifier[5:0] This field, along with the OUI [21 : 6] field in MR2 , makes up the Organizationally Unique Identifier indicating the PHY manufacturer.
9:4	MN	RO	0x23	Model Number The MN field represents the Model Number of the PHY.
3:0	RN	RO	0x7	Revision Number The RN field represents the Revision Number of the PHY.

Register 20: Ethernet PHY Management Register 4 – Auto-Negotiation Advertisement (MR4), address 0x04

This register provides the advertised abilities of the PHY used during Auto-Negotiation. Bits 8:5 represent the Technology Ability Field bits. This field can be overwritten by software to Auto-Negotiate to an alternate common technology. Writing to this register has no effect until Auto-Negotiation is re-initiated.

Ethernet PHY Management Register 4 – Auto-Negotiation Advertisement (MR4)

Base 0x4004.8000

Address 0x04

Type R/W, reset 0x01E1

	15	14	13	12	11	10	9	8	7	6	5	4	3	2	1	0
	NP	reserved	RF	reserved				A3	A2	A1	A0	S[4:0]				
Type	RO	RO	R/W	RO	RO	RO	RO	R/W	R/W	R/W	R/W	RO	RO	RO	RO	RO
Reset	0	0	0	0	0	0	0	1	1	1	1	0	0	0	0	1

Bit/Field	Name	Type	Reset	Description
15	NP	RO	0	Next Page When set, indicates the PHY is capable of Next Page exchanges to provide more detailed information on the PHY's capabilities.
14	reserved	RO	0	Software should not rely on the value of a reserved bit. To provide compatibility with future products, the value of a reserved bit should be preserved across a read-modify-write operation.
13	RF	R/W	0	Remote Fault When set, indicates to the link partner that a Remote Fault condition has been encountered.
12:9	reserved	RO	0	Software should not rely on the value of a reserved bit. To provide compatibility with future products, the value of a reserved bit should be preserved across a read-modify-write operation.
8	A3	R/W	1	Technology Ability Field[3] When set, indicates that the PHY supports the 100Base-TX full-duplex signaling protocol. If software wants to ensure that this mode is not used, this bit can be written to 0 and Auto-Negotiation re-initiated with the RANEG bit in the MRO register.
7	A2	R/W	1	Technology Ability Field[2] When set, indicates that the PHY supports the 100Base-T half-duplex signaling protocol. If software wants to ensure that this mode is not used, this bit can be written to 0 and Auto-Negotiation re-initiated.
6	A1	R/W	1	Technology Ability Field[1] When set, indicates that the PHY supports the 10Base-T full-duplex signaling protocol. If software wants to ensure that this mode is not used, this bit can be written to 0 and Auto-Negotiation re-initiated.
5	A0	R/W	1	Technology Ability Field[0] When set, indicates that the PHY supports the 10Base-T half-duplex signaling protocol. If software wants to ensure that this mode is not used, this bit can be written to 0 and Auto-Negotiation re-initiated.

Bit/Field	Name	Type	Reset	Description
4:0	S[4:0]	RO	0x01	Selector Field The S[4:0] field encodes 32 possible messages for communicating between PHYs. This field is hard-coded to 0x01, indicating that the Stellaris® PHY is <i>IEEE 802.3</i> compliant.

Register 21: Ethernet PHY Management Register 5 – Auto-Negotiation Link Partner Base Page Ability (MR5), address 0x05

This register provides the advertised abilities of the link partner's PHY that are received and stored during Auto-Negotiation.

Ethernet PHY Management Register 5 – Auto-Negotiation Link Partner Base Page Ability (MR5)

Base 0x4004.8000

Address 0x05

Type RO, reset 0x0000

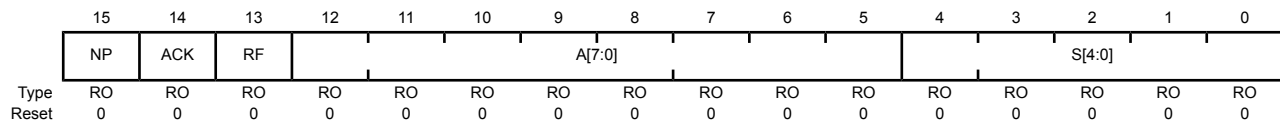

Bit/Field	Name	Type	Reset	Description														
15	NP	RO	0	Next Page When set, indicates that the link partner's PHY is capable of Next page exchanges to provide more detailed information on the PHY's capabilities.														
14	ACK	RO	0	Acknowledge When set, indicates that the device has successfully received the link partner's advertised abilities during Auto-Negotiation.														
13	RF	RO	0	Remote Fault Used as a standard transport mechanism for transmitting simple fault information.														
12:5	A[7:0]	RO	0x00	Technology Ability Field The A[7:0] field encodes individual technologies that are supported by the PHY. See the MR4 register.														
4:0	S[4:0]	RO	0x00	Selector Field The S[4:0] field encodes possible messages for communicating between PHYs. <table border="1"> <thead> <tr> <th>Value</th> <th>Description</th> </tr> </thead> <tbody> <tr> <td>0x00</td> <td>Reserved</td> </tr> <tr> <td>0x01</td> <td>IEEE Std 802.3</td> </tr> <tr> <td>0x02</td> <td>IEEE Std 802.9 ISLAN-16T</td> </tr> <tr> <td>0x03</td> <td>IEEE Std 802.5</td> </tr> <tr> <td>0x04</td> <td>IEEE Std 1394</td> </tr> <tr> <td>0x05–0x1F</td> <td>Reserved</td> </tr> </tbody> </table>	Value	Description	0x00	Reserved	0x01	IEEE Std 802.3	0x02	IEEE Std 802.9 ISLAN-16T	0x03	IEEE Std 802.5	0x04	IEEE Std 1394	0x05–0x1F	Reserved
Value	Description																	
0x00	Reserved																	
0x01	IEEE Std 802.3																	
0x02	IEEE Std 802.9 ISLAN-16T																	
0x03	IEEE Std 802.5																	
0x04	IEEE Std 1394																	
0x05–0x1F	Reserved																	

Register 22: Ethernet PHY Management Register 6 – Auto-Negotiation Expansion (MR6), address 0x06

This register enables software to determine the Auto-Negotiation and Next Page capabilities of the PHY and the link partner after Auto-Negotiation.

Ethernet PHY Management Register 6 – Auto-Negotiation Expansion (MR6)

Base 0x4004.8000

Address 0x06

Type RO, reset 0x0000

	15	14	13	12	11	10	9	8	7	6	5	4	3	2	1	0
	reserved											PDF	LPNPA	reserved	PRX	LPANEGA
Type	RO	RO	RO	RO	RO	RO	RO	RO	RO	RO	RO	RC	RO	RO	RC	RO
Reset	0	0	0	0	0	0	0	0	0	0	0	0	0	0	0	0

Bit/Field	Name	Type	Reset	Description
15:5	reserved	RO	0x000	Software should not rely on the value of a reserved bit. To provide compatibility with future products, the value of a reserved bit should be preserved across a read-modify-write operation.
4	PDF	RC	0	Parallel Detection Fault When set, indicates that more than one technology has been detected at link up. This bit is cleared when read.
3	LPNPA	RO	0	Link Partner is Next Page Able When set, indicates that the link partner is Next Page Able.
2	reserved	RO	0x000	Software should not rely on the value of a reserved bit. To provide compatibility with future products, the value of a reserved bit should be preserved across a read-modify-write operation.
1	PRX	RC	0	New Page Received When set, indicates that a New Page has been received from the link partner and stored in the appropriate location. This bit remains set until the register is read.
0	LPANEGA	RO	0	Link Partner is Auto-Negotiation Able When set, indicates that the Link partner is Auto-Negotiation Able.

Register 23: Ethernet PHY Management Register 16 – Vendor-Specific (MR16), address 0x10

This register enables software to configure the operation of vendor-specific modes of the PHY.

Ethernet PHY Management Register 16 – Vendor-Specific (MR16)

Base 0x4004.8000

Address 0x10

Type R/W, reset 0x0140

	15	14	13	12	11	10	9	8	7	6	5	4	3	2	1	0
	RPTR	INPOL	reserved	TXHIM	SQEI	NL10	reserved			APOL	RVSPOL	reserved	PCSBP	RXCC		
Type	R/W	R/W	RO	R/W	R/W	R/W	RO	RO	RO	RO	R/W	R/W	RO	RO	R/W	R/W
Reset	0	0	0	0	0	0	0	1	0	1	0	0	0	0	0	0

Bit/Field	Name	Type	Reset	Description
15	RPTR	R/W	0	<p>Repeater Mode</p> <p>When set, enables the repeater mode of operation. In this mode, full-duplex is not allowed and the Carrier Sense signal only responds to receive activity. If the PHY is configured to 10Base-T mode, the SQE test function is disabled.</p>
14	INPOL	R/W	0	<p>Interrupt Polarity</p> <p>1: Sets the polarity of the PHY interrupt to be active High.</p> <p>0: Sets the polarity of the PHY interrupt to active Low.</p> <p>Important: Because the Media Access Controller expects active Low interrupts from the PHY, this bit must always be written with a 0 to ensure proper operation.</p>
13	reserved	RO	0	Software should not rely on the value of a reserved bit. To provide compatibility with future products, the value of a reserved bit should be preserved across a read-modify-write operation.
12	TXHIM	R/W	0	<p>Transmit High Impedance Mode</p> <p>When set, enables the transmitter High Impedance mode. In this mode, the TXOP and TXON transmitter pins are put into a high impedance state. The RXIP and RXIN pins remain fully functional.</p>
11	SQEI	R/W	0	<p>SQE Inhibit Testing</p> <p>When set, prohibits 10Base-T SQE testing.</p> <p>When 0, the SQE testing is performed by generating a Collision pulse following the completion of the transmission of a frame.</p>
10	NL10	R/W	0	<p>Natural Loopback Mode</p> <p>When set, enables the 10Base-T Natural Loopback mode. This causes the transmission data received by the PHY to be looped back onto the receive data path when 10Base-T mode is enabled.</p>
9:6	reserved	RO	0x05	Software should not rely on the value of a reserved bit. To provide compatibility with future products, the value of a reserved bit should be preserved across a read-modify-write operation.

Bit/Field	Name	Type	Reset	Description
5	APOL	R/W	0	<p>Auto-Polarity Disable</p> <p>When set, disables the PHY's auto-polarity function.</p> <p>If this bit is 0, the PHY automatically inverts the received signal due to a wrong polarity connection during Auto-Negotiation if the PHY is in 10Base-T mode.</p>
4	RVSPOL	R/W	0	<p>Receive Data Polarity</p> <p>This bit indicates whether the receive data pulses are being inverted.</p> <p>If the APOL bit is 0, then the RVSPOL bit is read-only and indicates whether the auto-polarity circuitry is reversing the polarity. In this case, a 1 in the RVSPOL bit indicates that the receive data is inverted while a 0 indicates that the receive data is not inverted.</p> <p>If the APOL bit is 1, then the RVSPOL bit is writable and software can force the receive data to be inverted. Setting RVSPOL to 1 forces the receive data to be inverted while a 0 does not invert the receive data.</p>
3:2	reserved	RO	0	<p>Software should not rely on the value of a reserved bit. To provide compatibility with future products, the value of a reserved bit should be preserved across a read-modify-write operation.</p>
1	PCSBP	R/W	0	<p>PCS Bypass</p> <p>When set, enables the bypass of the PCS and scrambling/descrambling functions in 100Base-TX mode. This mode is only valid when Auto-Negotiation is disabled and 100Base-T mode is enabled.</p>
0	RXCC	R/W	0	<p>Receive Clock Control</p> <p>When set, enables the Receive Clock Control power saving mode if the PHY is configured in 100Base-TX mode. This mode shuts down the receive clock when no data is being received from the physical medium to save power. This mode should not be used when PCSBP is enabled and is automatically disabled when the LOOPBK bit in the MRO register is set.</p>

Register 24: Ethernet PHY Management Register 17 – Interrupt Control/Status (MR17), address 0x11

This register provides the means for controlling and observing the events, which trigger a PHY interrupt in the **MACRIS** register. This register can also be used in a polling mode via the MII Serial Interface as a means to observe key events within the PHY via one register address. Bits 0 through 7 are status bits, which are each set to logic 1 based on an event. These bits are cleared after the register is read. Bits 8 through 15 of this register, when set to logic 1, enable their corresponding bit in the lower byte to signal a PHY interrupt in the **MACRIS** register.

Ethernet PHY Management Register 17 – Interrupt Control/Status (MR17)

Base 0x4004.8000

Address 0x11

Type R/W, reset 0x0000

	15	14	13	12	11	10	9	8	7	6	5	4	3	2	1	0
	JABBER_IE	RXER_IE	PRX_IE	PDF_IE	LPACK_IE	LSCHG_IE	RFAULT_IE	ANEGCOMP_IE	JABBER_INT	RXER_INT	PRX_INT	PDF_INT	LPACK_INT	LSCHG_INT	RFAULT_INT	ANEGCOMP_INT
Type	R/W	R/W	R/W	R/W	R/W	R/W	R/W	R/W	RC	RC	RC	RC	RC	RC	RC	RC
Reset	0	0	0	0	0	0	0	0	0	0	0	0	0	0	0	0

Bit/Field	Name	Type	Reset	Description
15	JABBER_IE	R/W	0	Jabber Interrupt Enable When set, enables system interrupts when a Jabber condition is detected by the PHY.
14	RXER_IE	R/W	0	Receive Error Interrupt Enable When set, enables system interrupts when a receive error is detected by the PHY.
13	PRX_IE	R/W	0	Page Received Interrupt Enable When set, enables system interrupts when a new page is received by the PHY.
12	PDF_IE	R/W	0	Parallel Detection Fault Interrupt Enable When set, enables system interrupts when a Parallel Detection Fault is detected by the PHY.
11	LPACK_IE	R/W	0	LP Acknowledge Interrupt Enable When set, enables system interrupts when FLP bursts are received with the Acknowledge bit during Auto-Negotiation.
10	LSCHG_IE	R/W	0	Link Status Change Interrupt Enable When set, enables system interrupts when the Link Status changes from OK to FAIL.
9	RFAULT_IE	R/W	0	Remote Fault Interrupt Enable When set, enables system interrupts when a Remote Fault condition is signaled by the link partner.
8	ANEGCOMP_IE	R/W	0	Auto-Negotiation Complete Interrupt Enable When set, enables system interrupts when the Auto-Negotiation sequence has completed successfully.

Bit/Field	Name	Type	Reset	Description
7	JABBER_INT	RC	0	Jabber Event Interrupt When set, indicates that a Jabber event has been detected by the 10Base-T circuitry.
6	RXER_INT	RC	0	Receive Error Interrupt When set, indicates that a receive error has been detected by the PHY.
5	PRX_INT	RC	0	Page Receive Interrupt When set, indicates that a new page has been received from the link partner during Auto-Negotiation.
4	PDF_INT	RC	0	Parallel Detection Fault Interrupt When set, indicates that a Parallel Detection Fault has been detected by the PHY during the Auto-Negotiation process.
3	LPACK_INT	RC	0	LP Acknowledge Interrupt When set, indicates that an FLP burst has been received with the Acknowledge bit set during Auto-Negotiation.
2	LSCHG_INT	RC	0	Link Status Change Interrupt When set, indicates that the link status has changed from OK to FAIL.
1	RFAULT_INT	RC	0	Remote Fault Interrupt When set, indicates that a Remote Fault condition has been signaled by the link partner.
0	ANEGCOMP_INT	RC	0	Auto-Negotiation Complete Interrupt When set, indicates that the Auto-Negotiation sequence has completed successfully.

Register 25: Ethernet PHY Management Register 18 – Diagnostic (MR18), address 0x12

This register enables software to diagnose the results of the previous Auto-Negotiation.

Ethernet PHY Management Register 18 – Diagnostic (MR18)

Base 0x4004.8000

Address 0x12

Type RO, reset 0x0000

	15	14	13	12	11	10	9	8	7	6	5	4	3	2	1	0
	reserved			ANEGF	DPLX	RATE	RXSD	RX_LOCK	reserved							
Type	RO	RO	RO	RC	RO	RO	RO	RO	RO	RO	RO	RO	RO	RO	RO	RO
Reset	0	0	0	0	0	0	0	0	0	0	0	0	0	0	0	0

Bit/Field	Name	Type	Reset	Description
15:13	reserved	RO	0	Software should not rely on the value of a reserved bit. To provide compatibility with future products, the value of a reserved bit should be preserved across a read-modify-write operation.
12	ANEGF	RC	0	Auto-Negotiation Failure When set, indicates that no common technology was found during Auto-Negotiation and has failed. This bit remains set until read.
11	DPLX	RO	0	Duplex Mode When set, indicates that Full-Duplex was the highest common denominator found during the Auto-Negotiation process. Otherwise, Half-Duplex was the highest common denominator found.
10	RATE	RO	0	Rate When set, indicates that 100Base-TX was the highest common denominator found during the Auto-Negotiation process. Otherwise, 10Base-TX was the highest common denominator found.
9	RXSD	RO	0	Receive Detection When set, indicates that receive signal detection has occurred (in 100Base-TX mode) or that Manchester-encoded data has been detected (in 10Base-T mode).
8	RX_LOCK	RO	0	Receive PLL Lock When set, indicates that the Receive PLL has locked onto the receive signal for the selected speed of operation (10Base-T or 100Base-TX).
7:0	reserved	RO	00	Software should not rely on the value of a reserved bit. To provide compatibility with future products, the value of a reserved bit should be preserved across a read-modify-write operation.

Register 26: Ethernet PHY Management Register 19 – Transceiver Control (MR19), address 0x13

This register enables software to set the gain of the transmit output to compensate for transformer loss.

Ethernet PHY Management Register 19 – Transceiver Control (MR19)

Base 0x4004.8000

Address 0x13

Type R/W, reset 0x4000

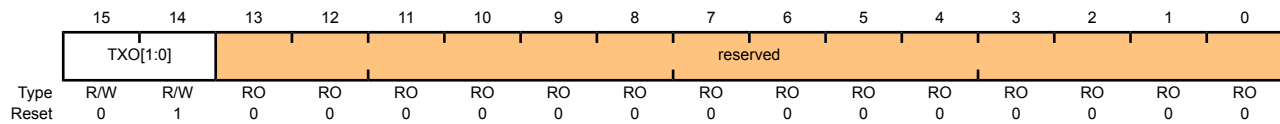

Bit/Field	Name	Type	Reset	Description
15:14	TXO[1:0]	R/W	1	<p>Transmit Amplitude Selection</p> <p>The TXO[1:0] field sets the transmit output amplitude to account for transmit transformer insertion loss.</p> <p>Value Description</p> <p>0x0 Gain set for 0.0dB of insertion loss</p> <p>0x1 Gain set for 0.4dB of insertion loss</p> <p>0x2 Gain set for 0.8dB of insertion loss</p> <p>0x3 Gain set for 1.2dB of insertion loss</p>
13:0	reserved	RO	0x0	Software should not rely on the value of a reserved bit. To provide compatibility with future products, the value of a reserved bit should be preserved across a read-modify-write operation.

Register 27: Ethernet PHY Management Register 23 – LED Configuration (MR23), address 0x17

This register enables software to select the source that will cause the LEDs to toggle.

Ethernet PHY Management Register 23 – LED Configuration (MR23)

Base 0x4004.8000

Address 0x17

Type R/W, reset 0x0010

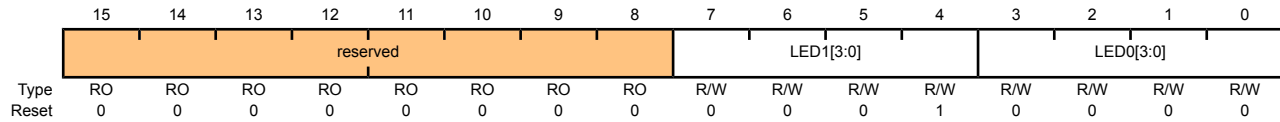

Bit/Field	Name	Type	Reset	Description																				
15:8	reserved	RO	0x0	Software should not rely on the value of a reserved bit. To provide compatibility with future products, the value of a reserved bit should be preserved across a read-modify-write operation.																				
7:4	LED1[3:0]	R/W	1	<p>LED1 Source</p> <p>The LED1 field selects the source that will toggle the LED1 signal.</p> <table border="1"> <thead> <tr> <th>Value</th> <th>Description</th> </tr> </thead> <tbody> <tr><td>0x0</td><td>Link OK</td></tr> <tr><td>0x1</td><td>RX or TX Activity (Default LED1)</td></tr> <tr><td>0x2</td><td>TX Activity</td></tr> <tr><td>0x3</td><td>RX Activity</td></tr> <tr><td>0x4</td><td>Collision</td></tr> <tr><td>0x5</td><td>100BASE-TX mode</td></tr> <tr><td>0x6</td><td>10BASE-T mode</td></tr> <tr><td>0x7</td><td>Full-Duplex</td></tr> <tr><td>0x8</td><td>Link OK & Blink=RX or TX Activity</td></tr> </tbody> </table>	Value	Description	0x0	Link OK	0x1	RX or TX Activity (Default LED1)	0x2	TX Activity	0x3	RX Activity	0x4	Collision	0x5	100BASE-TX mode	0x6	10BASE-T mode	0x7	Full-Duplex	0x8	Link OK & Blink=RX or TX Activity
Value	Description																							
0x0	Link OK																							
0x1	RX or TX Activity (Default LED1)																							
0x2	TX Activity																							
0x3	RX Activity																							
0x4	Collision																							
0x5	100BASE-TX mode																							
0x6	10BASE-T mode																							
0x7	Full-Duplex																							
0x8	Link OK & Blink=RX or TX Activity																							
3:0	LED0[3:0]	R/W	0	<p>LED0 Source</p> <p>The LED0 field selects the source that will toggle the LED0 signal.</p> <table border="1"> <thead> <tr> <th>Value</th> <th>Description</th> </tr> </thead> <tbody> <tr><td>0x0</td><td>Link OK (Default LED0)</td></tr> <tr><td>0x1</td><td>RX or TX Activity</td></tr> <tr><td>0x2</td><td>TX Activity</td></tr> <tr><td>0x3</td><td>RX Activity</td></tr> <tr><td>0x4</td><td>Collision</td></tr> <tr><td>0x5</td><td>100BASE-TX mode</td></tr> <tr><td>0x6</td><td>10BASE-T mode</td></tr> <tr><td>0x7</td><td>Full-Duplex</td></tr> <tr><td>0x8</td><td>Link OK & Blink=RX or TX Activity</td></tr> </tbody> </table>	Value	Description	0x0	Link OK (Default LED0)	0x1	RX or TX Activity	0x2	TX Activity	0x3	RX Activity	0x4	Collision	0x5	100BASE-TX mode	0x6	10BASE-T mode	0x7	Full-Duplex	0x8	Link OK & Blink=RX or TX Activity
Value	Description																							
0x0	Link OK (Default LED0)																							
0x1	RX or TX Activity																							
0x2	TX Activity																							
0x3	RX Activity																							
0x4	Collision																							
0x5	100BASE-TX mode																							
0x6	10BASE-T mode																							
0x7	Full-Duplex																							
0x8	Link OK & Blink=RX or TX Activity																							

Register 28: Ethernet PHY Management Register 24 –MDI/MDIX Control (MR24), address 0x18

This register enables software to control the behavior of the MDI/MDIX mux and its switching capabilities.

Ethernet PHY Management Register 24 –MDI/MDIX Control (MR24)

Base 0x4004.8000

Address 0x18

Type R/W, reset 0x00C0

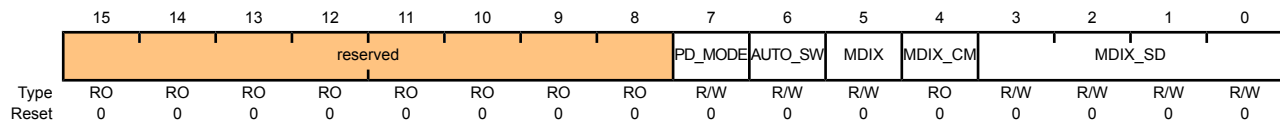

Bit/Field	Name	Type	Reset	Description
15:8	reserved	RO	0x0	Software should not rely on the value of a reserved bit. To provide compatibility with future products, the value of a reserved bit should be preserved across a read-modify-write operation.
7	PD_MODE	R/W	0	Parallel Detection Mode When set, enables the Parallel Detection mode and allows auto-switching to work when Auto-Negotiation is not enabled.
6	AUTO_SW	R/W	0	Auto-Switching Enable When set, enables Auto-Switching of the MDI/MDIX mux.
5	MDIX	R/W	0	Auto-Switching Configuration When set, indicates that the MDI/MDIX mux is in the crossover (MDIX) configuration. When 0, it indicates that the mux is in the pass-through (MDI) configuration. When the AUTO_SW bit is 1, the MDIX bit is read-only. When the AUTO_SW bit is 0, the MDIX bit is read/write and can be configured manually.
4	MDIX_CM	RO	0	Auto-Switching Complete When set, indicates that the auto-switching sequence has completed. If 0, it indicates that the sequence has not completed or that auto-switching is disabled.
3:0	MDIX_SD	R/W	0	Auto-Switching Seed This field provides the initial seed for the switching algorithm. This seed directly affects the number of attempts [5,4] respectively to write bits [3:0]. A 0 sets the seed to 0x5.

17 Pulse Width Modulator (PWM)

Pulse width modulation (PWM) is a powerful technique for digitally encoding analog signal levels. High-resolution counters are used to generate a square wave, and the duty cycle of the square wave is modulated to encode an analog signal. Typical applications include switching power supplies and motor control.

The Stellaris[®] PWM module consists of one PWM generator block and a control block. The PWM generator block contains one timer (16-bit down or up/down counter), two PWM comparators, a PWM signal generator, a dead-band generator, and an interrupt/ADC-trigger selector. The control block determines the polarity of the PWM signals, and which signals are passed through to the pins.

The PWM generator block produces two PWM signals that can either be independent signals (other than being based on the same timer and therefore having the same frequency) or a single pair of complementary signals with dead-band delays inserted. The output of the PWM generation block is managed by the output control block before being passed to the device pins.

The Stellaris[®] PWM module provides a great deal of flexibility. It can generate simple PWM signals, such as those required by a simple charge pump. It can also generate paired PWM signals with dead-band delays, such as those required by a half-H bridge driver.

17.1 Block Diagram

Figure 17-1 on page 445 provides a block diagram of a Stellaris[®] PWM module. The LM3S6916 controller contains one generator block (PWM0) and generates two independent PWM signals or one paired PWM signal with dead-band delays inserted.

Figure 17-1. PWM Module Block Diagram

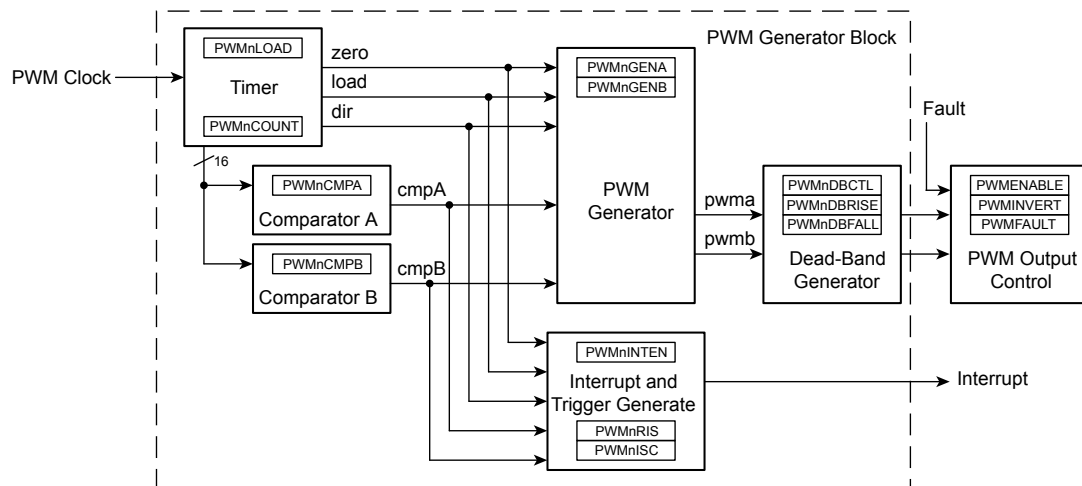

17.2 Functional Description

17.2.1 PWM Timer

The timer runs in one of two modes: Count-Down mode or Count-Up/Down mode. In Count-Down mode, the timer counts from the load value to zero, goes back to the load value, and continues counting down. In Count-Up/Down mode, the timer counts from zero up to the load value, back down to zero, back up to the load value, and so on. Generally, Count-Down mode is used for

generating left- or right-aligned PWM signals, while the Count-Up/Down mode is used for generating center-aligned PWM signals.

The timers output three signals that are used in the PWM generation process: the direction signal (this is always Low in Count-Down mode, but alternates between Low and High in Count-Up/Down mode), a single-clock-cycle-width High pulse when the counter is zero, and a single-clock-cycle-width High pulse when the counter is equal to the load value. Note that in Count-Down mode, the zero pulse is immediately followed by the load pulse.

17.2.2 PWM Comparators

There are two comparators in the PWM generator that monitor the value of the counter; when either match the counter, they output a single-clock-cycle-width High pulse. When in Count-Up/Down mode, these comparators match both when counting up and when counting down; they are therefore qualified by the counter direction signal. These qualified pulses are used in the PWM generation process. If either comparator match value is greater than the counter load value, then that comparator never outputs a High pulse.

Figure 17-2 on page 446 shows the behavior of the counter and the relationship of these pulses when the counter is in Count-Down mode. Figure 17-3 on page 447 shows the behavior of the counter and the relationship of these pulses when the counter is in Count-Up/Down mode.

Figure 17-2. PWM Count-Down Mode

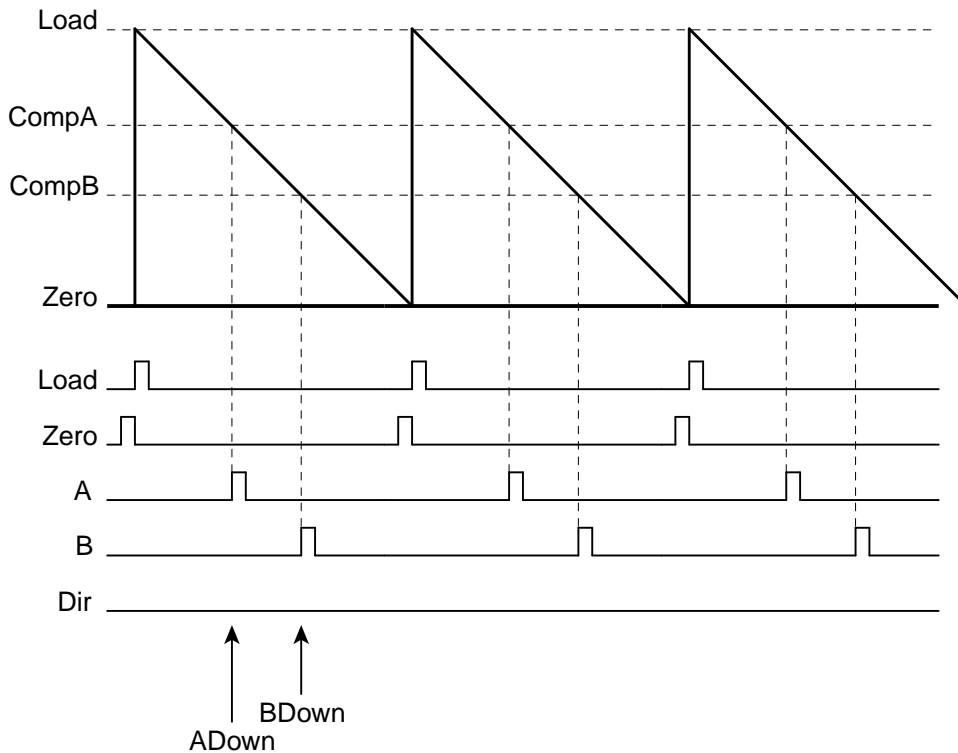
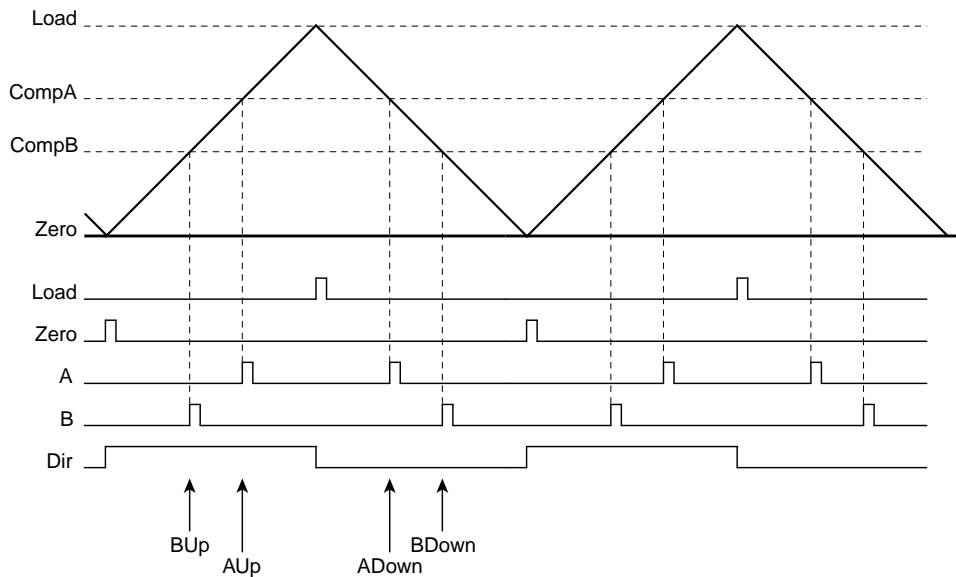
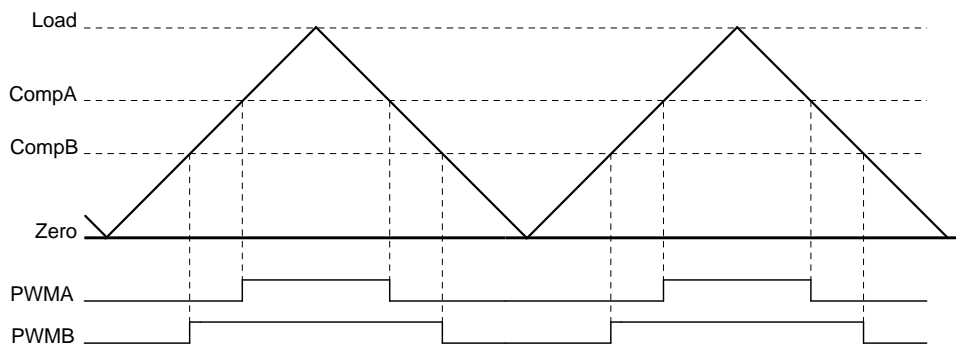

Figure 17-3. PWM Count-Up/Down Mode

17.2.3 PWM Signal Generator

The PWM generator takes these pulses (qualified by the direction signal), and generates two PWM signals. In Count-Down mode, there are four events that can affect the PWM signal: zero, load, match A down, and match B down. In Count-Up/Down mode, there are six events that can affect the PWM signal: zero, load, match A down, match A up, match B down, and match B up. The match A or match B events are ignored when they coincide with the zero or load events. If the match A and match B events coincide, the first signal, $PWMA$, is generated based only on the match A event, and the second signal, $PWMB$, is generated based only on the match B event.

For each event, the effect on each output PWM signal is programmable: it can be left alone (ignoring the event), it can be toggled, it can be driven Low, or it can be driven High. These actions can be used to generate a pair of PWM signals of various positions and duty cycles, which do or do not overlap. Figure 17-4 on page 447 shows the use of Count-Up/Down mode to generate a pair of center-aligned, overlapped PWM signals that have different duty cycles.

Figure 17-4. PWM Generation Example In Count-Up/Down Mode

In this example, the first generator is set to drive High on match A up, drive Low on match A down, and ignore the other four events. The second generator is set to drive High on match B up, drive Low on match B down, and ignore the other four events. Changing the value of comparator A

changes the duty cycle of the $PWMA$ signal, and changing the value of comparator B changes the duty cycle of the $PWMB$ signal.

17.2.4 Dead-Band Generator

The two PWM signals produced by the PWM generator are passed to the dead-band generator. If disabled, the PWM signals simply pass through unmodified. If enabled, the second PWM signal is lost and two PWM signals are generated based on the first PWM signal. The first output PWM signal is the input signal with the rising edge delayed by a programmable amount. The second output PWM signal is the inversion of the input signal with a programmable delay added between the falling edge of the input signal and the rising edge of this new signal.

This is therefore a pair of active High signals where one is always High, except for a programmable amount of time at transitions where both are Low. These signals are therefore suitable for driving a half-H bridge, with the dead-band delays preventing shoot-through current from damaging the power electronics. Figure 17-5 on page 448 shows the effect of the dead-band generator on an input PWM signal.

Figure 17-5. PWM Dead-Band Generator

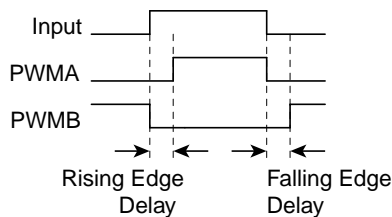

17.2.5 Interrupt/ADC-Trigger Selector

The PWM generator also takes the same four (or six) counter events and uses them to generate an interrupt or an ADC trigger. Any of these events or a set of these events can be selected as a source for an interrupt; when any of the selected events occur, an interrupt is generated. Additionally, the same event, a different event, the same set of events, or a different set of events can be selected as a source for an ADC trigger; when any of these selected events occur, an ADC trigger pulse is generated. The selection of events allows the interrupt or ADC trigger to occur at a specific position within the PWM signal. Note that interrupts and ADC triggers are based on the raw events; delays in the PWM signal edges caused by the dead-band generator are not taken into account.

17.2.6 Synchronization Methods

There is a global reset capability that can reset the counter of the PWM generator.

The counter load values and comparator match values of the PWM generator can be updated in two ways. The first is immediate update mode, where a new value is used as soon as the counter reaches zero. By waiting for the counter to reach zero, a guaranteed behavior is defined, and overly short or overly long output PWM pulses are prevented.

The other update method is synchronous, where the new value is not used until a global synchronized update signal is asserted, at which point the new value is used as soon as the counter reaches zero. This second mode allows multiple items to be updated simultaneously without odd effects during the update; everything runs from the old values until a point at which they all run from the new values.

17.2.7 Fault Conditions

There are two external conditions that affect the PWM block; the signal input on the Fault pin and the stalling of the controller by a debugger. There are two mechanisms available to handle such conditions: the output signals can be forced into an inactive state and/or the PWM timers can be stopped.

Each output signal has a fault bit. If set, a fault input signal causes the corresponding output signal to go into the inactive state. If the inactive state is a safe condition for the signal to be in for an extended period of time, this keeps the output signal from driving the outside world in a dangerous manner during the fault condition. A fault condition can also generate a controller interrupt.

Each PWM generator can also be configured to stop counting during a stall condition. The user can select for the counters to run until they reach zero then stop, or to continue counting and reloading. A stall condition does not generate a controller interrupt.

17.2.8 Output Control Block

With the PWM generator block producing two raw PWM signals, the output control block takes care of the final conditioning of the PWM signals before they go to the pins. Via a single register, the set of PWM signals that are actually enabled to the pins can be modified; this can be used, for example, to perform commutation of a brushless DC motor with a single register write (and without modifying the individual PWM generators, which are modified by the feedback control loop). Similarly, fault control can disable any of the PWM signals as well. A final inversion can be applied to any of the PWM signals, making them active Low instead of the default active High.

17.3 Initialization and Configuration

The following example shows how to initialize the PWM Generator 0 with a 25-KHz frequency, and with a 25% duty cycle on the `PWM0` pin and a 75% duty cycle on the `PWM1` pin. This example assumes the system clock is 20 MHz.

1. Enable the PWM clock by writing a value of 0x0010.0000 to the **RCGC0** register in the System Control module.
2. Enable the clock to the appropriate GPIO module via the **RCGC2** register in the System Control module.
3. In the GPIO module, enable the appropriate pins for their alternate function using the **GPIOAFSEL** register.
4. Configure the **Run-Mode Clock Configuration (RCC)** register in the System Control module to use the PWM divide (`USEPWMDIV`) and set the divider (`PWMDIV`) to divide by 2 (000).
5. Configure the PWM generator for countdown mode with immediate updates to the parameters.
 - Write the **PWM0CTL** register with a value of 0x0000.0000.
 - Write the **PWM0GENA** register with a value of 0x0000.008C.
 - Write the **PWM0GENB** register with a value of 0x0000.080C.
6. Set the period. For a 25-KHz frequency, the period = 1/25,000, or 40 microseconds. The PWM clock source is 10 MHz; the system clock divided by 2. This translates to 400 clock ticks per period. Use this value to set the **PWM0LOAD** register. In Count-Down mode, set the `Load` field in the **PWM0LOAD** register to the requested period minus one.

- Write the **PWM0LOAD** register with a value of 0x0000.018F.
- 7. Set the pulse width of the `PWM0` pin for a 25% duty cycle.
 - Write the **PWM0CMPA** register with a value of 0x0000.012B.
- 8. Set the pulse width of the `PWM1` pin for a 75% duty cycle.
 - Write the **PWM0CMPB** register with a value of 0x0000.0063.
- 9. Start the timers in PWM generator 0.
 - Write the **PWM0CTL** register with a value of 0x0000.0001.
- 10. Enable PWM outputs.
 - Write the **PWMENABLE** register with a value of 0x0000.0003.

17.4 Register Map

Table 17-1 on page 450 lists the PWM registers. The offset listed is a hexadecimal increment to the register's address, relative to the PWM base address of 0x4002.8000.

Table 17-1. PWM Register Map

Offset	Name	Type	Reset	Description	See page
0x000	PWMCTL	R/W	0x0000.0000	PWM Master Control	452
0x004	PWMSYNC	R/W	0x0000.0000	PWM Time Base Sync	453
0x008	PWMENABLE	R/W	0x0000.0000	PWM Output Enable	454
0x00C	PWMINVERT	R/W	0x0000.0000	PWM Output Inversion	455
0x010	PWMFAULT	R/W	0x0000.0000	PWM Output Fault	456
0x014	PWMINTEN	R/W	0x0000.0000	PWM Interrupt Enable	457
0x018	PWMRIS	RO	0x0000.0000	PWM Raw Interrupt Status	458
0x01C	PWMISC	R/W1C	0x0000.0000	PWM Interrupt Status and Clear	459
0x020	PWMSTATUS	RO	0x0000.0000	PWM Status	460
0x040	PWM0CTL	R/W	0x0000.0000	PWM0 Control	461
0x044	PWM0INTEN	R/W	0x0000.0000	PWM0 Interrupt and Trigger Enable	463
0x048	PWM0RIS	RO	0x0000.0000	PWM0 Raw Interrupt Status	465
0x04C	PWM0ISC	R/W1C	0x0000.0000	PWM0 Interrupt Status and Clear	466
0x050	PWM0LOAD	R/W	0x0000.0000	PWM0 Load	467
0x054	PWM0COUNT	RO	0x0000.0000	PWM0 Counter	468
0x058	PWM0CMPA	R/W	0x0000.0000	PWM0 Compare A	469
0x05C	PWM0CMPB	R/W	0x0000.0000	PWM0 Compare B	470
0x060	PWM0GENA	R/W	0x0000.0000	PWM0 Generator A Control	471

Offset	Name	Type	Reset	Description	See page
0x064	PWM0GENB	R/W	0x0000.0000	PWM0 Generator B Control	474
0x068	PWM0DBCTL	R/W	0x0000.0000	PWM0 Dead-Band Control	477
0x06C	PWM0DBRISE	R/W	0x0000.0000	PWM0 Dead-Band Rising-Edge Delay	478
0x070	PWM0DBFALL	R/W	0x0000.0000	PWM0 Dead-Band Falling-Edge-Delay	479

17.5 Register Descriptions

The remainder of this section lists and describes the PWM registers, in numerical order by address offset.

Register 1: PWM Master Control (PWMCTL), offset 0x000

This register provides master control over the PWM generation block.

PWM Master Control (PWMCTL)

Base 0x4002.8000
 Offset 0x000
 Type R/W, reset 0x0000.0000

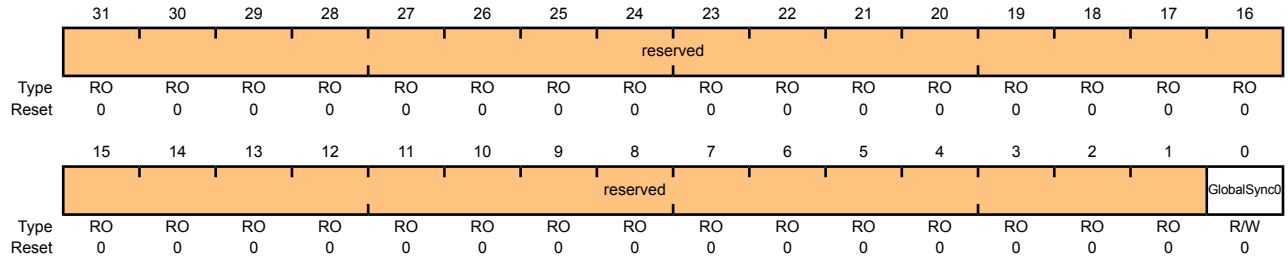

Bit/Field	Name	Type	Reset	Description
31:1	reserved	RO	0x00	Software should not rely on the value of a reserved bit. To provide compatibility with future products, the value of a reserved bit should be preserved across a read-modify-write operation.
0	GlobalSync0	R/W	0	Update PWM Generator 0 Setting this bit causes any queued update to a load or comparator register in PWM generator 0 to be applied the next time the corresponding counter becomes zero. This bit automatically clears when the updates have completed; it cannot be cleared by software.

Register 2: PWM Time Base Sync (PWMSYNC), offset 0x004

This register provides a method to perform synchronization of the counters in the PWM generation blocks. Writing a bit in this register to 1 causes the specified counter to reset back to 0; writing multiple bits resets multiple counters simultaneously. The bits auto-clear after the reset has occurred; reading them back as zero indicates that the synchronization has completed.

PWM Time Base Sync (PWMSYNC)

Base 0x4002.8000
Offset 0x004
Type R/W, reset 0x0000.0000

	31	30	29	28	27	26	25	24	23	22	21	20	19	18	17	16
	reserved															
Type	RO	RO	RO	RO	RO	RO	RO	RO	RO	RO	RO	RO	RO	RO	RO	RO
Reset	0	0	0	0	0	0	0	0	0	0	0	0	0	0	0	0
	15	14	13	12	11	10	9	8	7	6	5	4	3	2	1	0
	reserved															Sync0
Type	RO	RO	RO	RO	RO	RO	RO	RO	RO	RO	RO	RO	RO	RO	RO	R/W
Reset	0	0	0	0	0	0	0	0	0	0	0	0	0	0	0	0

Bit/Field	Name	Type	Reset	Description
31:1	reserved	RO	0x00	Software should not rely on the value of a reserved bit. To provide compatibility with future products, the value of a reserved bit should be preserved across a read-modify-write operation.
0	Sync0	R/W	0	Reset Generator 0 Counter Performs a reset of the PWM generator 0 counter.

Register 3: PWM Output Enable (PWMENABLE), offset 0x008

This register provides a master control of which generated PWM signals are output to device pins. By disabling a PWM output, the generation process can continue (for example, when the time bases are synchronized) without driving PWM signals to the pins. When bits in this register are set, the corresponding PWM signal is passed through to the output stage, which is controlled by the **PWMINVERT** register. When bits are not set, the PWM signal is replaced by a zero value which is also passed to the output stage.

PWM Output Enable (PWMENABLE)

Base 0x4002.8000
 Offset 0x008
 Type R/W, reset 0x0000.0000

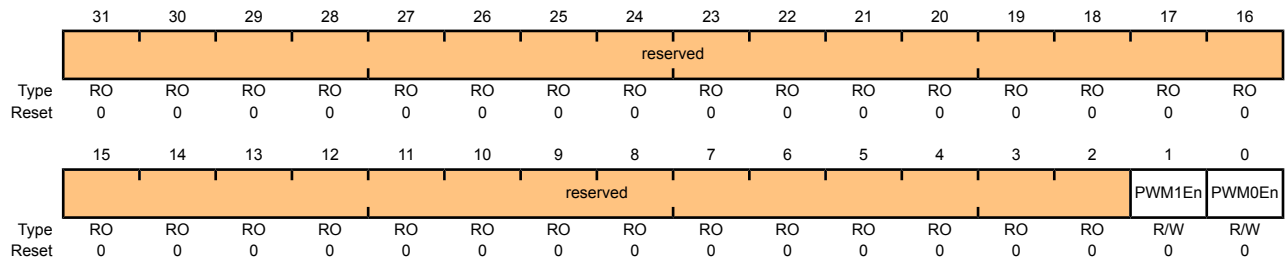

Bit/Field	Name	Type	Reset	Description
31:2	reserved	RO	0x00	Software should not rely on the value of a reserved bit. To provide compatibility with future products, the value of a reserved bit should be preserved across a read-modify-write operation.
1	PWM1En	R/W	0	PWM1 Output Enable When set, allows the generated PWM1 signal to be passed to the device pin.
0	PWM0En	R/W	0	PWM0 Output Enable When set, allows the generated PWM0 signal to be passed to the device pin.

Register 4: PWM Output Inversion (PWMINVERT), offset 0x00C

This register provides a master control of the polarity of the PWM signals on the device pins. The PWM signals generated by the PWM generator are active High; they can optionally be made active Low via this register. Disabled PWM channels are also passed through the output inverter (if so configured) so that inactive channels maintain the correct polarity.

PWM Output Inversion (PWMINVERT)

Base 0x4002.8000
Offset 0x00C
Type R/W, reset 0x0000.0000

	31	30	29	28	27	26	25	24	23	22	21	20	19	18	17	16	
	reserved																
Type	RO	RO	RO	RO	RO	RO	RO	RO	RO	RO	RO	RO	RO	RO	RO	RO	
Reset	0	0	0	0	0	0	0	0	0	0	0	0	0	0	0	0	
	15	14	13	12	11	10	9	8	7	6	5	4	3	2	1	0	
	reserved														PWM1Inv	PWM0Inv	
Type	RO	RO	RO	RO	RO	RO	RO	RO	RO	RO	RO	RO	RO	RO	RO	R/W	R/W
Reset	0	0	0	0	0	0	0	0	0	0	0	0	0	0	0	0	0

Bit/Field	Name	Type	Reset	Description
31:2	reserved	RO	0x00	Software should not rely on the value of a reserved bit. To provide compatibility with future products, the value of a reserved bit should be preserved across a read-modify-write operation.
1	PWM1Inv	R/W	0	Invert PWM1 Signal When set, the generated PWM1 signal is inverted.
0	PWM0Inv	R/W	0	Invert PWM0 Signal When set, the generated PWM0 signal is inverted.

Register 5: PWM Output Fault (PWMFAULT), offset 0x010

This register controls the behavior of the PWM outputs in the presence of fault conditions. Both the fault input and debug events are considered fault conditions. On a fault condition, each PWM signal can either be passed through unmodified or driven Low. For outputs that are configured for pass-through, the debug event handling on the corresponding PWM generator also determines if the PWM signal continues to be generated.

Fault condition control happens before the output inverter, so PWM signals driven Low on fault are inverted if the channel is configured for inversion (therefore, the pin is driven High on a fault condition).

PWM Output Fault (PWMFAULT)

Base 0x4002.8000
 Offset 0x010
 Type R/W, reset 0x0000.0000

	31	30	29	28	27	26	25	24	23	22	21	20	19	18	17	16	
	reserved																
Type	RO	RO	RO	RO	RO	RO	RO	RO	RO	RO	RO	RO	RO	RO	RO	RO	
Reset	0	0	0	0	0	0	0	0	0	0	0	0	0	0	0	0	
	15	14	13	12	11	10	9	8	7	6	5	4	3	2	1	0	
	reserved															Fault1	Fault0
Type	RO	RO	RO	RO	RO	RO	RO	RO	RO	RO	RO	RO	RO	RO	RO	R/W	R/W
Reset	0	0	0	0	0	0	0	0	0	0	0	0	0	0	0	0	0

Bit/Field	Name	Type	Reset	Description
31:2	reserved	RO	0x00	Software should not rely on the value of a reserved bit. To provide compatibility with future products, the value of a reserved bit should be preserved across a read-modify-write operation.
1	Fault1	R/W	0	PWM1 Driven Low on Fault When set, the PWM1 output signal is driven Low on a fault condition.
0	Fault0	R/W	0	PWM0 Driven Low on Fault When set, the PWM0 output signal is driven Low on a fault condition.

Register 6: PWM Interrupt Enable (PWMINTEN), offset 0x014

This register controls the global interrupt generation capabilities of the PWM module. The events that can cause an interrupt are the fault input and the individual interrupts from the PWM generator.

PWM Interrupt Enable (PWMINTEN)

Base 0x4002.8000

Offset 0x014

Type R/W, reset 0x0000.0000

	31	30	29	28	27	26	25	24	23	22	21	20	19	18	17	16
	reserved															IntFault
Type	RO	RO	RO	RO	RO	RO	RO	RO	RO	RO	RO	RO	RO	RO	RO	RO
Reset	0	0	0	0	0	0	0	0	0	0	0	0	0	0	0	0
	15	14	13	12	11	10	9	8	7	6	5	4	3	2	1	0
	reserved															IntPWM0
Type	RO	RO	RO	RO	RO	RO	RO	RO	RO	RO	RO	RO	RO	RO	RO	RO
Reset	0	0	0	0	0	0	0	0	0	0	0	0	0	0	0	0

Bit/Field	Name	Type	Reset	Description
31:17	reserved	RO	0x00	Software should not rely on the value of a reserved bit. To provide compatibility with future products, the value of a reserved bit should be preserved across a read-modify-write operation.
16	IntFault	R/W	0	Fault Interrupt Enable When 1, an interrupt occurs when the fault input is asserted.
15:1	reserved	RO	0x00	Software should not rely on the value of a reserved bit. To provide compatibility with future products, the value of a reserved bit should be preserved across a read-modify-write operation.
0	IntPWM0	R/W	0	PWM0 Interrupt Enable When 1, an interrupt occurs when the PWM generator 0 block asserts an interrupt.

Register 7: PWM Raw Interrupt Status (PWMRIS), offset 0x018

This register provides the current set of interrupt sources that are asserted, regardless of whether they cause an interrupt to be asserted to the controller. The fault interrupt is latched on detection; it must be cleared through the **PWM Interrupt Status and Clear (PWMISC)** register (see page 459). The PWM generator interrupts simply reflect the status of the PWM generator; they are cleared via the interrupt status register in the PWM generator block. Bits set to 1 indicate the events that are active; a zero bit indicates that the event in question is not active.

PWM Raw Interrupt Status (PWMRIS)

Base 0x4002.8000
 Offset 0x018
 Type RO, reset 0x0000.0000

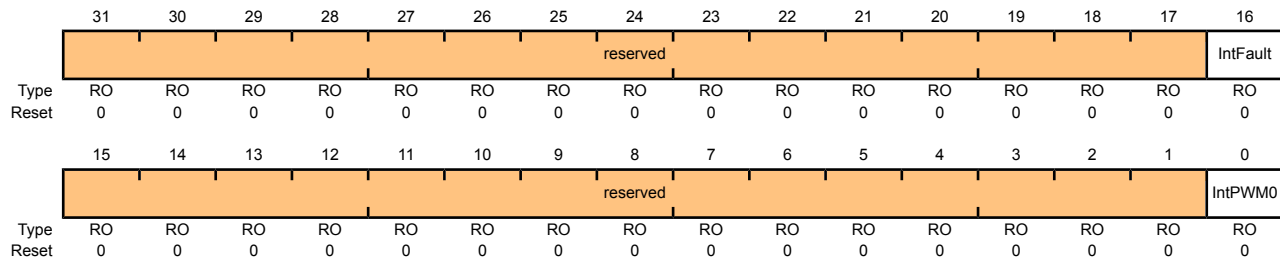

Bit/Field	Name	Type	Reset	Description
31:17	reserved	RO	0x00	Software should not rely on the value of a reserved bit. To provide compatibility with future products, the value of a reserved bit should be preserved across a read-modify-write operation.
16	IntFault	RO	0	Fault Interrupt Asserted Indicates that the fault input has been asserted.
15:1	reserved	RO	0x00	Software should not rely on the value of a reserved bit. To provide compatibility with future products, the value of a reserved bit should be preserved across a read-modify-write operation.
0	IntPWM0	RO	0	PWM0 Interrupt Asserted Indicates that the PWM generator 0 block is asserting its interrupt.

Register 8: PWM Interrupt Status and Clear (PWMISC), offset 0x01C

This register provides a summary of the interrupt status of the PWM generator block. A bit set to 1 indicates that the generator block is asserting an interrupt. The individual interrupt status registers must be consulted to determine the reason for the interrupt, and used to clear the interrupt. For the fault interrupt, a write of 1 to that bit position clears the latched interrupt status.

PWM Interrupt Status and Clear (PWMISC)

Base 0x4002.8000

Offset 0x01C

Type R/W1C, reset 0x0000.0000

	31	30	29	28	27	26	25	24	23	22	21	20	19	18	17	16
	reserved															IntFault
Type	RO	RO	RO	RO	RO	RO	RO	RO	RO	RO	RO	RO	RO	RO	RO	R/W1C
Reset	0	0	0	0	0	0	0	0	0	0	0	0	0	0	0	0
	15	14	13	12	11	10	9	8	7	6	5	4	3	2	1	0
	reserved															IntPWM0
Type	RO	RO	RO	RO	RO	RO	RO	RO	RO	RO	RO	RO	RO	RO	RO	RO
Reset	0	0	0	0	0	0	0	0	0	0	0	0	0	0	0	0

Bit/Field	Name	Type	Reset	Description
31:17	reserved	RO	0x00	Software should not rely on the value of a reserved bit. To provide compatibility with future products, the value of a reserved bit should be preserved across a read-modify-write operation.
16	IntFault	R/W1C	0	Fault Interrupt Asserted Indicates if the fault input is asserting an interrupt.
15:1	reserved	RO	0x00	Software should not rely on the value of a reserved bit. To provide compatibility with future products, the value of a reserved bit should be preserved across a read-modify-write operation.
0	IntPWM0	RO	0	PWM0 Interrupt Status Indicates if the PWM generator 0 block is asserting an interrupt.

Register 9: PWM Status (PWMSTATUS), offset 0x020

This register provides the status of the Fault input signal.

PWM Status (PWMSTATUS)

Base 0x4002.8000
 Offset 0x020
 Type RO, reset 0x0000.0000

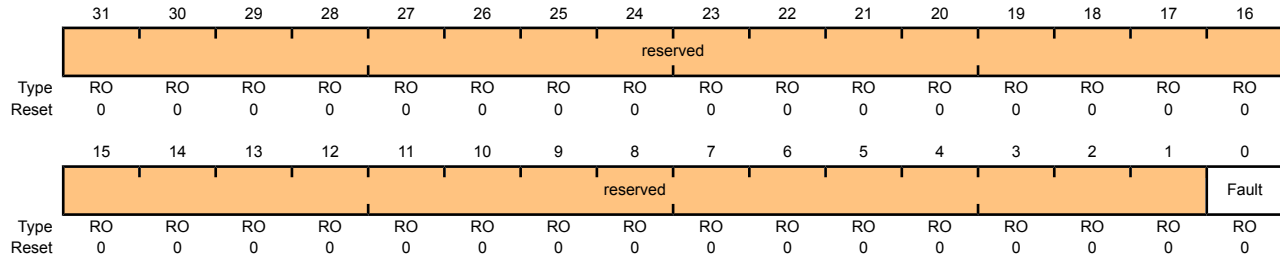

Bit/Field	Name	Type	Reset	Description
31:1	reserved	RO	0x00	Software should not rely on the value of a reserved bit. To provide compatibility with future products, the value of a reserved bit should be preserved across a read-modify-write operation.
0	Fault	RO	0	Fault Interrupt Status When set to 1, indicates the fault input is asserted.

Register 10: PWM Control (PWM0CTL), offset 0x040

This register configures the PWM signal generation block. The Register Update mode, Debug mode, Counting mode, and Block Enable mode are all controlled via this register. The block produces the PWM signals, which can be either two independent PWM signals (from the same counter), or a paired set of PWM signals with dead-band delays added.

These registers configure the PWM signal generation blocks (PWM0CTL controls the PWM generator 0 block, and so on). The Register Update mode, Debug mode, Counting mode, and Block Enable mode are all controlled via these registers. The blocks produce the PWM signals, which can be either two independent PWM signals (from the same counter), or a paired set of PWM signals with dead-band delays added.

The PWM0 block produces the PWM0 and PWM1 outputs.

PWM0 Control (PWM0CTL)

Base 0x4002.8000
 Offset 0x040
 Type R/W, reset 0x0000.0000

	31	30	29	28	27	26	25	24	23	22	21	20	19	18	17	16	
	reserved																
Type	RO	RO	RO	RO	RO	RO	RO	RO	RO	RO	RO	RO	RO	RO	RO	RO	
Reset	0	0	0	0	0	0	0	0	0	0	0	0	0	0	0	0	
	15	14	13	12	11	10	9	8	7	6	5	4	3	2	1	0	
	reserved											CmpBUpd	CmpAUpd	LoadUpd	Debug	Mode	Enable
Type	RO	RO	RO	RO	RO	RO	RO	RO	RO	RO	RO	R/W	R/W	R/W	R/W	R/W	
Reset	0	0	0	0	0	0	0	0	0	0	0	0	0	0	0	0	

Bit/Field	Name	Type	Reset	Description
31:6	reserved	RO	0x00	Software should not rely on the value of a reserved bit. To provide compatibility with future products, the value of a reserved bit should be preserved across a read-modify-write operation.
5	CmpBUpd	R/W	0	Comparator B Update Mode Same as CmpAUpd but for the comparator B register.
4	CmpAUpd	R/W	0	Comparator A Update Mode The Update mode for the comparator A register. If 0, updates to the register are reflected to the comparator the next time the counter is 0. If 1, updates to the register are delayed until the next time the counter is 0 after a synchronous update has been requested through the PWM Master Control (PWMCTL) register (see page 452).
3	LoadUpd	R/W	0	Load Register Update Mode The Update mode for the load register. If 0, updates to the register are reflected to the counter the next time the counter is 0. If 1, updates to the register are delayed until the next time the counter is 0 after a synchronous update has been requested through the PWM Master Control (PWMCTL) register.
2	Debug	R/W	0	Debug Mode The behavior of the counter in Debug mode. If 0, the counter stops running when it next reaches 0, and continues running again when no longer in Debug mode. If 1, the counter always runs.

Bit/Field	Name	Type	Reset	Description
1	Mode	R/W	0	Counter Mode The mode for the counter. If 0, the counter counts down from the load value to 0 and then wraps back to the load value (Count-Down mode). If 1, the counter counts up from 0 to the load value, back down to 0, and then repeats (Count-Up/Down mode).
0	Enable	R/W	0	PWM Block Enable Master enable for the PWM generation block. If 0, the entire block is disabled and not clocked. If 1, the block is enabled and produces PWM signals.

Register 11: PWM0 Interrupt and Trigger Enable (PWM0INTEN), offset 0x044

This register controls the interrupt and ADC trigger generation capabilities of the PWM generator. The events that can cause an interrupt or an ADC trigger are:

- The counter being equal to the load register
- The counter being equal to zero
- The counter being equal to the comparator A register while counting up
- The counter being equal to the comparator A register while counting down
- The counter being equal to the comparator B register while counting up
- The counter being equal to the comparator B register while counting down

Any combination of these events can generate either an interrupt or an ADC trigger, though no determination can be made as to the actual event that caused an ADC trigger if more than one is specified.

PWM0 Interrupt and Trigger Enable (PWM0INTEN)

Base 0x4002.8000
Offset 0x044
Type R/W, reset 0x0000.0000

	31	30	29	28	27	26	25	24	23	22	21	20	19	18	17	16
	reserved															
Type	RO	RO	RO	RO	RO	RO	RO	RO	RO	RO	RO	RO	RO	RO	RO	RO
Reset	0	0	0	0	0	0	0	0	0	0	0	0	0	0	0	0
	15	14	13	12	11	10	9	8	7	6	5	4	3	2	1	0
	reserved		TrCmpBD	TrCmpBU	TrCmpAD	TrCmpAU	TrCntLoad	TrCntZero	reserved		IntCmpBD	IntCmpBU	IntCmpAD	IntCmpAU	IntCntLoad	IntCntZero
Type	RO	RO	R/W	R/W	R/W	R/W	R/W	R/W	RO	RO	R/W	R/W	R/W	R/W	R/W	R/W
Reset	0	0	0	0	0	0	0	0	0	0	0	0	0	0	0	0

Bit/Field	Name	Type	Reset	Description
31:14	reserved	RO	0x00	Software should not rely on the value of a reserved bit. To provide compatibility with future products, the value of a reserved bit should be preserved across a read-modify-write operation.
13	TrCmpBD	R/W	0	Trigger for Counter=Comparator B Down When 1, a trigger pulse is output when the counter matches the comparator B value and the counter is counting down.
12	TrCmpBU	R/W	0	Trigger for Counter=Comparator B Up When 1, a trigger pulse is output when the counter matches the comparator B value and the counter is counting up.
11	TrCmpAD	R/W	0	Trigger for Counter=Comparator A Down When 1, a trigger pulse is output when the counter matches the comparator A value and the counter is counting down.
10	TrCmpAU	R/W	0	Trigger for Counter=Comparator A Up When 1, a trigger pulse is output when the counter matches the comparator A value and the counter is counting up.

Bit/Field	Name	Type	Reset	Description
9	TrCntLoad	R/W	0	Trigger for Counter=Load When 1, a trigger pulse is output when the counter matches the PWMnLOAD register.
8	TrCntZero	R/W	0	Trigger for Counter=0 When 1, a trigger pulse is output when the counter is 0.
7:6	reserved	RO	0x0	Software should not rely on the value of a reserved bit. To provide compatibility with future products, the value of a reserved bit should be preserved across a read-modify-write operation.
5	IntCmpBD	R/W	0	Interrupt for Counter=Comparator B Down When 1, an interrupt occurs when the counter matches the comparator B value and the counter is counting down.
4	IntCmpBU	R/W	0	Interrupt for Counter=Comparator B Up When 1, an interrupt occurs when the counter matches the comparator B value and the counter is counting up.
3	IntCmpAD	R/W	0	Interrupt for Counter=Comparator A Down When 1, an interrupt occurs when the counter matches the comparator A value and the counter is counting down.
2	IntCmpAU	R/W	0	Interrupt for Counter=Comparator A Up When 1, an interrupt occurs when the counter matches the comparator A value and the counter is counting up.
1	IntCntLoad	R/W	0	Interrupt for Counter=Load When 1, an interrupt occurs when the counter matches the PWMnLOAD register.
0	IntCntZero	R/W	0	Interrupt for Counter=0 When 1, an interrupt occurs when the counter is 0.

Register 12: PWM Raw Interrupt Status (PWM0RIS), offset 0x048

This register provides the current set of interrupt sources that are asserted, regardless of whether they cause an interrupt to be asserted to the controller. Bits set to 1 indicate the latched events that have occurred; a 0 bit indicates that the event in question has not occurred.

PWM0 Raw Interrupt Status (PWM0RIS)

Base 0x4002.8000

Offset 0x048

Type RO, reset 0x0000.0000

	31	30	29	28	27	26	25	24	23	22	21	20	19	18	17	16	
	reserved																
Type	RO	RO	RO	RO	RO	RO	RO	RO	RO	RO	RO	RO	RO	RO	RO	RO	
Reset	0	0	0	0	0	0	0	0	0	0	0	0	0	0	0	0	
	15	14	13	12	11	10	9	8	7	6	5	4	3	2	1	0	
	reserved											IntCmpBD	IntCmpBU	IntCmpAD	IntCmpAU	IntCntLoad	IntCntZero
Type	RO	RO	RO	RO	RO	RO	RO	RO	RO	RO	RO	RO	RO	RO	RO	RO	
Reset	0	0	0	0	0	0	0	0	0	0	0	0	0	0	0	0	

Bit/Field	Name	Type	Reset	Description
31:6	reserved	RO	0x00	Software should not rely on the value of a reserved bit. To provide compatibility with future products, the value of a reserved bit should be preserved across a read-modify-write operation.
5	IntCmpBD	RO	0	Comparator B Down Interrupt Status Indicates that the counter has matched the comparator B value while counting down.
4	IntCmpBU	RO	0	Comparator B Up Interrupt Status Indicates that the counter has matched the comparator B value while counting up.
3	IntCmpAD	RO	0	Comparator A Down Interrupt Status Indicates that the counter has matched the comparator A value while counting down.
2	IntCmpAU	RO	0	Comparator A Up Interrupt Status Indicates that the counter has matched the comparator A value while counting up.
1	IntCntLoad	RO	0	Counter=Load Interrupt Status Indicates that the counter has matched the PWMnLOAD register.
0	IntCntZero	RO	0	Counter=0 Interrupt Status Indicates that the counter has matched 0.

Register 13: PWM0 Interrupt Status and Clear (PWM0ISC), offset 0x04C

This register provides the current set of interrupt sources that are asserted to the controller. Bits set to 1 indicate the latched events that have occurred; a 0 bit indicates that the event in question has not occurred. These are R/W1C registers; writing a 1 to a bit position clears the corresponding interrupt reason.

PWM0 Interrupt Status and Clear (PWM0ISC)

Base 0x4002.8000
 Offset 0x04C
 Type R/W1C, reset 0x0000.0000

	31	30	29	28	27	26	25	24	23	22	21	20	19	18	17	16	
	reserved																
Type	RO	RO	RO	RO	RO	RO	RO	RO	RO	RO	RO	RO	RO	RO	RO	RO	
Reset	0	0	0	0	0	0	0	0	0	0	0	0	0	0	0	0	
	15	14	13	12	11	10	9	8	7	6	5	4	3	2	1	0	
	reserved											IntCmpBD	IntCmpBU	IntCmpAD	IntCmpAU	IntCntLoad	IntCntZero
Type	RO	RO	RO	RO	RO	RO	RO	RO	RO	RO	R/W1C	R/W1C	R/W1C	R/W1C	R/W1C	R/W1C	
Reset	0	0	0	0	0	0	0	0	0	0	0	0	0	0	0	0	

Bit/Field	Name	Type	Reset	Description
31:6	reserved	RO	0x00	Software should not rely on the value of a reserved bit. To provide compatibility with future products, the value of a reserved bit should be preserved across a read-modify-write operation.
5	IntCmpBD	R/W1C	0	Comparator B Down Interrupt Indicates that the counter has matched the comparator B value while counting down.
4	IntCmpBU	R/W1C	0	Comparator B Up Interrupt Indicates that the counter has matched the comparator B value while counting up.
3	IntCmpAD	R/W1C	0	Comparator A Down Interrupt Indicates that the counter has matched the comparator A value while counting down.
2	IntCmpAU	R/W1C	0	Comparator A Up Interrupt Indicates that the counter has matched the comparator A value while counting up.
1	IntCntLoad	R/W1C	0	Counter=Load Interrupt Indicates that the counter has matched the PWMnLOAD register.
0	IntCntZero	R/W1C	0	Counter=0 Interrupt Indicates that the counter has matched 0.

Register 14: PWM0 Load (PWM0LOAD), offset 0x050

This register contains the load value for the PWM counter. Based on the counter mode, either this value is loaded into the counter after it reaches zero, or it is the limit of up-counting after which the counter decrements back to zero. If the Load Value Update mode is immediate, this value is used the next time the counter reaches zero; if the mode is synchronous, it is used the next time the counter reaches zero after a synchronous update has been requested through the **PWM Master Control (PWMCTL)** register (see page 452). If this register is re-written before the actual update occurs, the previous value is never used and is lost.

PWM0 Load (PWM0LOAD)

Base 0x4002.8000

Offset 0x050

Type R/W, reset 0x0000.0000

	31	30	29	28	27	26	25	24	23	22	21	20	19	18	17	16
	reserved															
Type	RO	RO	RO	RO	RO	RO	RO	RO	RO	RO	RO	RO	RO	RO	RO	RO
Reset	0	0	0	0	0	0	0	0	0	0	0	0	0	0	0	0
	15	14	13	12	11	10	9	8	7	6	5	4	3	2	1	0
	Load															
Type	R/W	R/W	R/W	R/W	R/W	R/W	R/W	R/W	R/W	R/W	R/W	R/W	R/W	R/W	R/W	R/W
Reset	0	0	0	0	0	0	0	0	0	0	0	0	0	0	0	0

Bit/Field	Name	Type	Reset	Description
31:16	reserved	RO	0x00	Software should not rely on the value of a reserved bit. To provide compatibility with future products, the value of a reserved bit should be preserved across a read-modify-write operation.
15:0	Load	R/W	0	Counter Load Value The counter load value.

Register 15: PWM Counter (PWM0COUNT), offset 0x054

This register contains the current value of the PWM counter. When this value matches the load register, a pulse is output; this can drive the generation of a PWM signal (via the **PWMnGENA/PWMnGENB** registers, see page 471 and page 474) or drive an interrupt or ADC trigger (via the **PWMnINTEN** register, see page 463). A pulse with the same capabilities is generated when this value is zero.

PWM0 Counter (PWM0COUNT)

Base 0x4002.8000
 Offset 0x054
 Type RO, reset 0x0000.0000

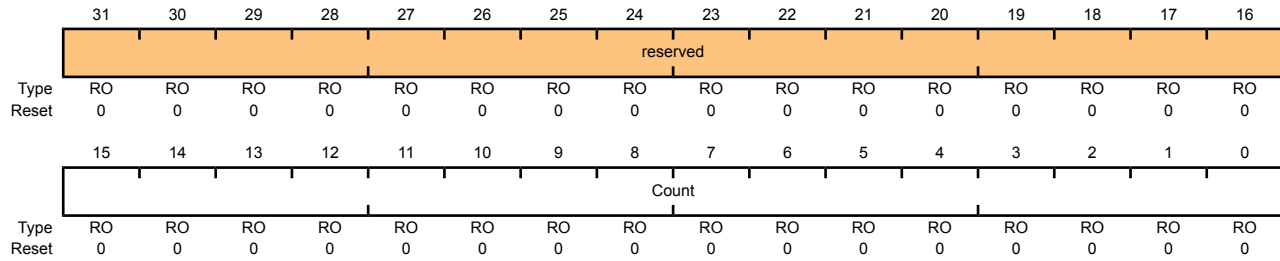

Bit/Field	Name	Type	Reset	Description
31:16	reserved	RO	0x00	Software should not rely on the value of a reserved bit. To provide compatibility with future products, the value of a reserved bit should be preserved across a read-modify-write operation.
15:0	Count	RO	0x00	Counter Value The current value of the counter.

Register 16: PWM Compare A (PWM0CMPA), offset 0x058

This register contains a value to be compared against the counter . When this value matches the counter, a pulse is output; this can drive the generation of a PWM signal (via the **PWMnGENA/PWMnGENB** registers) or drive an interrupt or ADC trigger (via the **PWMnINTEN** register). If the value of this register is greater than the **PWMnLOAD** register (see page 467), then no pulse is ever output.

If the comparator A update mode is immediate (based on the **CompAUpd** bit in the **PWMnCTL** register), then this 16-bit **CompA** value is used the next time the counter reaches zero. If the update mode is synchronous, it is used the next time the counter reaches zero after a synchronous update has been requested through the **PWM Master Control (PWMCTL)** register (see page 452). If this register is rewritten before the actual update occurs, the previous value is never used and is lost.

PWM0 Compare A (PWM0CMPA)

Base 0x4002.8000
 Offset 0x058
 Type R/W, reset 0x0000.0000

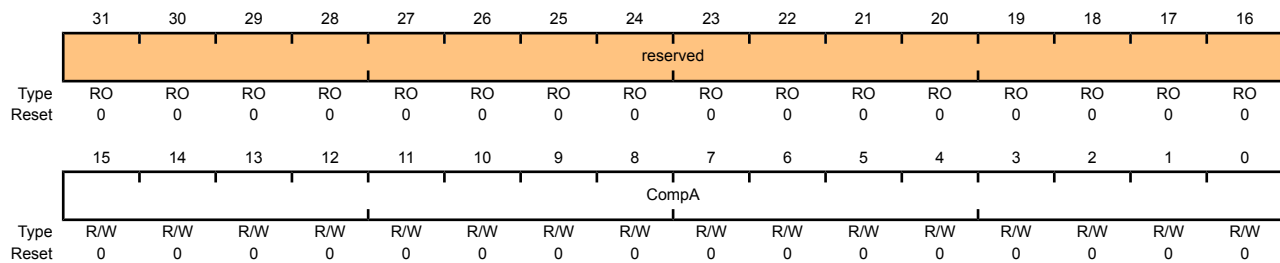

Bit/Field	Name	Type	Reset	Description
31:16	reserved	RO	0x00	Software should not rely on the value of a reserved bit. To provide compatibility with future products, the value of a reserved bit should be preserved across a read-modify-write operation.
15:0	CompA	R/W	0x00	Comparator A Value The value to be compared against the counter.

Register 17: PWM0 Compare B (PWM0CMPB), offset 0x05C

This register contains a value to be compared against the counter. When this value matches the counter, a pulse is output; this can drive the generation of a PWM signal (via the **PWMnGENA/PWMnGENB** registers) or drive an interrupt or ADC trigger (via the **PWMnINTEN** register). If the value of this register is greater than the **PWMnLOAD** register, then no pulse is ever output.

IF the comparator B update mode is immediate (based on the **CompBUpd** bit in the **PWMnCTL** register), then this 16-bit **CompB** value is used the next time the counter reaches zero. If the update mode is synchronous, it is used the next time the counter reaches zero after a synchronous update has been requested through the **PWM Master Control (PWMCTL)** register (see page 452). If this register is rewritten before the actual update occurs, the previous value is never used and is lost.

PWM0 Compare B (PWM0CMPB)

Base 0x4002.8000
 Offset 0x05C
 Type R/W, reset 0x0000.0000

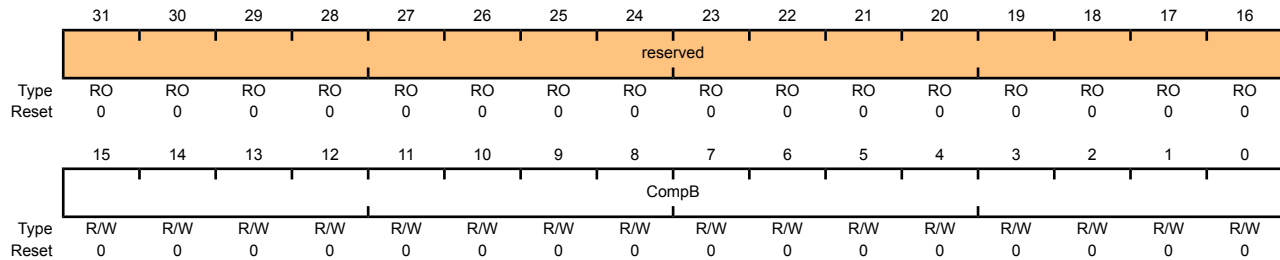

Bit/Field	Name	Type	Reset	Description
31:16	reserved	RO	0x00	Software should not rely on the value of a reserved bit. To provide compatibility with future products, the value of a reserved bit should be preserved across a read-modify-write operation.
15:0	CompB	R/W	0x00	Comparator B Value The value to be compared against the counter.

Register 18: PWM0 Generator A Control (PWM0GENA), offset 0x060

This register controls the generation of the PWM_{nA} signal based on the load and zero output pulses from the counter, as well as the compare A and compare B pulses from the comparators. When the counter is running in Count-Down mode, only four of these events occur; when running in Count-Up/Down mode, all six occur. These events provide great flexibility in the positioning and duty cycle of the PWM signal that is produced.

The **PWM0GENA** register controls generation of the PWM_{0A} signal.

If a zero or load event coincides with a compare A or compare B event, the zero or load action is taken and the compare A or compare B action is ignored. If a compare A event coincides with a compare B event, the compare A action is taken and the compare B action is ignored.

PWM0 Generator A Control (PWM0GENA)

Base 0x4002.8000

Offset 0x060

Type R/W, reset 0x0000.0000

	31	30	29	28	27	26	25	24	23	22	21	20	19	18	17	16
	reserved															
Type	RO	RO	RO	RO	RO	RO	RO	RO	RO	RO	RO	RO	RO	RO	RO	RO
Reset	0	0	0	0	0	0	0	0	0	0	0	0	0	0	0	0
	15	14	13	12	11	10	9	8	7	6	5	4	3	2	1	0
	reserved				ActCmpBD	ActCmpBU		ActCmpAD		ActCmpAU		ActLoad		ActZero		
Type	RO	RO	RO	RO	R/W	R/W	R/W	R/W	R/W	R/W	R/W	R/W	R/W	R/W	R/W	R/W
Reset	0	0	0	0	0	0	0	0	0	0	0	0	0	0	0	0

Bit/Field	Name	Type	Reset	Description
31:12	reserved	RO	0x00	Software should not rely on the value of a reserved bit. To provide compatibility with future products, the value of a reserved bit should be preserved across a read-modify-write operation.

11:10	ActCmpBD	R/W	0x0	Action for Comparator B Down The action to be taken when the counter matches comparator B while counting down.
-------	----------	-----	-----	---

The table below defines the effect of the event on the output signal.

Value	Description
0x0	Do nothing.
0x1	Invert the output signal.
0x2	Set the output signal to 0.
0x3	Set the output signal to 1.

Bit/Field	Name	Type	Reset	Description										
9:8	ActCmpBU	R/W	0x0	<p>Action for Comparator B Up</p> <p>The action to be taken when the counter matches comparator B while counting up. Occurs only when the <code>Mode</code> bit in the PWMnCTL register (see page 461) is set to 1.</p> <p>The table below defines the effect of the event on the output signal.</p> <table border="1"> <thead> <tr> <th>Value</th> <th>Description</th> </tr> </thead> <tbody> <tr> <td>0x0</td> <td>Do nothing.</td> </tr> <tr> <td>0x1</td> <td>Invert the output signal.</td> </tr> <tr> <td>0x2</td> <td>Set the output signal to 0.</td> </tr> <tr> <td>0x3</td> <td>Set the output signal to 1.</td> </tr> </tbody> </table>	Value	Description	0x0	Do nothing.	0x1	Invert the output signal.	0x2	Set the output signal to 0.	0x3	Set the output signal to 1.
Value	Description													
0x0	Do nothing.													
0x1	Invert the output signal.													
0x2	Set the output signal to 0.													
0x3	Set the output signal to 1.													
7:6	ActCmpAD	R/W	0x0	<p>Action for Comparator A Down</p> <p>The action to be taken when the counter matches comparator A while counting down.</p> <p>The table below defines the effect of the event on the output signal.</p> <table border="1"> <thead> <tr> <th>Value</th> <th>Description</th> </tr> </thead> <tbody> <tr> <td>0x0</td> <td>Do nothing.</td> </tr> <tr> <td>0x1</td> <td>Invert the output signal.</td> </tr> <tr> <td>0x2</td> <td>Set the output signal to 0.</td> </tr> <tr> <td>0x3</td> <td>Set the output signal to 1.</td> </tr> </tbody> </table>	Value	Description	0x0	Do nothing.	0x1	Invert the output signal.	0x2	Set the output signal to 0.	0x3	Set the output signal to 1.
Value	Description													
0x0	Do nothing.													
0x1	Invert the output signal.													
0x2	Set the output signal to 0.													
0x3	Set the output signal to 1.													
5:4	ActCmpAU	R/W	0x0	<p>Action for Comparator A Up</p> <p>The action to be taken when the counter matches comparator A while counting up. Occurs only when the <code>Mode</code> bit in the PWMnCTL register is set to 1.</p> <p>The table below defines the effect of the event on the output signal.</p> <table border="1"> <thead> <tr> <th>Value</th> <th>Description</th> </tr> </thead> <tbody> <tr> <td>0x0</td> <td>Do nothing.</td> </tr> <tr> <td>0x1</td> <td>Invert the output signal.</td> </tr> <tr> <td>0x2</td> <td>Set the output signal to 0.</td> </tr> <tr> <td>0x3</td> <td>Set the output signal to 1.</td> </tr> </tbody> </table>	Value	Description	0x0	Do nothing.	0x1	Invert the output signal.	0x2	Set the output signal to 0.	0x3	Set the output signal to 1.
Value	Description													
0x0	Do nothing.													
0x1	Invert the output signal.													
0x2	Set the output signal to 0.													
0x3	Set the output signal to 1.													
3:2	ActLoad	R/W	0x0	<p>Action for Counter=Load</p> <p>The action to be taken when the counter matches the load value.</p> <p>The table below defines the effect of the event on the output signal.</p> <table border="1"> <thead> <tr> <th>Value</th> <th>Description</th> </tr> </thead> <tbody> <tr> <td>0x0</td> <td>Do nothing.</td> </tr> <tr> <td>0x1</td> <td>Invert the output signal.</td> </tr> <tr> <td>0x2</td> <td>Set the output signal to 0.</td> </tr> <tr> <td>0x3</td> <td>Set the output signal to 1.</td> </tr> </tbody> </table>	Value	Description	0x0	Do nothing.	0x1	Invert the output signal.	0x2	Set the output signal to 0.	0x3	Set the output signal to 1.
Value	Description													
0x0	Do nothing.													
0x1	Invert the output signal.													
0x2	Set the output signal to 0.													
0x3	Set the output signal to 1.													

Bit/Field	Name	Type	Reset	Description
1:0	ActZero	R/W	0x0	Action for Counter=0 The action to be taken when the counter is zero. The table below defines the effect of the event on the output signal. Value Description 0x0 Do nothing. 0x1 Invert the output signal. 0x2 Set the output signal to 0. 0x3 Set the output signal to 1.

Register 19: PWM Generator B Control (PWM0GENB), offset 0x064

This register controls the generation of the PWM_{nB} signal based on the load and zero output pulses from the counter, as well as the compare A and compare B pulses from the comparators. When the counter is running in Down mode, only four of these events occur; when running in Up/Down mode, all six occur. These events provide great flexibility in the positioning and duty cycle of the PWM signal that is produced.

The **PWM0GENB** register controls generation of the PWM_{0B} signal.

If a zero or load event coincides with a compare A or compare B event, the zero or load action is taken and the compare A or compare B action is ignored. If a compare A event coincides with a compare B event, the compare B action is taken and the compare A action is ignored.

PWM0 Generator B Control (PWM0GENB)

Base 0x4002.8000
 Offset 0x064
 Type R/W, reset 0x0000.0000

	31	30	29	28	27	26	25	24	23	22	21	20	19	18	17	16
	reserved															
Type	RO	RO	RO	RO	RO	RO	RO	RO	RO	RO	RO	RO	RO	RO	RO	RO
Reset	0	0	0	0	0	0	0	0	0	0	0	0	0	0	0	0
	15	14	13	12	11	10	9	8	7	6	5	4	3	2	1	0
	reserved				ActCmpBD	ActCmpBU		ActCmpAD		ActCmpAU		ActLoad		ActZero		
Type	RO	RO	RO	RO	R/W	R/W	R/W	R/W	R/W	R/W	R/W	R/W	R/W	R/W	R/W	R/W
Reset	0	0	0	0	0	0	0	0	0	0	0	0	0	0	0	0

Bit/Field	Name	Type	Reset	Description
31:12	reserved	RO	0x00	Software should not rely on the value of a reserved bit. To provide compatibility with future products, the value of a reserved bit should be preserved across a read-modify-write operation.
11:10	ActCmpBD	R/W	0x0	Action for Comparator B Down The action to be taken when the counter matches comparator B while counting down. The table below defines the effect of the event on the output signal. Value Description 0x0 Do nothing. 0x1 Invert the output signal. 0x2 Set the output signal to 0. 0x3 Set the output signal to 1.

Bit/Field	Name	Type	Reset	Description										
9:8	ActCmpBU	R/W	0x0	<p>Action for Comparator B Up</p> <p>The action to be taken when the counter matches comparator B while counting up. Occurs only when the <code>Mode</code> bit in the PWMnCTL register is set to 1.</p> <p>The table below defines the effect of the event on the output signal.</p> <table border="1"> <thead> <tr> <th>Value</th> <th>Description</th> </tr> </thead> <tbody> <tr> <td>0x0</td> <td>Do nothing.</td> </tr> <tr> <td>0x1</td> <td>Invert the output signal.</td> </tr> <tr> <td>0x2</td> <td>Set the output signal to 0.</td> </tr> <tr> <td>0x3</td> <td>Set the output signal to 1.</td> </tr> </tbody> </table>	Value	Description	0x0	Do nothing.	0x1	Invert the output signal.	0x2	Set the output signal to 0.	0x3	Set the output signal to 1.
Value	Description													
0x0	Do nothing.													
0x1	Invert the output signal.													
0x2	Set the output signal to 0.													
0x3	Set the output signal to 1.													
7:6	ActCmpAD	R/W	0x0	<p>Action for Comparator A Down</p> <p>The action to be taken when the counter matches comparator A while counting down.</p> <p>The table below defines the effect of the event on the output signal.</p> <table border="1"> <thead> <tr> <th>Value</th> <th>Description</th> </tr> </thead> <tbody> <tr> <td>0x0</td> <td>Do nothing.</td> </tr> <tr> <td>0x1</td> <td>Invert the output signal.</td> </tr> <tr> <td>0x2</td> <td>Set the output signal to 0.</td> </tr> <tr> <td>0x3</td> <td>Set the output signal to 1.</td> </tr> </tbody> </table>	Value	Description	0x0	Do nothing.	0x1	Invert the output signal.	0x2	Set the output signal to 0.	0x3	Set the output signal to 1.
Value	Description													
0x0	Do nothing.													
0x1	Invert the output signal.													
0x2	Set the output signal to 0.													
0x3	Set the output signal to 1.													
5:4	ActCmpAU	R/W	0x0	<p>Action for Comparator A Up</p> <p>The action to be taken when the counter matches comparator A while counting up. Occurs only when the <code>Mode</code> bit in the PWMnCTL register is set to 1.</p> <p>The table below defines the effect of the event on the output signal.</p> <table border="1"> <thead> <tr> <th>Value</th> <th>Description</th> </tr> </thead> <tbody> <tr> <td>0x0</td> <td>Do nothing.</td> </tr> <tr> <td>0x1</td> <td>Invert the output signal.</td> </tr> <tr> <td>0x2</td> <td>Set the output signal to 0.</td> </tr> <tr> <td>0x3</td> <td>Set the output signal to 1.</td> </tr> </tbody> </table>	Value	Description	0x0	Do nothing.	0x1	Invert the output signal.	0x2	Set the output signal to 0.	0x3	Set the output signal to 1.
Value	Description													
0x0	Do nothing.													
0x1	Invert the output signal.													
0x2	Set the output signal to 0.													
0x3	Set the output signal to 1.													
3:2	ActLoad	R/W	0x0	<p>Action for Counter=Load</p> <p>The action to be taken when the counter matches the load value.</p> <p>The table below defines the effect of the event on the output signal.</p> <table border="1"> <thead> <tr> <th>Value</th> <th>Description</th> </tr> </thead> <tbody> <tr> <td>0x0</td> <td>Do nothing.</td> </tr> <tr> <td>0x1</td> <td>Invert the output signal.</td> </tr> <tr> <td>0x2</td> <td>Set the output signal to 0.</td> </tr> <tr> <td>0x3</td> <td>Set the output signal to 1.</td> </tr> </tbody> </table>	Value	Description	0x0	Do nothing.	0x1	Invert the output signal.	0x2	Set the output signal to 0.	0x3	Set the output signal to 1.
Value	Description													
0x0	Do nothing.													
0x1	Invert the output signal.													
0x2	Set the output signal to 0.													
0x3	Set the output signal to 1.													

Bit/Field	Name	Type	Reset	Description
1:0	ActZero	R/W	0x0	Action for Counter=0 The action to be taken when the counter is 0. The table below defines the effect of the event on the output signal. Value Description 0x0 Do nothing. 0x1 Invert the output signal. 0x2 Set the output signal to 0. 0x3 Set the output signal to 1.

Register 20: PWM0 Dead-Band Control (PWM0DBCTL), offset 0x068

The **PWM0DBCTL** register controls the dead-band generator, which produces the **PWM0** and **PWM1** signals based on the **PWM0A** and **PWM0B** signals. When disabled, the **PWM0A** signal passes through to the **PWM0** signal and the **PWM0B** signal passes through to the **PWM1** signal. When enabled and inverting the resulting waveform, the **PWM0B** signal is ignored; the **PWM0** signal is generated by delaying the rising edge(s) of the **PWM0A** signal by the value in the **PWM0DBRISE** register (see page 478), and the **PWM1** signal is generated by delaying the falling edge(s) of the **PWM0A** signal by the value in the **PWM0DBFALL** register (see page 479).

PWM0 Dead-Band Control (PWM0DBCTL)

Base 0x4002.8000

Offset 0x068

Type R/W, reset 0x0000.0000

	31	30	29	28	27	26	25	24	23	22	21	20	19	18	17	16
	reserved															
Type	RO	RO	RO	RO	RO	RO	RO	RO	RO	RO	RO	RO	RO	RO	RO	RO
Reset	0	0	0	0	0	0	0	0	0	0	0	0	0	0	0	0
	15	14	13	12	11	10	9	8	7	6	5	4	3	2	1	0
	reserved															Enable
Type	RO	RO	RO	RO	RO	RO	RO	RO	RO	RO	RO	RO	RO	RO	RO	R/W
Reset	0	0	0	0	0	0	0	0	0	0	0	0	0	0	0	0

Bit/Field	Name	Type	Reset	Description
31:1	reserved	RO	0x00	Software should not rely on the value of a reserved bit. To provide compatibility with future products, the value of a reserved bit should be preserved across a read-modify-write operation.
0	Enable	R/W	0	Dead-Band Generator Enable When set, the dead-band generator inserts dead bands into the output signals; when clear, it simply passes the PWM signals through.

Register 21: PWM0 Dead-Band Rising-Edge Delay (PWM0DBRISE), offset 0x06C

The **PWM0DBRISE** register contains the number of clock ticks to delay the rising edge of the **PWM0A** signal when generating the **PWM0** signal. If the dead-band generator is disabled through the **PWMnDBCTL** register, the **PWM0DBRISE** register is ignored. If the value of this register is larger than the width of a High pulse on the input PWM signal, the rising-edge delay consumes the entire High time of the signal, resulting in no High time on the output. Care must be taken to ensure that the input High time always exceeds the rising-edge delay.

PWM0 Dead-Band Rising-Edge Delay (PWM0DBRISE)

Base 0x4002.8000
 Offset 0x06C
 Type R/W, reset 0x0000.0000

	31	30	29	28	27	26	25	24	23	22	21	20	19	18	17	16
	reserved															
Type	RO	RO	RO	RO	RO	RO	RO	RO	RO	RO	RO	RO	RO	RO	RO	RO
Reset	0	0	0	0	0	0	0	0	0	0	0	0	0	0	0	0
	15	14	13	12	11	10	9	8	7	6	5	4	3	2	1	0
	reserved				RiseDelay											
Type	RO	RO	RO	RO	R/W	R/W	R/W	R/W	R/W	R/W	R/W	R/W	R/W	R/W	R/W	R/W
Reset	0	0	0	0	0	0	0	0	0	0	0	0	0	0	0	0

Bit/Field	Name	Type	Reset	Description
31:12	reserved	RO	0x00	Software should not rely on the value of a reserved bit. To provide compatibility with future products, the value of a reserved bit should be preserved across a read-modify-write operation.
11:0	RiseDelay	R/W	0	Dead-Band Rise Delay The number of clock ticks to delay the rising edge.

Register 22: PWM0 Dead-Band Falling-Edge-Delay (PWM0DBFALL), offset 0x070

The **PWM0DBFALL** register contains the number of clock ticks to delay the falling edge of the **PWM0A** signal when generating the **PWM1** signal. If the dead-band generator is disabled, this register is ignored. If the value of this register is larger than the width of a Low pulse on the input PWM signal, the falling-edge delay consumes the entire Low time of the signal, resulting in no Low time on the output. Care must be taken to ensure that the input Low time always exceeds the falling-edge delay.

PWM0 Dead-Band Falling-Edge-Delay (PWM0DBFALL)

Base 0x4002.8000

Offset 0x070

Type R/W, reset 0x0000.0000

	31	30	29	28	27	26	25	24	23	22	21	20	19	18	17	16
	reserved															
Type	RO	RO	RO	RO	RO	RO	RO	RO	RO	RO	RO	RO	RO	RO	RO	RO
Reset	0	0	0	0	0	0	0	0	0	0	0	0	0	0	0	0
	15	14	13	12	11	10	9	8	7	6	5	4	3	2	1	0
	reserved				FallDelay											
Type	RO	RO	RO	RO	R/W	R/W	R/W	R/W	R/W	R/W	R/W	R/W	R/W	R/W	R/W	R/W
Reset	0	0	0	0	0	0	0	0	0	0	0	0	0	0	0	0

Bit/Field	Name	Type	Reset	Description
31:12	reserved	RO	0x00	Software should not rely on the value of a reserved bit. To provide compatibility with future products, the value of a reserved bit should be preserved across a read-modify-write operation.
11:0	FallDelay	R/W	0x00	Dead-Band Fall Delay The number of clock ticks to delay the falling edge.

18 Pin Diagram

Figure 18-1 on page 480 shows the pin diagram and pin-to-signal-name mapping.

Figure 18-1. Pin Connection Diagram

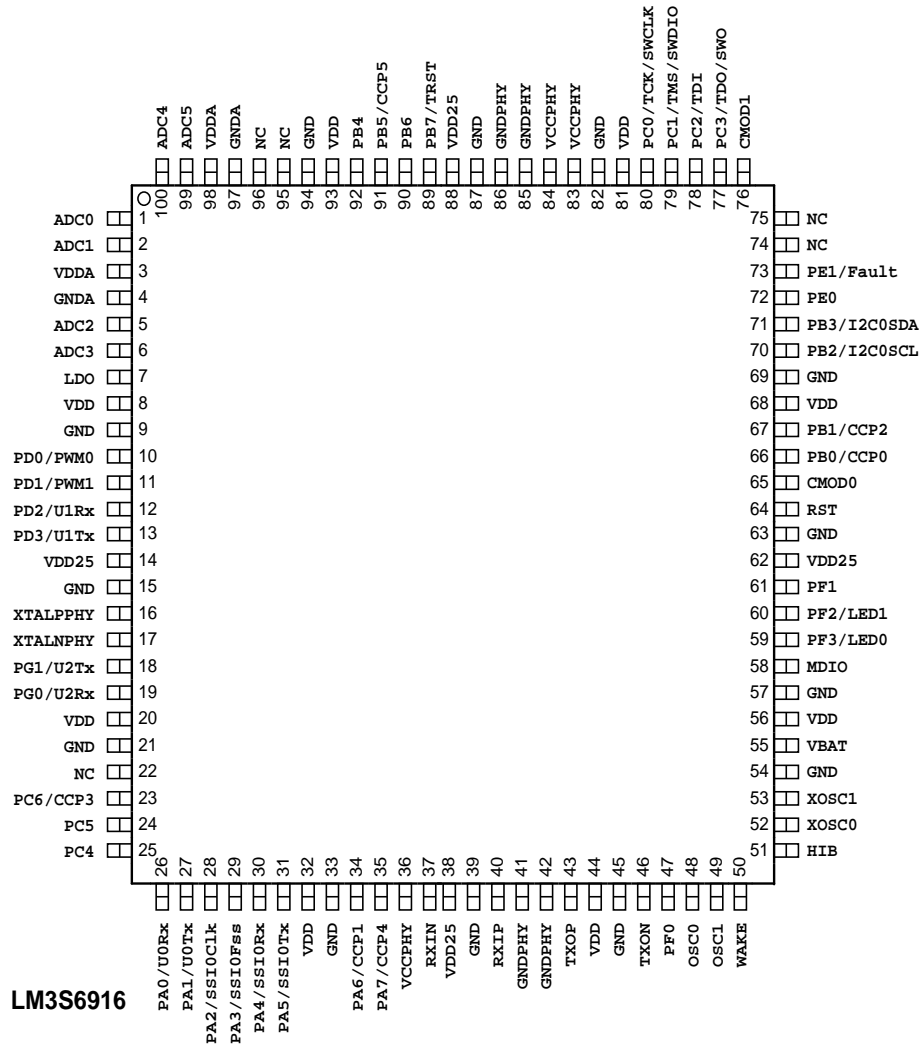

19 Signal Tables

The following tables list the signals available for each pin. Functionality is enabled by software with the **GPIOAFSEL** register.

Important: All multiplexed pins are GPIOs by default, with the exception of the five JTAG pins ($PB7$ and $PC[3:0]$) which default to the JTAG functionality.

Table 19-1 on page 481 shows the pin-to-signal-name mapping, including functional characteristics of the signals. Table 19-2 on page 485 lists the signals in alphabetical order by signal name.

Table 19-3 on page 489 groups the signals by functionality, except for GPIOs. Table 19-4 on page 492 lists the GPIO pins and their alternate functionality.

Table 19-1. Signals by Pin Number

Pin Number	Pin Name	Pin Type	Buffer Type	Description
1	ADC0	I	Analog	Analog-to-digital converter input 0.
2	ADC1	I	Analog	Analog-to-digital converter input 1.
3	VDDA	-	Power	The positive supply (3.3 V) for the analog circuits (ADC, Analog Comparators, etc.). These are separated from VDD to minimize the electrical noise contained on VDD from affecting the analog functions.
4	GNDA	-	Power	The ground reference for the analog circuits (ADC, Analog Comparators, etc.). These are separated from GND to minimize the electrical noise contained on VDD from affecting the analog functions.
5	ADC2	I	Analog	Analog-to-digital converter input 2.
6	ADC3	I	Analog	Analog-to-digital converter input 3.
7	LDO	-	Power	Low drop-out regulator output voltage. This pin requires an external capacitor between the pin and GND of 1 μ F or greater. When the on-chip LDO is used to provide power to the logic, the LDO pin must also be connected to the VDD25 pins at the board level in addition to the decoupling capacitor(s).
8	VDD	-	Power	Positive supply for I/O and some logic.
9	GND	-	Power	Ground reference for logic and I/O pins.
10	PD0	I/O	TTL	GPIO port D bit 0
	PWM0	O	TTL	PWM 0
11	PD1	I/O	TTL	GPIO port D bit 1
	PWM1	O	TTL	PWM 1
12	PD2	I/O	TTL	GPIO port D bit 2
	U1Rx	I	TTL	UART module 1 receive. When in IrDA mode, this signal has IrDA modulation.
13	PD3	I/O	TTL	GPIO port D bit 3
	U1Tx	O	TTL	UART module 1 transmit. When in IrDA mode, this signal has IrDA modulation.

Pin Number	Pin Name	Pin Type	Buffer Type	Description
14	VDD25	-	Power	Positive supply for most of the logic function, including the processor core and most peripherals.
15	GND	-	Power	Ground reference for logic and I/O pins.
16	XTALPPHY	O	TTL	XTALP of the Ethernet PHY
17	XTALNPHY	I	TTL	XTALN of the Ethernet PHY
18	PG1	I/O	TTL	GPIO port G bit 1
	U2Tx	O	TTL	UART 2 Transmit. When in IrDA mode, this signal has IrDA modulation.
19	PG0	I/O	TTL	GPIO port G bit 0
	U2Rx	I	TTL	UART 2 Receive. When in IrDA mode, this signal has IrDA modulation.
20	VDD	-	Power	Positive supply for I/O and some logic.
21	GND	-	Power	Ground reference for logic and I/O pins.
22	NC	-	-	No connect
23	PC6	I/O	TTL	GPIO port C bit 6
	CCP3	I/O	TTL	Capture/Compare/PWM 3
24	PC5	I/O	TTL	GPIO port C bit 5
25	PC4	I/O	TTL	GPIO port C bit 4
26	PA0	I/O	TTL	GPIO port A bit 0
	U0Rx	I	TTL	UART module 0 receive. When in IrDA mode, this signal has IrDA modulation.
27	PA1	I/O	TTL	GPIO port A bit 1
	U0Tx	O	TTL	UART module 0 transmit. When in IrDA mode, this signal has IrDA modulation.
28	PA2	I/O	TTL	GPIO port A bit 2
	SSI0Clk	I/O	TTL	SSI module 0 clock
29	PA3	I/O	TTL	GPIO port A bit 3
	SSI0Fss	I/O	TTL	SSI module 0 frame
30	PA4	I/O	TTL	GPIO port A bit 4
	SSI0Rx	I	TTL	SSI module 0 receive
31	PA5	I/O	TTL	GPIO port A bit 5
	SSI0Tx	O	TTL	SSI module 0 transmit
32	VDD	-	Power	Positive supply for I/O and some logic.
33	GND	-	Power	Ground reference for logic and I/O pins.
34	PA6	I/O	TTL	GPIO port A bit 6
	CCP1	I/O	TTL	Capture/Compare/PWM 1
35	PA7	I/O	TTL	GPIO port A bit 7
	CCP4	I/O	TTL	Capture/Compare/PWM 1
36	VCCPHY	I	TTL	VCC of the Ethernet PHY
37	RXIN	I	Analog	RXIN of the Ethernet PHY
38	VDD25	-	Power	Positive supply for most of the logic function, including the processor core and most peripherals.
39	GND	-	Power	Ground reference for logic and I/O pins.

Pin Number	Pin Name	Pin Type	Buffer Type	Description
40	RXIP	I	Analog	RXIP of the Ethernet PHY
41	GNDPHY	I	TTL	GND of the Ethernet PHY
42	GNDPHY	I	TTL	GND of the Ethernet PHY
43	TXOP	O	Analog	TXOP of the Ethernet PHY
44	VDD	-	Power	Positive supply for I/O and some logic.
45	GND	-	Power	Ground reference for logic and I/O pins.
46	TXON	O	Analog	TXON of the Ethernet PHY
47	PF0	I/O	TTL	GPIO port F bit 0
48	OSC0	I	Analog	Main oscillator crystal input or an external clock reference input.
49	OSC1	I	Analog	Main oscillator crystal output.
50	$\overline{\text{WAKE}}$	I	OD	An external input that brings the processor out of hibernate mode when asserted.
51	$\overline{\text{HIB}}$	O	TTL	An output that indicates the processor is in hibernate mode.
52	XOSC0	I	Analog	Hibernation Module oscillator crystal input or an external clock reference input. Note that this is either a 4.19-MHz crystal or a 32.768-kHz oscillator for the Hibernation Module RTC. See the CLKSEL bit in the HIBCTL register.
53	XOSC1	I	Analog	Hibernation Module oscillator crystal output.
54	GND	-	Power	Ground reference for logic and I/O pins.
55	VBAT	-	Power	Power source for the Hibernation Module. It is normally connected to the positive terminal of a battery and serves as the battery backup/Hibernation Module power-source supply.
56	VDD	-	Power	Positive supply for I/O and some logic.
57	GND	-	Power	Ground reference for logic and I/O pins.
58	MDIO	I/O	TTL	MDIO of the Ethernet PHY
59	PF3	I/O	TTL	GPIO port F bit 3
	LED0	O	TTL	MII LED 0
60	PF2	I/O	TTL	GPIO port F bit 2
	LED1	O	TTL	MII LED 1
61	PF1	I/O	TTL	GPIO port F bit 1
62	VDD25	-	Power	Positive supply for most of the logic function, including the processor core and most peripherals.
63	GND	-	Power	Ground reference for logic and I/O pins.
64	$\overline{\text{RST}}$	I	TTL	System reset input.
65	CMOD0	I/O	TTL	CPU Mode bit 0. Input must be set to logic 0 (grounded); other encodings reserved.
66	PB0	I/O	TTL	GPIO port B bit 0
	CCP0	I/O	TTL	Capture/Compare/PWM 0
67	PB1	I/O	TTL	GPIO port B bit 1
	CCP2	I/O	TTL	Capture/Compare/PWM 2

Pin Number	Pin Name	Pin Type	Buffer Type	Description
68	VDD	-	Power	Positive supply for I/O and some logic.
69	GND	-	Power	Ground reference for logic and I/O pins.
70	PB2	I/O	TTL	GPIO port B bit 2
	I2C0SCL	I/O	OD	I2C module 0 clock
71	PB3	I/O	TTL	GPIO port B bit 3
	I2C0SDA	I/O	OD	I2C module 0 data
72	PE0	I/O	TTL	GPIO port E bit 0
73	PE1	I/O	TTL	GPIO port E bit 1
	Fault	I	TTL	PWM Fault
74	NC	-	-	No connect
75	NC	-	-	No connect
76	CMOD1	I/O	TTL	CPU Mode bit 1. Input must be set to logic 0 (grounded); other encodings reserved.
77	PC3	I/O	TTL	GPIO port C bit 3
	TDO	O	TTL	JTAG TDO and SWO
	SWO	O	TTL	JTAG TDO and SWO
78	PC2	I/O	TTL	GPIO port C bit 2
	TDI	I	TTL	JTAG TDI
79	PC1	I/O	TTL	GPIO port C bit 1
	TMS	I/O	TTL	JTAG TMS and SWDIO
	SWDIO	I/O	TTL	JTAG TMS and SWDIO
80	PC0	I/O	TTL	GPIO port C bit 0
	TCK	I	TTL	JTAG/SWD CLK
	SWCLK	I	TTL	JTAG/SWD CLK
81	VDD	-	Power	Positive supply for I/O and some logic.
82	GND	-	Power	Ground reference for logic and I/O pins.
83	VCCPHY	I	TTL	VCC of the Ethernet PHY
84	VCCPHY	I	TTL	VCC of the Ethernet PHY
85	GNDPHY	I	TTL	GND of the Ethernet PHY
86	GNDPHY	I	TTL	GND of the Ethernet PHY
87	GND	-	Power	Ground reference for logic and I/O pins.
88	VDD25	-	Power	Positive supply for most of the logic function, including the processor core and most peripherals.
89	PB7	I/O	TTL	GPIO port B bit 7
	TRST	I	TTL	JTAG TRSTn
90	PB6	I/O	TTL	GPIO port B bit 6
91	PB5	I/O	TTL	GPIO port B bit 5
	CCP5	I/O	TTL	Capture/Compare/PWM 5
92	PB4	I/O	TTL	GPIO port B bit 4
93	VDD	-	Power	Positive supply for I/O and some logic.
94	GND	-	Power	Ground reference for logic and I/O pins.
95	NC	-	-	No connect

Pin Number	Pin Name	Pin Type	Buffer Type	Description
96	NC	-	-	No connect
97	GNDA	-	Power	The ground reference for the analog circuits (ADC, Analog Comparators, etc.). These are separated from GND to minimize the electrical noise contained on VDD from affecting the analog functions.
98	VDDA	-	Power	The positive supply (3.3 V) for the analog circuits (ADC, Analog Comparators, etc.). These are separated from VDD to minimize the electrical noise contained on VDD from affecting the analog functions.
99	ADC5	I	Analog	Analog-to-digital converter input 5.
100	ADC4	I	Analog	Analog-to-digital converter input 4.

Table 19-2. Signals by Signal Name

Pin Name	Pin Number	Pin Type	Buffer Type	Description
ADC0	1	I	Analog	Analog-to-digital converter input 0.
ADC1	2	I	Analog	Analog-to-digital converter input 1.
ADC2	5	I	Analog	Analog-to-digital converter input 2.
ADC3	6	I	Analog	Analog-to-digital converter input 3.
ADC4	100	I	Analog	Analog-to-digital converter input 4.
ADC5	99	I	Analog	Analog-to-digital converter input 5.
CCP0	66	I/O	TTL	Capture/Compare/PWM 0
CCP1	34	I/O	TTL	Capture/Compare/PWM 1
CCP2	67	I/O	TTL	Capture/Compare/PWM 2
CCP3	23	I/O	TTL	Capture/Compare/PWM 3
CCP4	35	I/O	TTL	Capture/Compare/PWM 1
CCP5	91	I/O	TTL	Capture/Compare/PWM 5
CMOD0	65	I/O	TTL	CPU Mode bit 0. Input must be set to logic 0 (grounded); other encodings reserved.
CMOD1	76	I/O	TTL	CPU Mode bit 1. Input must be set to logic 0 (grounded); other encodings reserved.
Fault	73	I	TTL	PWM Fault
GND	9	-	Power	Ground reference for logic and I/O pins.
GND	15	-	Power	Ground reference for logic and I/O pins.
GND	21	-	Power	Ground reference for logic and I/O pins.
GND	33	-	Power	Ground reference for logic and I/O pins.
GND	39	-	Power	Ground reference for logic and I/O pins.
GND	45	-	Power	Ground reference for logic and I/O pins.
GND	54	-	Power	Ground reference for logic and I/O pins.
GND	57	-	Power	Ground reference for logic and I/O pins.
GND	63	-	Power	Ground reference for logic and I/O pins.
GND	69	-	Power	Ground reference for logic and I/O pins.
GND	82	-	Power	Ground reference for logic and I/O pins.
GND	87	-	Power	Ground reference for logic and I/O pins.
GND	94	-	Power	Ground reference for logic and I/O pins.

Pin Name	Pin Number	Pin Type	Buffer Type	Description
GNDA	4	-	Power	The ground reference for the analog circuits (ADC, Analog Comparators, etc.). These are separated from GND to minimize the electrical noise contained on VDD from affecting the analog functions.
GNDA	97	-	Power	The ground reference for the analog circuits (ADC, Analog Comparators, etc.). These are separated from GND to minimize the electrical noise contained on VDD from affecting the analog functions.
GNDPHY	41	I	TTL	GND of the Ethernet PHY
GNDPHY	42	I	TTL	GND of the Ethernet PHY
GNDPHY	85	I	TTL	GND of the Ethernet PHY
GNDPHY	86	I	TTL	GND of the Ethernet PHY
HIB	51	O	TTL	An output that indicates the processor is in hibernate mode.
I2C0SCL	70	I/O	OD	I2C module 0 clock
I2C0SDA	71	I/O	OD	I2C module 0 data
LDO	7	-	Power	Low drop-out regulator output voltage. This pin requires an external capacitor between the pin and GND of 1 μ F or greater. When the on-chip LDO is used to provide power to the logic, the LDO pin must also be connected to the VDD25 pins at the board level in addition to the decoupling capacitor(s).
LED0	59	O	TTL	MII LED 0
LED1	60	O	TTL	MII LED 1
MDIO	58	I/O	TTL	MDIO of the Ethernet PHY
NC	22	-	-	No connect
NC	74	-	-	No connect
NC	75	-	-	No connect
NC	95	-	-	No connect
NC	96	-	-	No connect
OSC0	48	I	Analog	Main oscillator crystal input or an external clock reference input.
OSC1	49	I	Analog	Main oscillator crystal output.
PA0	26	I/O	TTL	GPIO port A bit 0
PA1	27	I/O	TTL	GPIO port A bit 1
PA2	28	I/O	TTL	GPIO port A bit 2
PA3	29	I/O	TTL	GPIO port A bit 3
PA4	30	I/O	TTL	GPIO port A bit 4
PA5	31	I/O	TTL	GPIO port A bit 5
PA6	34	I/O	TTL	GPIO port A bit 6
PA7	35	I/O	TTL	GPIO port A bit 7
PB0	66	I/O	TTL	GPIO port B bit 0
PB1	67	I/O	TTL	GPIO port B bit 1
PB2	70	I/O	TTL	GPIO port B bit 2

Pin Name	Pin Number	Pin Type	Buffer Type	Description
PB3	71	I/O	TTL	GPIO port B bit 3
PB4	92	I/O	TTL	GPIO port B bit 4
PB5	91	I/O	TTL	GPIO port B bit 5
PB6	90	I/O	TTL	GPIO port B bit 6
PB7	89	I/O	TTL	GPIO port B bit 7
PC0	80	I/O	TTL	GPIO port C bit 0
PC1	79	I/O	TTL	GPIO port C bit 1
PC2	78	I/O	TTL	GPIO port C bit 2
PC3	77	I/O	TTL	GPIO port C bit 3
PC4	25	I/O	TTL	GPIO port C bit 4
PC5	24	I/O	TTL	GPIO port C bit 5
PC6	23	I/O	TTL	GPIO port C bit 6
PD0	10	I/O	TTL	GPIO port D bit 0
PD1	11	I/O	TTL	GPIO port D bit 1
PD2	12	I/O	TTL	GPIO port D bit 2
PD3	13	I/O	TTL	GPIO port D bit 3
PE0	72	I/O	TTL	GPIO port E bit 0
PE1	73	I/O	TTL	GPIO port E bit 1
PF0	47	I/O	TTL	GPIO port F bit 0
PF1	61	I/O	TTL	GPIO port F bit 1
PF2	60	I/O	TTL	GPIO port F bit 2
PF3	59	I/O	TTL	GPIO port F bit 3
PG0	19	I/O	TTL	GPIO port G bit 0
PG1	18	I/O	TTL	GPIO port G bit 1
PWM0	10	O	TTL	PWM 0
PWM1	11	O	TTL	PWM 1
$\overline{\text{RST}}$	64	I	TTL	System reset input.
RXIN	37	I	Analog	RXIN of the Ethernet PHY
RXIP	40	I	Analog	RXIP of the Ethernet PHY
SSI0Clk	28	I/O	TTL	SSI module 0 clock
SSI0Fss	29	I/O	TTL	SSI module 0 frame
SSI0Rx	30	I	TTL	SSI module 0 receive
SSI0Tx	31	O	TTL	SSI module 0 transmit
SWCLK	80	I	TTL	JTAG/SWD CLK
SWDIO	79	I/O	TTL	JTAG TMS and SWDIO
SWO	77	O	TTL	JTAG TDO and SWO
TCK	80	I	TTL	JTAG/SWD CLK
TDI	78	I	TTL	JTAG TDI
TDO	77	O	TTL	JTAG TDO and SWO
TMS	79	I/O	TTL	JTAG TMS and SWDIO
TRST	89	I	TTL	JTAG TRSTn
TXON	46	O	Analog	TXON of the Ethernet PHY

Pin Name	Pin Number	Pin Type	Buffer Type	Description
TXOP	43	O	Analog	TXOP of the Ethernet PHY
U0Rx	26	I	TTL	UART module 0 receive. When in IrDA mode, this signal has IrDA modulation.
U0Tx	27	O	TTL	UART module 0 transmit. When in IrDA mode, this signal has IrDA modulation.
U1Rx	12	I	TTL	UART module 1 receive. When in IrDA mode, this signal has IrDA modulation.
U1Tx	13	O	TTL	UART module 1 transmit. When in IrDA mode, this signal has IrDA modulation.
U2Rx	19	I	TTL	UART 2 Receive. When in IrDA mode, this signal has IrDA modulation.
U2Tx	18	O	TTL	UART 2 Transmit. When in IrDA mode, this signal has IrDA modulation.
VBAT	55	-	Power	Power source for the Hibernation Module. It is normally connected to the positive terminal of a battery and serves as the battery backup/Hibernation Module power-source supply.
VCCPHY	36	I	TTL	VCC of the Ethernet PHY
VCCPHY	83	I	TTL	VCC of the Ethernet PHY
VCCPHY	84	I	TTL	VCC of the Ethernet PHY
VDD	8	-	Power	Positive supply for I/O and some logic.
VDD	20	-	Power	Positive supply for I/O and some logic.
VDD	32	-	Power	Positive supply for I/O and some logic.
VDD	44	-	Power	Positive supply for I/O and some logic.
VDD	56	-	Power	Positive supply for I/O and some logic.
VDD	68	-	Power	Positive supply for I/O and some logic.
VDD	81	-	Power	Positive supply for I/O and some logic.
VDD	93	-	Power	Positive supply for I/O and some logic.
VDD25	14	-	Power	Positive supply for most of the logic function, including the processor core and most peripherals.
VDD25	38	-	Power	Positive supply for most of the logic function, including the processor core and most peripherals.
VDD25	62	-	Power	Positive supply for most of the logic function, including the processor core and most peripherals.
VDD25	88	-	Power	Positive supply for most of the logic function, including the processor core and most peripherals.
VDDA	3	-	Power	The positive supply (3.3 V) for the analog circuits (ADC, Analog Comparators, etc.). These are separated from VDD to minimize the electrical noise contained on VDD from affecting the analog functions.
VDDA	98	-	Power	The positive supply (3.3 V) for the analog circuits (ADC, Analog Comparators, etc.). These are separated from VDD to minimize the electrical noise contained on VDD from affecting the analog functions.

Pin Name	Pin Number	Pin Type	Buffer Type	Description
$\overline{\text{WAKE}}$	50	I	OD	An external input that brings the processor out of hibernate mode when asserted.
XOSC0	52	I	Analog	Hibernation Module oscillator crystal input or an external clock reference input. Note that this is either a 4.19-MHz crystal or a 32.768-kHz oscillator for the Hibernation Module RTC. See the CLKSEL bit in the HIBCTL register.
XOSC1	53	I	Analog	Hibernation Module oscillator crystal output.
XTALNPHY	17	I	TTL	XTALN of the Ethernet PHY
XTALPPHY	16	O	TTL	XTALP of the Ethernet PHY

Table 19-3. Signals by Function, Except for GPIO

Function	Pin Name	Pin Number	Pin Type	Buffer Type	Description
ADC	ADC0	1	I	Analog	Analog-to-digital converter input 0.
	ADC1	2	I	Analog	Analog-to-digital converter input 1.
	ADC2	5	I	Analog	Analog-to-digital converter input 2.
	ADC3	6	I	Analog	Analog-to-digital converter input 3.
	ADC4	100	I	Analog	Analog-to-digital converter input 4.
	ADC5	99	I	Analog	Analog-to-digital converter input 5.
Ethernet PHY	GNDPHY	41	I	TTL	GND of the Ethernet PHY
	GNDPHY	42	I	TTL	GND of the Ethernet PHY
	GNDPHY	85	I	TTL	GND of the Ethernet PHY
	GNDPHY	86	I	TTL	GND of the Ethernet PHY
	LED0	59	O	TTL	MII LED 0
	LED1	60	O	TTL	MII LED 1
	MDIO	58	I/O	TTL	MDIO of the Ethernet PHY
	RXIN	37	I	Analog	RXIN of the Ethernet PHY
	RXIP	40	I	Analog	RXIP of the Ethernet PHY
	TXON	46	O	Analog	TXON of the Ethernet PHY
	TXOP	43	O	Analog	TXOP of the Ethernet PHY
	VCCPHY	36	I	TTL	VCC of the Ethernet PHY
	VCCPHY	83	I	TTL	VCC of the Ethernet PHY
	VCCPHY	84	I	TTL	VCC of the Ethernet PHY
XTALNPHY	17	I	TTL	XTALN of the Ethernet PHY	
XTALPPHY	16	O	TTL	XTALP of the Ethernet PHY	
General-Purpose Timers	CCP0	66	I/O	TTL	Capture/Compare/PWM 0
	CCP1	34	I/O	TTL	Capture/Compare/PWM 1
	CCP2	67	I/O	TTL	Capture/Compare/PWM 2
	CCP3	23	I/O	TTL	Capture/Compare/PWM 3
	CCP4	35	I/O	TTL	Capture/Compare/PWM 1
	CCP5	91	I/O	TTL	Capture/Compare/PWM 5
I2C	I2C0SCL	70	I/O	OD	I2C module 0 clock
	I2C0SDA	71	I/O	OD	I2C module 0 data

Function	Pin Name	Pin Number	Pin Type	Buffer Type	Description
JTAG/SWD/SWO	SWCLK	80	I	TTL	JTAG/SWD CLK
	SWDIO	79	I/O	TTL	JTAG TMS and SWDIO
	SWO	77	O	TTL	JTAG TDO and SWO
	TCK	80	I	TTL	JTAG/SWD CLK
	TDI	78	I	TTL	JTAG TDI
	TDO	77	O	TTL	JTAG TDO and SWO
	TMS	79	I/O	TTL	JTAG TMS and SWDIO
PWM	Fault	73	I	TTL	PWM Fault
	PWM0	10	O	TTL	PWM 0
	PWM1	11	O	TTL	PWM 1

Function	Pin Name	Pin Number	Pin Type	Buffer Type	Description
Power	GND	9	-	Power	Ground reference for logic and I/O pins.
	GND	15	-	Power	Ground reference for logic and I/O pins.
	GND	21	-	Power	Ground reference for logic and I/O pins.
	GND	33	-	Power	Ground reference for logic and I/O pins.
	GND	39	-	Power	Ground reference for logic and I/O pins.
	GND	45	-	Power	Ground reference for logic and I/O pins.
	GND	54	-	Power	Ground reference for logic and I/O pins.
	GND	57	-	Power	Ground reference for logic and I/O pins.
	GND	63	-	Power	Ground reference for logic and I/O pins.
	GND	69	-	Power	Ground reference for logic and I/O pins.
	GND	82	-	Power	Ground reference for logic and I/O pins.
	GND	87	-	Power	Ground reference for logic and I/O pins.
	GND	94	-	Power	Ground reference for logic and I/O pins.
	GND _A	4	-	Power	The ground reference for the analog circuits (ADC, Analog Comparators, etc.). These are separated from GND to minimize the electrical noise contained on VDD from affecting the analog functions.
	GND _A	97	-	Power	The ground reference for the analog circuits (ADC, Analog Comparators, etc.). These are separated from GND to minimize the electrical noise contained on VDD from affecting the analog functions.
	HIB	51	O	TTL	An output that indicates the processor is in hibernate mode.
	LDO	7	-	Power	Low drop-out regulator output voltage. This pin requires an external capacitor between the pin and GND of 1 μ F or greater. When the on-chip LDO is used to provide power to the logic, the LDO pin must also be connected to the VDD25 pins at the board level in addition to the decoupling capacitor(s).
	VBAT	55	-	Power	Power source for the Hibernation Module. It is normally connected to the positive terminal of a battery and serves as the battery backup/Hibernation Module power-source supply.
	VDD	8	-	Power	Positive supply for I/O and some logic.
	VDD	20	-	Power	Positive supply for I/O and some logic.
	VDD	32	-	Power	Positive supply for I/O and some logic.
	VDD	44	-	Power	Positive supply for I/O and some logic.
	VDD	56	-	Power	Positive supply for I/O and some logic.
	VDD	68	-	Power	Positive supply for I/O and some logic.
	VDD	81	-	Power	Positive supply for I/O and some logic.
	VDD	93	-	Power	Positive supply for I/O and some logic.
VDD25	14	-	Power	Positive supply for most of the logic function, including the processor core and most peripherals.	
VDD25	38	-	Power	Positive supply for most of the logic function, including the processor core and most peripherals.	
VDD25	62	-	Power	Positive supply for most of the logic function, including the processor core and most peripherals.	

Function	Pin Name	Pin Number	Pin Type	Buffer Type	Description
	VDD25	88	-	Power	Positive supply for most of the logic function, including the processor core and most peripherals.
	VDDA	3	-	Power	The positive supply (3.3 V) for the analog circuits (ADC, Analog Comparators, etc.). These are separated from VDD to minimize the electrical noise contained on VDD from affecting the analog functions.
	VDDA	98	-	Power	The positive supply (3.3 V) for the analog circuits (ADC, Analog Comparators, etc.). These are separated from VDD to minimize the electrical noise contained on VDD from affecting the analog functions.
	$\overline{\text{WAKE}}$	50	I	OD	An external input that brings the processor out of hibernate mode when asserted.
SSI	SSI0Clk	28	I/O	TTL	SSI module 0 clock
	SSI0Fss	29	I/O	TTL	SSI module 0 frame
	SSI0Rx	30	I	TTL	SSI module 0 receive
	SSI0Tx	31	O	TTL	SSI module 0 transmit
System Control & Clocks	CMOD0	65	I/O	TTL	CPU Mode bit 0. Input must be set to logic 0 (grounded); other encodings reserved.
	CMOD1	76	I/O	TTL	CPU Mode bit 1. Input must be set to logic 0 (grounded); other encodings reserved.
	OSC0	48	I	Analog	Main oscillator crystal input or an external clock reference input.
	OSC1	49	I	Analog	Main oscillator crystal output.
	$\overline{\text{RST}}$	64	I	TTL	System reset input.
	$\overline{\text{TRST}}$	89	I	TTL	JTAG TRSTn
	XOSC0	52	I	Analog	Hibernation Module oscillator crystal input or an external clock reference input. Note that this is either a 4.19-MHz crystal or a 32.768-kHz oscillator for the Hibernation Module RTC. See the CLKSEL bit in the HIBCTL register.
	XOSC1	53	I	Analog	Hibernation Module oscillator crystal output.
UART	U0Rx	26	I	TTL	UART module 0 receive. When in IrDA mode, this signal has IrDA modulation.
	U0Tx	27	O	TTL	UART module 0 transmit. When in IrDA mode, this signal has IrDA modulation.
	U1Rx	12	I	TTL	UART module 1 receive. When in IrDA mode, this signal has IrDA modulation.
	U1Tx	13	O	TTL	UART module 1 transmit. When in IrDA mode, this signal has IrDA modulation.
	U2Rx	19	I	TTL	UART 2 Receive. When in IrDA mode, this signal has IrDA modulation.
	U2Tx	18	O	TTL	UART 2 Transmit. When in IrDA mode, this signal has IrDA modulation.

Table 19-4. GPIO Pins and Alternate Functions

GPIO Pin	Pin Number	Multiplexed Function	Multiplexed Function
PA0	26	U0Rx	

GPIO Pin	Pin Number	Multiplexed Function	Multiplexed Function
PA1	27	U0Tx	
PA2	28	SSI0Clk	
PA3	29	SSI0Fss	
PA4	30	SSI0Rx	
PA5	31	SSI0Tx	
PA6	34	CCP1	
PA7	35	CCP4	
PB0	66	CCP0	
PB1	67	CCP2	
PB2	70	I2C0SCL	
PB3	71	I2C0SDA	
PB4	92		
PB5	91	CCP5	
PB6	90		
PB7	89	$\overline{\text{TRST}}$	
PC0	80	TCK	SWCLK
PC1	79	TMS	SWDIO
PC2	78	TDI	
PC3	77	TDO	SWO
PC4	25		
PC5	24		
PC6	23	CCP3	
PD0	10	PWM0	
PD1	11	PWM1	
PD2	12	U1Rx	
PD3	13	U1Tx	
PE0	72		
PE1	73	Fault	
PF0	47		
PF1	61		
PF2	60	LED1	
PF3	59	LED0	
PG0	19	U2Rx	
PG1	18	U2Tx	

20 Operating Characteristics

Table 20-1. Temperature Characteristics

Characteristic	Symbol	Value	Unit
Operating temperature range ^a	T_A	-40 to +85	°C

a. Maximum storage temperature is 150°C.

Table 20-2. Thermal Characteristics

Characteristic	Symbol	Value	Unit
Thermal resistance (junction to ambient) ^a	Θ_{JA}	55.3	°C/W
Average junction temperature ^b	T_J	$T_A + (P_{AVG} \cdot \Theta_{JA})$	°C

a. Junction to ambient thermal resistance Θ_{JA} numbers are determined by a package simulator.

b. Power dissipation is a function of temperature.

21 Electrical Characteristics

21.1 DC Characteristics

21.1.1 Maximum Ratings

The maximum ratings are the limits to which the device can be subjected without permanently damaging the device.

Note: The device is not guaranteed to operate properly at the maximum ratings.

Table 21-1. Maximum Ratings

Characteristic ^a	Symbol	Value		Unit
		Min	Max	
I/O supply voltage (V_{DD})	V_{DD}	0	4	V
Core supply voltage (V_{DD25})	V_{DD25}	0	4	V
Analog supply voltage (V_{DDA})	V_{DDA}	0	4	V
Battery supply voltage (V_{BAT})	V_{BAT}	0	4	V
Ethernet PHY supply voltage (V_{CCPHY})	V_{CCPHY}	0	4	V
Input voltage	V_{IN}	-0.3	5.5	V
Maximum current per output pins	I	-	25	mA

a. Voltages are measured with respect to GND.

Important: This device contains circuitry to protect the inputs against damage due to high-static voltages or electric fields; however, it is advised that normal precautions be taken to avoid application of any voltage higher than maximum-rated voltages to this high-impedance circuit. Reliability of operation is enhanced if unused inputs are connected to an appropriate logic voltage level (for example, either GND or V_{DD}).

21.1.2 Recommended DC Operating Conditions

Table 21-2. Recommended DC Operating Conditions

Parameter	Parameter Name	Min	Nom	Max	Unit
V_{DD}	I/O supply voltage	3.0	3.3	3.6	V
V_{DD25}	Core supply voltage	2.25	2.5	2.75	V
V_{DDA}	Analog supply voltage	3.0	3.3	3.6	V
V_{BAT}	Battery supply voltage	2.3	3.0	3.6	V
V_{CCPHY}	Ethernet PHY supply voltage	3.0	3.3	3.6	V
V_{IH}	High-level input voltage	2.0	-	5.0	V
V_{IL}	Low-level input voltage	-0.3	-	1.3	V
V_{SIH}	High-level input voltage for Schmitt trigger inputs	$0.8 * V_{DD}$	-	V_{DD}	V
V_{SIL}	Low-level input voltage for Schmitt trigger inputs	0	-	$0.2 * V_{DD}$	V
V_{OH}	High-level output voltage	2.4	-	-	V
V_{OL}	Low-level output voltage	-	-	0.4	V

Parameter	Parameter Name	Min	Nom	Max	Unit
I _{OH}	High-level source current, V _{OH} =2.4 V				
	2-mA Drive	2.0	-	-	mA
	4-mA Drive	4.0	-	-	mA
	8-mA Drive	8.0	-	-	mA
I _{OL}	Low-level sink current, V _{OL} =0.4 V				
	2-mA Drive	2.0	-	-	mA
	4-mA Drive	4.0	-	-	mA
	8-mA Drive	8.0	-	-	mA

21.1.3 On-Chip Low Drop-Out (LDO) Regulator Characteristics

Table 21-3. LDO Regulator Characteristics

Parameter	Parameter Name	Min	Nom	Max	Unit
V _{LDOOUT}	Programmable internal (logic) power supply output value	2.25	2.5	2.75	V
	Output voltage accuracy	-	2%	-	%
t _{PON}	Power-on time	-	-	100	μs
t _{ON}	Time on	-	-	200	μs
t _{OFF}	Time off	-	-	100	μs
V _{STEP}	Step programming incremental voltage	-	50	-	mV
C _{LDO}	External filter capacitor size for internal power supply	1.0	-	3.0	μF

21.1.4 Power Specifications

The power measurements specified in the tables that follow are run on the core processor using SRAM with the following specifications (except as noted):

- V_{DD} = 3.3 V
- V_{DD25} = 2.50 V
- V_{BAT} = 3.0 V
- V_{DDA} = 3.3 V
- V_{DDPHY} = 3.3 V
- Temperature = 25°C
- Clock Source (MOSC) = 3.579545 MHz Crystal Oscillator
- Main oscillator (MOSC) = enabled
- Internal oscillator (IOSC) = disabled

Table 21-4. Detailed Power Specifications

Parameter	Parameter Name	Conditions	3.3 V V_{DD} , V_{DDA} , V_{DDPHY}		2.5 V V_{DD25}		3.0 V V_{BAT}		Unit
			Nom	Max	Nom	Max	Nom	Max	
I_{DD_RUN}	Run mode 1 (Flash loop)	$V_{DD25} = 2.50$ V Code= while(1){} executed in Flash Peripherals = All ON System Clock = 50 MHz (with PLL)	48	pending ^a	108	pending ^a	0	pending ^a	mA
	Run mode 2 (Flash loop)	$V_{DD25} = 2.50$ V Code= while(1){} executed in Flash Peripherals = All OFF System Clock = 50 MHz (with PLL)	5	pending ^a	52	pending ^a	0	pending ^a	mA
	Run mode 1 (SRAM loop)	$V_{DD25} = 2.50$ V Code= while(1){} executed in SRAM Peripherals = All ON System Clock = 50 MHz (with PLL)	48	pending ^a	100	pending ^a	0	pending ^a	mA
	Run mode 2 (SRAM loop)	$V_{DD25} = 2.50$ V Code= while(1){} executed in SRAM Peripherals = All OFF System Clock = 50 MHz (with PLL)	5	pending ^a	45	pending ^a	0	pending ^a	mA
I_{DD_SLEEP}	Sleep mode	$V_{DD25} = 2.50$ V Peripherals = All OFF System Clock = 50 MHz (with PLL)	5	pending ^a	16	pending ^a	0	pending ^a	mA
$I_{DD_DEEPSLEEP}$	Deep-Sleep mode	LDO = 2.25 V Peripherals = All OFF System Clock = IOS30KHZ/64	4.6	pending ^a	0.21	pending ^a	0	pending ^a	mA
$I_{DD_HIBERNATE}$	Hibernate mode	$V_{BAT} = 3.0$ V $V_{DD} = 0$ V $V_{DD25} = 0$ V $V_{DDA} = 0$ V $V_{DDPHY} = 0$ V Peripherals = All OFF System Clock = OFF Hibernate Module = 32 kHz	0	pending ^a	0	pending ^a	16	pending ^a	μ A

a. Pending characterization completion.

21.1.5 Flash Memory Characteristics

Table 21-5. Flash Memory Characteristics

Parameter	Parameter Name	Min	Nom	Max	Unit
PE _{CYC}	Number of guaranteed program/erase cycles before failure ^a	10,000	100,000	-	cycles
T _{RET}	Data retention at average operating temperature of 85°C	10	-	-	years
T _{PROG}	Word program time	20	-	-	μs
T _{ERASE}	Page erase time	20	-	-	ms
T _{ME}	Mass erase time	200	-	-	ms

a. A program/erase cycle is defined as switching the bits from 1-> 0 -> 1.

21.2 AC Characteristics

21.2.1 Load Conditions

Unless otherwise specified, the following conditions are true for all timing measurements. Timing measurements are for 4-mA drive strength.

Figure 21-1. Load Conditions

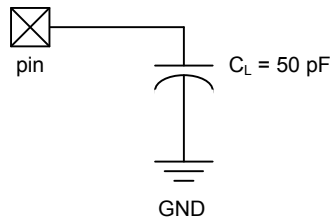

21.2.2 Clocks

Table 21-6. Phase Locked Loop (PLL) Characteristics

Parameter	Parameter Name	Min	Nom	Max	Unit
f _{ref_crystal}	Crystal reference ^a	3.579545	-	8.192	MHz
f _{ref_ext}	External clock reference ^a	3.579545	-	8.192	MHz
f _{pll}	PLL frequency ^b	-	400	-	MHz
T _{READY}	PLL lock time	-	-	0.5	ms

a. The exact value is determined by the crystal value programmed into the XTAL field of the **Run-Mode Clock Configuration (RCC)** register.

b. PLL frequency is automatically calculated by the hardware based on the XTAL field of the **RCC** register.

Table 21-7. Clock Characteristics

Parameter	Parameter Name	Min	Nom	Max	Unit
f _{IOSC}	Internal 12 MHz oscillator frequency	8.4	12	15.6	MHz
f _{IOSC30KHZ}	Internal 30 KHz oscillator frequency	21	30	39	KHz
f _{XOSC}	Hibernation module oscillator frequency	-	4.194304	-	MHz
f _{XOSC_XTAL}	Crystal reference for hibernation oscillator	-	4.194304	-	MHz
f _{XOSC_EXT}	External clock reference for hibernation module	-	32.768	-	KHz

Parameter	Parameter Name	Min	Nom	Max	Unit
f _{MOSC}	Main oscillator frequency	1	-	8	MHz
t _{MOSC_per}	Main oscillator period	125	-	1000	ns
f _{ref_crystal_bypass}	Crystal reference using the main oscillator (PLL in BYPASS mode) ^a	1	-	8	MHz
f _{ref_ext_bypass}	External clock reference (PLL in BYPASS mode) ^a	0	-	50	MHz
f _{system_clock}	System clock	0	-	50	MHz

a. The ADC must be clocked from the PLL or directly from a 14-MHz to 18-MHz clock source to operate properly.

Table 21-8. Crystal Characteristics

Parameter Name	Value				Units
	8	6	4	3.5	
Frequency	8	6	4	3.5	MHz
Frequency tolerance	±50	±50	±50	±50	ppm
Aging	±5	±5	±5	±5	ppm/yr
Oscillation mode	Parallel	Parallel	Parallel	Parallel	
Temperature stability (0 - 85 °C)	±25	±25	±25	±25	ppm
Motional capacitance (typ)	27.8	37.0	55.6	63.5	pF
Motional inductance (typ)	14.3	19.1	28.6	32.7	mH
Equivalent series resistance (max)	120	160	200	220	Ω
Shunt capacitance (max)	10	10	10	10	pF
Load capacitance (typ)	16	16	16	16	pF
Drive level (typ)	100	100	100	100	μW

21.2.3 Analog-to-Digital Converter

Table 21-9. ADC Characteristics

Parameter	Parameter Name	Min	Nom	Max	Unit
V _{ADCIN}	Maximum single-ended, full-scale analog input voltage	-	-	3.0	V
	Minimum single-ended, full-scale analog input voltage	-	-	0	V
	Maximum differential, full-scale analog input voltage	-	-	1.5	V
	Minimum differential, full-scale analog input voltage	-	-	-1.5	V
C _{ADCIN}	Equivalent input capacitance	-	1	-	pF
N	Resolution	-	10	-	bits
f _{ADC}	ADC internal clock frequency	7	8	9	MHz
t _{ADCCONV}	Conversion time	-	-	16	t _{ADC} cycles ^a
f _{ADCCONV}	Conversion rate	438	500	563	k samples/s
INL	Integral nonlinearity	-	-	±1	LSB
DNL	Differential nonlinearity	-	-	±1	LSB
OFF	Offset	-	-	±1	LSB
GAIN	Gain	-	-	±1	LSB

a. $t_{ADC} = 1/f_{ADC \text{ clock}}$

21.2.4 I²C

Table 21-10. I²C Characteristics

Parameter No.	Parameter	Parameter Name	Min	Nom	Max	Unit
I1 ^a	t _{SCH}	Start condition hold time	36	-	-	system clocks
I2 ^a	t _{LP}	Clock Low period	36	-	-	system clocks
I3 ^b	t _{SRT}	I ² C _{SCL} /I ² C _{SDA} rise time (V _{IL} =0.5 V to V _{IH} =2.4 V)	-	-	(see note b)	ns
I4 ^a	t _{DH}	Data hold time	2	-	-	system clocks
I5 ^c	t _{SFT}	I ² C _{SCL} /I ² C _{SDA} fall time (V _{IH} =2.4 V to V _{IL} =0.5 V)	-	9	10	ns
I6 ^a	t _{HT}	Clock High time	24	-	-	system clocks
I7 ^a	t _{DS}	Data setup time	18	-	-	system clocks
I8 ^a	t _{SCSR}	Start condition setup time (for repeated start condition only)	36	-	-	system clocks
I9 ^a	t _{SCS}	Stop condition setup time	24	-	-	system clocks

- a. Values depend on the value programmed into the TPR bit in the I²C Master Timer Period (I2CMTPR) register; a TPR programmed for the maximum I²C_{SCL} frequency (TPR=0x2) results in a minimum output timing as shown in the table above. The I²C interface is designed to scale the actual data transition time to move it to the middle of the I²C_{SCL} Low period. The actual position is affected by the value programmed into the TPR; however, the numbers given in the above values are minimum values.
- b. Because I²C_{SCL} and I²C_{SDA} are open-drain-type outputs, which the controller can only actively drive Low, the time I²C_{SCL} or I²C_{SDA} takes to reach a high level depends on external signal capacitance and pull-up resistor values.
- c. Specified at a nominal 50 pF load.

Figure 21-2. I²C Timing

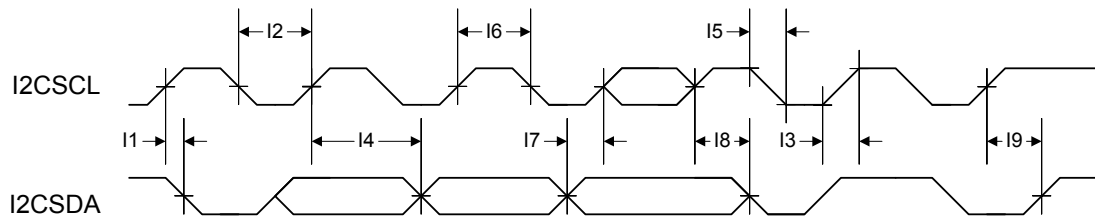

21.2.5 Ethernet Controller

Table 21-11. 100BASE-TX Transmitter Characteristics^a

Parameter Name	Min	Nom	Max	Unit
Peak output amplitude	950	-	1050	mVpk
Output amplitude symmetry	0.98	-	1.02	mVpk
Output overshoot	-	-	5	%
Rise/Fall time	3	-	5	ns
Rise/Fall time imbalance	-	-	500	ps
Duty cycle distortion	-	-	-	ps
Jitter	-	-	1.4	ns

- a. Measured at the line side of the transformer.

Table 21-12. 100BASE-TX Transmitter Characteristics (informative)^a

Parameter Name	Min	Nom	Max	Unit
Return loss	16	-	-	dB
Open-circuit inductance	350	-	-	μs

a. The specifications in this table are included for information only. They are mainly a function of the external transformer and termination resistors used for measurements.

Table 21-13. 100BASE-TX Receiver Characteristics

Parameter Name	Min	Nom	Max	Unit
Signal detect assertion threshold	600	700		mVppd
Signal detect de-assertion threshold	350	425	-	mVppd
Differential input resistance	20	-	-	kΩ
Jitter tolerance (pk-pk)	4	-	-	ns
Baseline wander tracking	-75	-	+75	%
Signal detect assertion time	-	-	1000	μs
Signal detect de-assertion time	-	-	4	μs

Table 21-14. 10BASE-T Transmitter Characteristics^a

Parameter Name	Min	Nom	Max	Unit
Peak differential output signal	2.2	-	2.8	V
Harmonic content	27	-	-	dB
Link pulse width	-	100	-	ns
Start-of-idle pulse width	-	300	-	ns
		350		

a. The Manchester-encoded data pulses, the link pulse and the start-of-idle pulse are tested against the templates and using the procedures found in Clause 14 of *IEEE 802.3*.

Table 21-15. 10BASE-T Transmitter Characteristics (informative)^a

Parameter Name	Min	Nom	Max	Unit
Output return loss	15	-	-	dB
Output impedance balance	29-17log(f/10)	-	-	dB
Peak common-mode output voltage	-	-	50	mV
Common-mode rejection	-	-	100	mV
Common-mode rejection jitter	-	-	1	ns

a. The specifications in this table are included for information only. They are mainly a function of the external transformer and termination resistors used for measurements.

Table 21-16. 10BASE-T Receiver Characteristics

Parameter Name	Min	Nom	Max	Unit
DLL phase acquisition time	-	10	-	BT
Jitter tolerance (pk-pk)	30	-	-	ns
Input squelched threshold	500	600	700	mVppd
Input unsquelched threshold	275	350	425	mVppd
Differential input resistance	-	20	-	kΩ
Bit error ratio	-	10 ⁻¹⁰	-	-

Parameter Name	Min	Nom	Max	Unit
Common-mode rejection	25	-	-	V

Table 21-17. Isolation Transformers^a

Name	Value	Condition
Turns ratio	1 CT : 1 CT	+/- 5%
Open-circuit inductance	350 uH (min)	@ 10 mV, 10 kHz
Leakage inductance	0.40 uH (max)	@ 1 MHz (min)
Inter-winding capacitance	25 pF (max)	
DC resistance	0.9 Ohm (max)	
Insertion loss	0.4 dB (typ)	0-65 MHz
HIPOT	1500	Vrms

a. Two simple 1:1 isolation transformers are required at the line interface. Transformers with integrated common-mode chokes are recommended for exceeding FCC requirements. This table gives the recommended line transformer characteristics.

Note: The 100Base-TX amplitude specifications assume a transformer loss of 0.4 dB. For the transmit line transformer with higher insertion losses, up to 1.2 dB of insertion loss can be compensated by selecting the appropriate setting in the Transmit Amplitude Selection (TXO) bits in the **MR19** register.

Table 21-18. Ethernet Reference Crystal^a

Name	Value	Condition
Frequency	25.00000	MHz
Load capacitance ^b	4 ^c	pF
Frequency tolerance	±50	PPM
Aging	±2	PPM/yr
Temperature stability (0° to 70°)	±5	PPM
Oscillation mode	Parallel resonance, fundamental mode	
Parameters at 25° C ±2° C; Drive level = 0.5 mW		
Drive level (typ)	50-100	µW
Shunt capacitance (max)	10	pF
Motional capacitance (min)	10	fF
Serious resistance (max)	60	Ω
Spurious response (max)	> 5 dB below main within 500 kHz	

a. If the internal crystal oscillator is used, select a crystal with the following characteristics.

b. Equivalent differential capacitance across XTLP/XTLN.

c. If crystal with a larger load is used, external shunt capacitors to ground should be added to make up the equivalent capacitance difference.

Figure 21-3. External XTLP Oscillator Characteristics

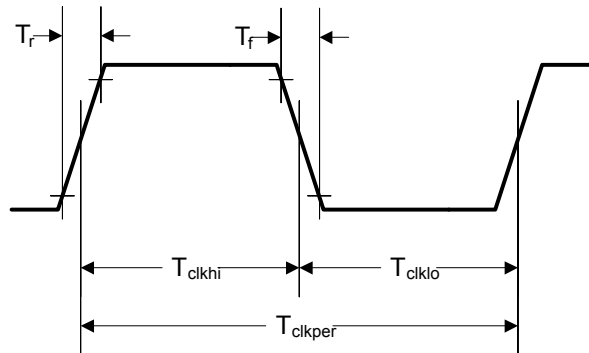

Table 21-19. External XTLP Oscillator Characteristics

Parameter Name	Symbol	Min	Nom	Max	Unit
XTLN Input Low Voltage	XTLN _{ILV}	-	-	0.8	-
XTLP Frequency ^a	XTLP _f	-	25.0	-	-
XTLP Period ^b	T _{clkper}	-	40	-	-
XTLP Duty Cycle	XTLP _{DC}	40	-	60	%
Rise/Fall Time	T _r , T _f	-	-	4.0	ns
Absolute Jitter		-	-	0.1	ns

a. IEEE 802.3 frequency tolerance ± 50 ppm.

b. IEEE 802.3 frequency tolerance ± 50 ppm.

21.2.6 Hibernation Module

The Hibernation Module requires special system implementation considerations since it is intended to power-down all other sections of its host device. The system power-supply distribution and interfaces of the system must be driven to 0 V_{DC} or powered down with the same regulator controlled by $\overline{\text{HIB}}$.

The regulators controlled by $\overline{\text{HIB}}$ are expected to have a settling time of 250 μs or less.

Table 21-20. Hibernation Module Characteristics

Parameter No	Parameter	Parameter Name	Min	Nom	Max	Unit
H1	t _{HIB_LOW}	Internal 32.768 KHz clock reference rising edge to /HIB asserted	-	200	-	μs
H2	t _{HIB_HIGH}	Internal 32.768 KHz clock reference rising edge to /HIB deasserted	-	30	-	μs
H3	t _{WAKE_ASSERT}	/WAKE assertion time	62	-	-	μs
H4	t _{WAKETOHIB}	/WAKE assert to /HIB desassert	62	-	124	μs
H5	t _{XOSC_SETTLE}	XOSC settling time ^a	20	-	-	ms
H6	t _{HIB_REG_WRITE}	Time for a write to non-volatile registers in HIB module to complete	92	-	-	μs

Parameter No	Parameter	Parameter Name	Min	Nom	Max	Unit
H7	$t_{HIB_TO_VDD}$	\overline{HIB} deassert to VDD and VDD25 at minimum operational level	-	-	250	μs

a. This parameter is highly sensitive to PCB layout and trace lengths, which may make this parameter time longer. Care must be taken in PCB design to minimize trace lengths and RLC (resistance, inductance, capacitance).

Figure 21-4. Hibernation Module Timing

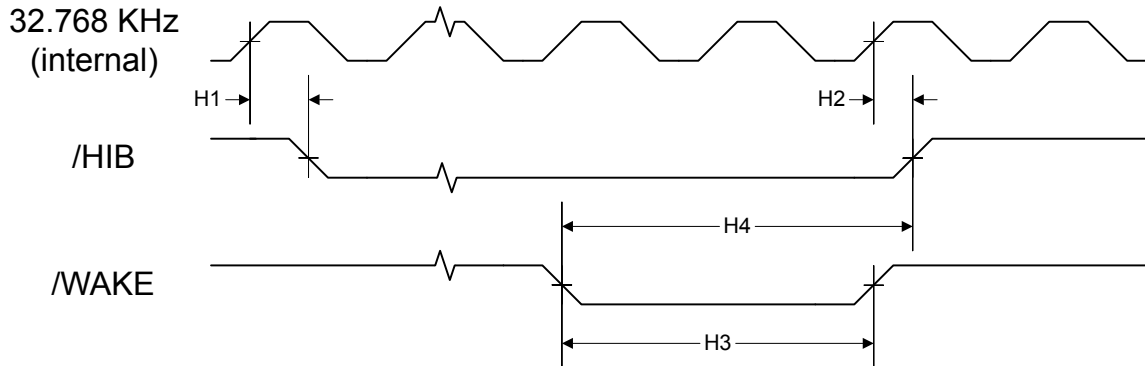

21.2.7 Synchronous Serial Interface (SSI)

Table 21-21. SSI Characteristics

Parameter No.	Parameter	Parameter Name	Min	Nom	Max	Unit
S1	t_{clk_per}	SSIClk cycle time	2	-	65024	system clocks
S2	t_{clk_high}	SSIClk high time	-	1/2	-	t_{clk_per}
S3	t_{clk_low}	SSIClk low time	-	1/2	-	t_{clk_per}
S4	t_{clkrf}	SSIClk rise/fall time	-	7.4	26	ns
S5	t_{DMd}	Data from master valid delay time	0	-	20	ns
S6	t_{DMs}	Data from master setup time	20	-	-	ns
S7	t_{DMh}	Data from master hold time	40	-	-	ns
S8	t_{DSs}	Data from slave setup time	20	-	-	ns
S9	t_{DSh}	Data from slave hold time	40	-	-	ns

Figure 21-5. SSI Timing for TI Frame Format (FRF=01), Single Transfer Timing Measurement

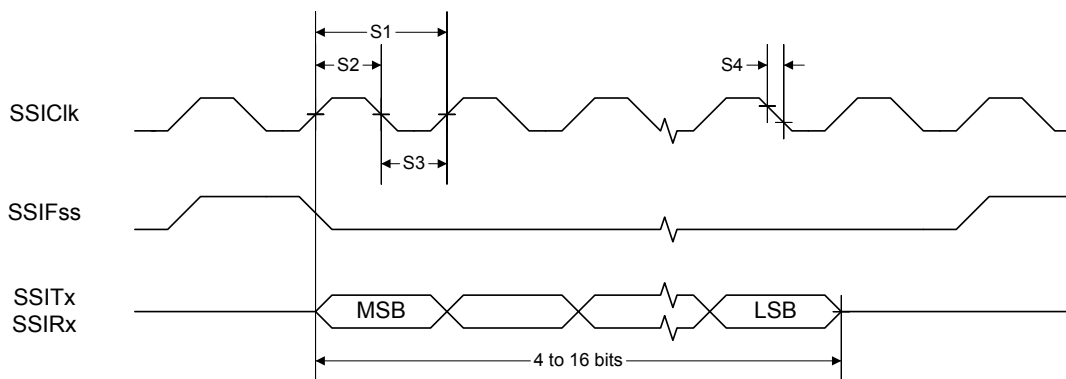

Figure 21-6. SSI Timing for MICROWIRE Frame Format (FRF=10), Single Transfer

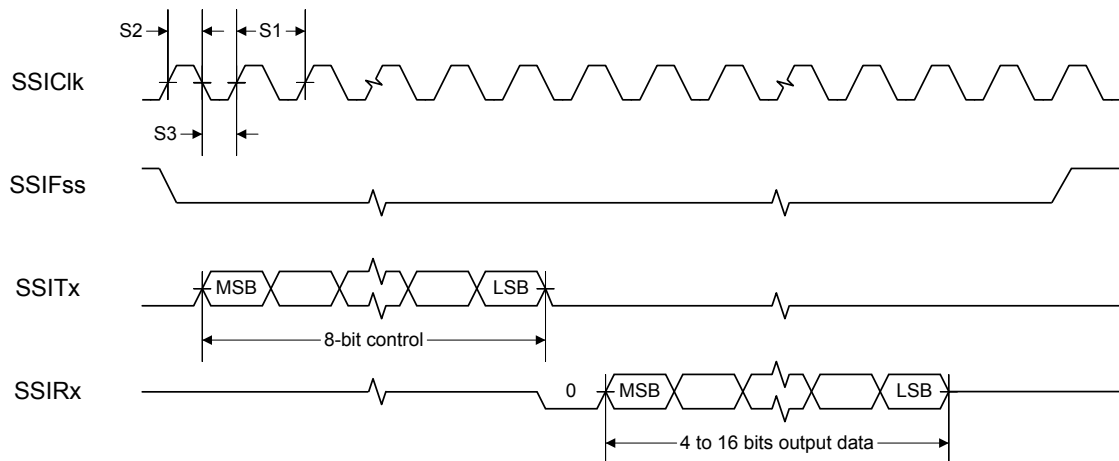
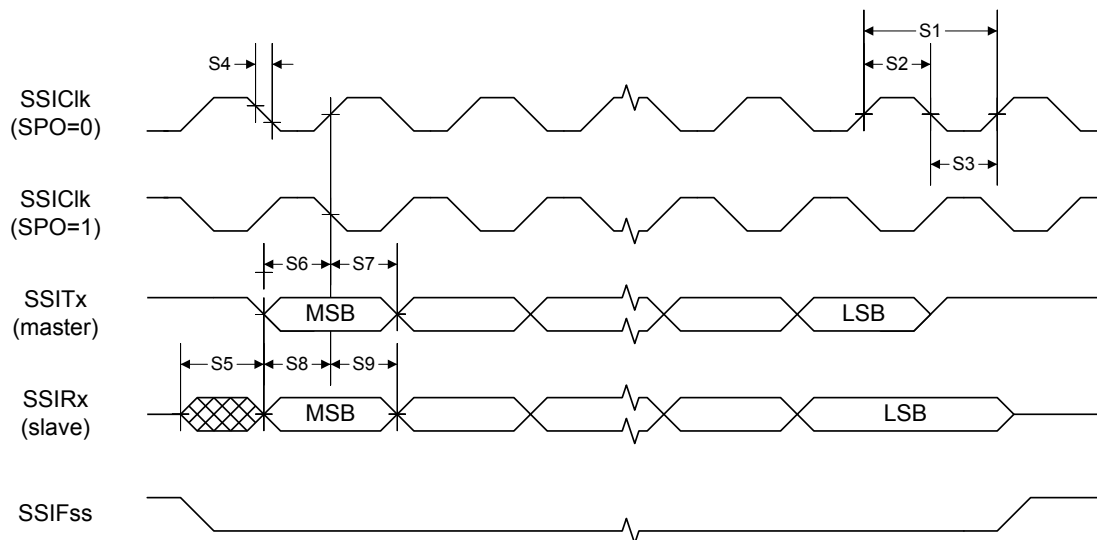

Figure 21-7. SSI Timing for SPI Frame Format (FRF=00), with SPH=1



21.2.8 JTAG and Boundary Scan

Table 21-22. JTAG Characteristics

Parameter No.	Parameter	Parameter Name	Min	Nom	Max	Unit
J1	f_{TCK}	TCK operational clock frequency	0	-	10	MHz
J2	t_{TCK}	TCK operational clock period	100	-	-	ns
J3	t_{TCK_LOW}	TCK clock Low time	-	t_{TCK}	-	ns

Parameter No.	Parameter	Parameter Name	Min	Nom	Max	Unit
J4	t_{TCK_HIGH}	TCK clock High time	-	t_{TCK}	-	ns
J5	t_{TCK_R}	TCK rise time	0	-	10	ns
J6	t_{TCK_F}	TCK fall time	0	-	10	ns
J7	t_{TMS_SU}	TMS setup time to TCK rise	20	-	-	ns
J8	t_{TMS_HLD}	TMS hold time from TCK rise	20	-	-	ns
J9	t_{TDI_SU}	TDI setup time to TCK rise	25	-	-	ns
J10	t_{TDI_HLD}	TDI hold time from TCK rise	25	-	-	ns
J11 t_{TDO_ZDV}	TCK fall to Data Valid from High-Z	2-mA drive	-	23	35	ns
		4-mA drive		15	26	ns
		8-mA drive		14	25	ns
		8-mA drive with slew rate control		18	29	ns
J12 t_{TDO_DV}	TCK fall to Data Valid from Data Valid	2-mA drive	-	21	35	ns
		4-mA drive		14	25	ns
		8-mA drive		13	24	ns
		8-mA drive with slew rate control		18	28	ns
J13 t_{TDO_DVZ}	TCK fall to High-Z from Data Valid	2-mA drive	-	9	11	ns
		4-mA drive		7	9	ns
		8-mA drive		6	8	ns
		8-mA drive with slew rate control		7	9	ns
J14	t_{TRST}	\overline{TRST} assertion time	100	-	-	ns
J15	t_{TRST_SU}	\overline{TRST} setup time to TCK rise	10	-	-	ns

Figure 21-8. JTAG Test Clock Input Timing

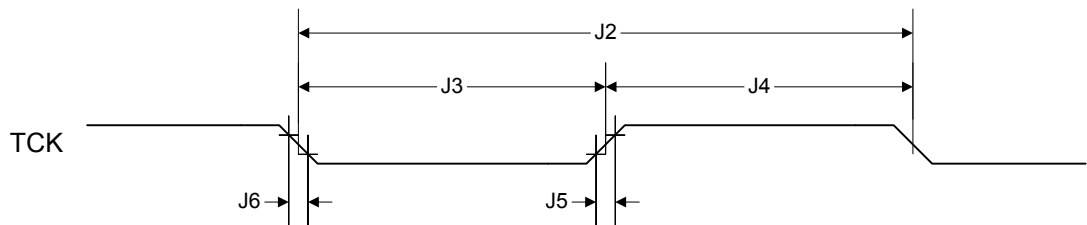

Figure 21-9. JTAG Test Access Port (TAP) Timing

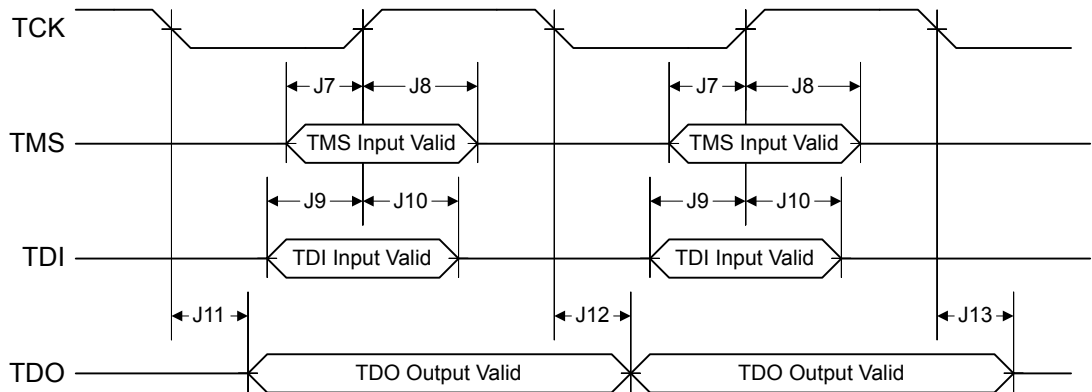
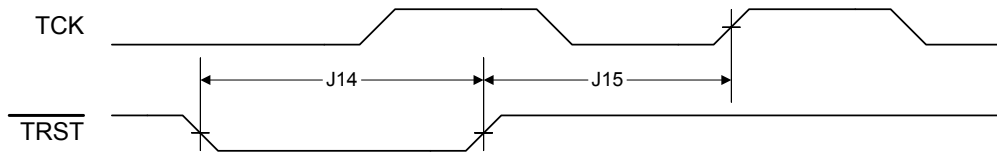

Figure 21-10. JTAG TRST Timing



21.2.9 General-Purpose I/O

Note: All GPIOs are 5 V-tolerant.

Table 21-23. GPIO Characteristics

Parameter	Parameter Name	Condition	Min	Nom	Max	Unit
$t_{GPIO\text{R}}$	GPIO Rise Time (from 20% to 80% of V_{DD})	2-mA drive	-	17	26	ns
		4-mA drive		9	13	ns
		8-mA drive		6	9	ns
		8-mA drive with slew rate control		10	12	ns
$t_{GPIO\text{F}}$	GPIO Fall Time (from 80% to 20% of V_{DD})	2-mA drive	-	17	25	ns
		4-mA drive		8	12	ns
		8-mA drive		6	10	ns
		8-mA drive with slew rate control		11	13	ns

21.2.10 Reset

Table 21-24. Reset Characteristics

Parameter No.	Parameter	Parameter Name	Min	Nom	Max	Unit
R1	V_{TH}	Reset threshold	-	2.0	-	V

Parameter No.	Parameter	Parameter Name	Min	Nom	Max	Unit
R2	V_{BTH}	Brown-Out threshold	2.85	2.9	2.95	V
R3	T_{POR}	Power-On Reset timeout	-	10	-	ms
R4	T_{BOR}	Brown-Out timeout	-	500	-	μ s
R5	T_{IRPOR}	Internal reset timeout after POR	6	-	11	ms
R6	T_{IRBOR}	Internal reset timeout after BOR ^a	0	-	1	μ s
R7	T_{IRHWR}	Internal reset timeout after hardware reset (\overline{RST} pin)	0	-	1	ms
R8	T_{IRSWR}	Internal reset timeout after software-initiated system reset ^a	2.5	-	20	μ s
R9	T_{IRWDR}	Internal reset timeout after watchdog reset ^a	2.5	-	20	μ s
R10	$T_{VDDRISE}$	Supply voltage (V_{DD}) rise time (0V-3.3V)	-	-	100	ms
R11	T_{MIN}	Minimum \overline{RST} pulse width	2	-	-	μ s

a. $20 * t_{MOSC_per}$

Figure 21-11. External Reset Timing (\overline{RST})

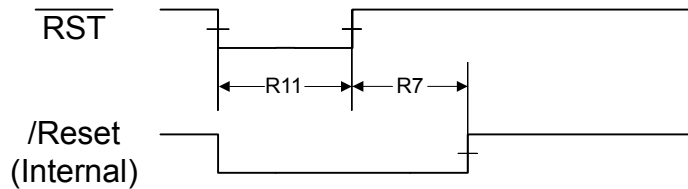

Figure 21-12. Power-On Reset Timing

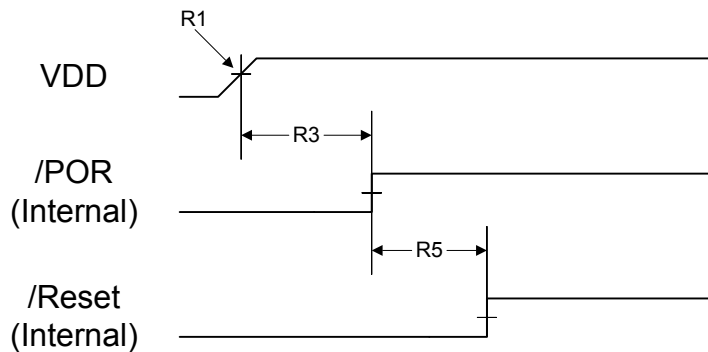

Figure 21-13. Brown-Out Reset Timing

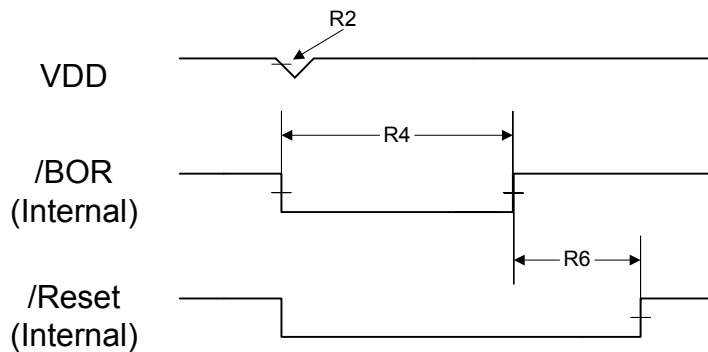
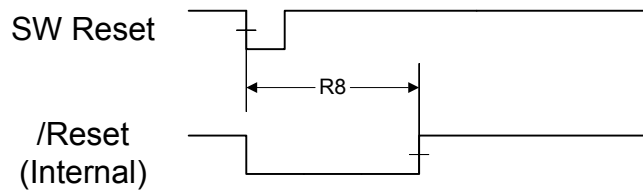
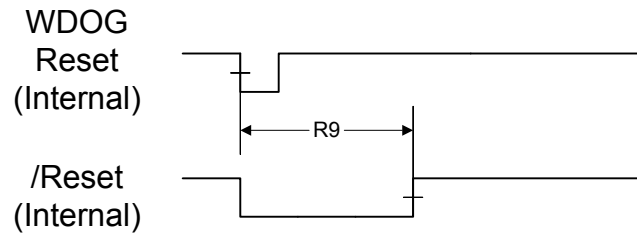
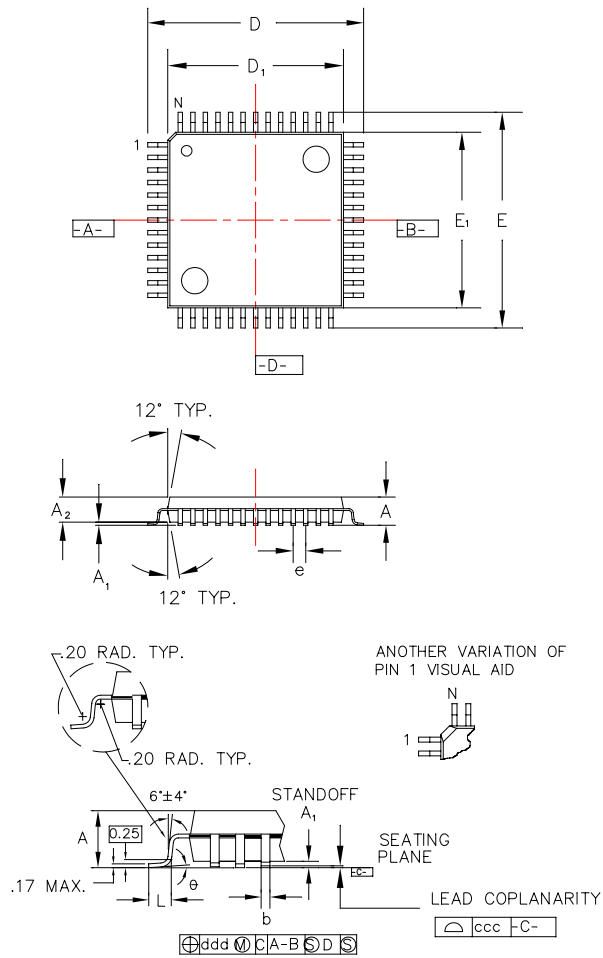

Figure 21-14. Software Reset Timing**Figure 21-15. Watchdog Reset Timing**

22 Package Information

Figure 22-1. 100-Pin LQFP Package



Note: The following notes apply to the package drawing.

1. All dimensions shown in mm.
2. Dimensions shown are nominal with tolerances indicated.
3. Foot length 'L' is measured at gage plane 0.25 mm above seating plane.

Body +2.00 mm Footprint, 1.4 mm package thickness		
Symbols	Leads	100L
A	Max.	1.60
A ₁		0.05 Min./0.15 Max.
A ₂	±0.05	1.40
D	±0.20	16.00
D ₁	±0.05	14.00
E	±0.20	16.00
E ₁	±0.05	14.00
L	±0.15/-0.10	0.60
e	BASIC	0.50
b	±0.05	0.22
θ	===	0°~7°
ddd	Max.	0.08
ccc	Max.	0.08
JEDEC Reference Drawing		MS-026
Variation Designator		BED

A Serial Flash Loader

A.1 Serial Flash Loader

The Stellaris[®] serial flash loader is a preprogrammed flash-resident utility used to download code to the flash memory of a device without the use of a debug interface. The serial flash loader uses a simple packet interface to provide synchronous communication with the device. The flash loader runs off the crystal and does not enable the PLL, so its speed is determined by the crystal used. The two serial interfaces that can be used are the UART0 and SSI0 interfaces. For simplicity, both the data format and communication protocol are identical for both serial interfaces.

A.2 Interfaces

Once communication with the flash loader is established via one of the serial interfaces, that interface is used until the flash loader is reset or new code takes over. For example, once you start communicating using the SSI port, communications with the flash loader via the UART are disabled until the device is reset.

A.2.1 UART

The Universal Asynchronous Receivers/Transmitters (UART) communication uses a fixed serial format of 8 bits of data, no parity, and 1 stop bit. The baud rate used for communication is automatically detected by the flash loader and can be any valid baud rate supported by the host and the device. The auto detection sequence requires that the baud rate should be no more than 1/32 the crystal frequency of the board that is running the serial flash loader. This is actually the same as the hardware limitation for the maximum baud rate for any UART on a Stellaris[®] device which is calculated as follows:

$$\text{Max Baud Rate} = \text{System Clock Frequency} / 16$$

In order to determine the baud rate, the serial flash loader needs to determine the relationship between its own crystal frequency and the baud rate. This is enough information for the flash loader to configure its UART to the same baud rate as the host. This automatic baud-rate detection allows the host to use any valid baud rate that it wants to communicate with the device.

The method used to perform this automatic synchronization relies on the host sending the flash loader two bytes that are both 0x55. This generates a series of pulses to the flash loader that it can use to calculate the ratios needed to program the UART to match the host's baud rate. After the host sends the pattern, it attempts to read back one byte of data from the UART. The flash loader returns the value of 0xCC to indicate successful detection of the baud rate. If this byte is not received after at least twice the time required to transfer the two bytes, the host can resend another pattern of 0x55, 0x55, and wait for the 0xCC byte again until the flash loader acknowledges that it has received a synchronization pattern correctly. For example, the time to wait for data back from the flash loader should be calculated as at least $2 * (20(\text{bits}/\text{sync}) / \text{baud rate} (\text{bits}/\text{sec}))$. For a baud rate of 115200, this time is $2 * (20 / 115200)$ or 0.35 ms.

A.2.2 SSI

The Synchronous Serial Interface (SSI) port also uses a fixed serial format for communications, with the framing defined as Motorola format with SPH set to 1 and SPO set to 1. See "Frame Formats" on page 331 in the SSI chapter for more information on formats for this transfer protocol. Like the UART, this interface has hardware requirements that limit the maximum speed that the SSI clock can run. This allows the SSI clock to be at most 1/12 the crystal frequency of the board running

the flash loader. Since the host device is the master, the SSI on the flash loader device does not need to determine the clock as it is provided directly by the host.

A.3 Packet Handling

All communications, with the exception of the UART auto-baud, are done via defined packets that are acknowledged (ACK) or not acknowledged (NAK) by the devices. The packets use the same format for receiving and sending packets, including the method used to acknowledge successful or unsuccessful reception of a packet.

A.3.1 Packet Format

All packets sent and received from the device use the following byte-packed format.

```
struct
{
    unsigned char ucSize;
    unsigned char ucChecksum;
    unsigned char Data[];
};
```

ucSize	The first byte received holds the total size of the transfer including the size and checksum bytes.
ucChecksum	This holds a simple checksum of the bytes in the data buffer only. The algorithm is $Data[0]+Data[1]+\dots+Data[ucSize-3]$.
Data	This is the raw data intended for the device, which is formatted in some form of command interface. There should be $ucSize-2$ bytes of data provided in this buffer to or from the device.

A.3.2 Sending Packets

The actual bytes of the packet can be sent individually or all at once; the only limitation is that commands that cause flash memory access should limit the download sizes to prevent losing bytes during flash programming. This limitation is discussed further in the section that describes the serial flash loader command, `COMMAND_SEND_DATA` (see “`COMMAND_SEND_DATA (0x24)`” on page 515).

Once the packet has been formatted correctly by the host, it should be sent out over the UART or SSI interface. Then the host should poll the UART or SSI interface for the first non-zero data returned from the device. The first non-zero byte will either be an ACK (0xCC) or a NAK (0x33) byte from the device indicating the packet was received successfully (ACK) or unsuccessfully (NAK). This does not indicate that the actual contents of the command issued in the data portion of the packet were valid, just that the packet was received correctly.

A.3.3 Receiving Packets

The flash loader sends a packet of data in the same format that it receives a packet. The flash loader may transfer leading zero data before the first actual byte of data is sent out. The first non-zero byte is the size of the packet followed by a checksum byte, and finally followed by the data itself. There is no break in the data after the first non-zero byte is sent from the flash loader. Once the device communicating with the flash loader receives all the bytes, it must either ACK or NAK the packet to indicate that the transmission was successful. The appropriate response after sending a NAK to the flash loader is to resend the command that failed and request the data again. If needed, the host may send leading zeros before sending down the ACK/NAK signal to the flash loader, as the

flash loader only accepts the first non-zero data as a valid response. This zero padding is needed by the SSI interface in order to receive data to or from the flash loader.

A.4 Commands

The next section defines the list of commands that can be sent to the flash loader. The first byte of the data should always be one of the defined commands, followed by data or parameters as determined by the command that is sent.

A.4.1 COMMAND_PING (0x20)

This command simply accepts the command and sets the global status to success. The format of the packet is as follows:

```
Byte[0] = 0x03;  
Byte[1] = checksum(Byte[2]);  
Byte[2] = COMMAND_PING;
```

The ping command has 3 bytes and the value for `COMMAND_PING` is 0x20 and the checksum of one byte is that same byte, making `Byte[1]` also 0x20. Since the ping command has no real return status, the receipt of an ACK can be interpreted as a successful ping to the flash loader.

A.4.2 COMMAND_GET_STATUS (0x23)

This command returns the status of the last command that was issued. Typically, this command should be sent after every command to ensure that the previous command was successful or to properly respond to a failure. The command requires one byte in the data of the packet and should be followed by reading a packet with one byte of data that contains a status code. The last step is to ACK or NAK the received data so the flash loader knows that the data has been read.

```
Byte[0] = 0x03  
Byte[1] = checksum(Byte[2])  
Byte[2] = COMMAND_GET_STATUS
```

A.4.3 COMMAND_DOWNLOAD (0x21)

This command is sent to the flash loader to indicate where to store data and how many bytes will be sent by the `COMMAND_SEND_DATA` commands that follow. The command consists of two 32-bit values that are both transferred MSB first. The first 32-bit value is the address to start programming data into, while the second is the 32-bit size of the data that will be sent. This command also triggers an erase of the full area to be programmed so this command takes longer than other commands. This results in a longer time to receive the ACK/NAK back from the board. This command should be followed by a `COMMAND_GET_STATUS` to ensure that the Program Address and Program size are valid for the device running the flash loader.

The format of the packet to send this command is a follows:

```
Byte[0] = 11  
Byte[1] = checksum(Bytes[2:10])  
Byte[2] = COMMAND_DOWNLOAD  
Byte[3] = Program Address [31:24]  
Byte[4] = Program Address [23:16]  
Byte[5] = Program Address [15:8]  
Byte[6] = Program Address [7:0]  
Byte[7] = Program Size [31:24]
```

```

Byte[8] = Program Size [23:16]
Byte[9] = Program Size [15:8]
Byte[10] = Program Size [7:0]

```

A.4.4 **COMMAND_SEND_DATA (0x24)**

This command should only follow a `COMMAND_DOWNLOAD` command or another `COMMAND_SEND_DATA` command if more data is needed. Consecutive send data commands automatically increment address and continue programming from the previous location. The caller should limit transfers of data to a maximum 8 bytes of packet data to allow the flash to program successfully and not overflow input buffers of the serial interfaces. The command terminates programming once the number of bytes indicated by the `COMMAND_DOWNLOAD` command has been received. Each time this function is called it should be followed by a `COMMAND_GET_STATUS` to ensure that the data was successfully programmed into the flash. If the flash loader sends a NAK to this command, the flash loader does not increment the current address to allow retransmission of the previous data.

```

Byte[0] = 11
Byte[1] = checksum(Bytes[2:10])
Byte[2] = COMMAND_SEND_DATA
Byte[3] = Data[0]
Byte[4] = Data[1]
Byte[5] = Data[2]
Byte[6] = Data[3]
Byte[7] = Data[4]
Byte[8] = Data[5]
Byte[9] = Data[6]
Byte[10] = Data[7]

```

A.4.5 **COMMAND_RUN (0x22)**

This command is used to tell the flash loader to execute from the address passed as the parameter in this command. This command consists of a single 32-bit value that is interpreted as the address to execute. The 32-bit value is transmitted MSB first and the flash loader responds with an ACK signal back to the host device before actually executing the code at the given address. This allows the host to know that the command was received successfully and the code is now running.

```

Byte[0] = 7
Byte[1] = checksum(Bytes[2:6])
Byte[2] = COMMAND_RUN
Byte[3] = Execute Address[31:24]
Byte[4] = Execute Address[23:16]
Byte[5] = Execute Address[15:8]
Byte[6] = Execute Address[7:0]

```

A.4.6 **COMMAND_RESET (0x25)**

This command is used to tell the flash loader device to reset. This is useful when downloading a new image that overwrote the flash loader and wants to start from a full reset. Unlike the `COMMAND_RUN` command, this allows the initial stack pointer to be read by the hardware and set up for the new code. It can also be used to reset the flash loader if a critical error occurs and the host device wants to restart communication with the flash loader.

```
Byte[0] = 3  
Byte[1] = checksum(Byte[2])  
Byte[2] = COMMAND_RESET
```

The flash loader responds with an ACK signal back to the host device before actually executing the software reset to the device running the flash loader. This allows the host to know that the command was received successfully and the part will be reset.

B Register Quick Reference

31	30	29	28	27	26	25	24	23	22	21	20	19	18	17	16										
15	14	13	12	11	10	9	8	7	6	5	4	3	2	1	0										
System Control																									
Base 0x400F.E000																									
DID0, type RO, offset 0x000, reset -																									
VER								CLASS																	
MAJOR								MINOR																	
PBORCTL, type R/W, offset 0x030, reset 0x0000.7FFD																									
														BORIOR											
LDOPTL, type R/W, offset 0x034, reset 0x0000.0000																									
														VADJ											
RIS, type RO, offset 0x050, reset 0x0000.0000																									
								PLLRIS				BORRIS													
IMC, type R/W, offset 0x054, reset 0x0000.0000																									
								PLLLIM				BORIM													
MISC, type R/W1C, offset 0x058, reset 0x0000.0000																									
								PLLLMIS				BORMIS													
RESC, type R/W, offset 0x05C, reset -																									
								LDO		SW		WDT		BOR		POR		EXT							
RCC, type R/W, offset 0x060, reset 0x07AE.3AD1																									
PWRDN				ACG		SYSDIV				USESYS		USEPWMDIV		PWMDIV											
				BYPASS		XTAL				OSCSRC				IOSCDIS		MOSCDIS									
PLLCFG, type RO, offset 0x064, reset -																									
F								R																	
RCC2, type R/W, offset 0x070, reset 0x0780.2800																									
USERCC2				SYSDIV2																					
PWRDN2				BYPASS2						OSCSRC2															
DSLPLCLKCFG, type R/W, offset 0x144, reset 0x0780.0000																									
DSDIVORIDE								DSOSCSRC																	
DID1, type RO, offset 0x004, reset -																									
VER				FAM				PARTNO																	
PINCOUNT								TEMP		PKG		ROHS		QUAL											
DC0, type RO, offset 0x008, reset 0x00FF.007F																									
SRAMSZ								FLASHSZ																	
DC1, type RO, offset 0x010, reset 0x0011.32DF																									
MINSYS				MAXADCSPD				MPU		HIB		PWM		ADC											
								PLL		WDT		SWO		SWD		JTAG									
DC2, type RO, offset 0x014, reset 0x000F.1017																									
I2C0								SSI0		TIMER3		TIMER2		TIMER1		TIMER0									
										UART2		UART1		UART0											
DC3, type RO, offset 0x018, reset 0x3F3F.8003																									
CCP5				CCP4		CCP3		CCP2		CCP1		CCP0		ADC5		ADC4		ADC3		ADC2		ADC1		ADC0	
PMMFAULT																				PMM1		PMM0			

31	30	29	28	27	26	25	24	23	22	21	20	19	18	17	16
15	14	13	12	11	10	9	8	7	6	5	4	3	2	1	0
HIBCTL, type R/W, offset 0x010, reset 0x0000.0000															
								VABORT	CLK32EN	LOWBATEN	PINWEN	RTCWEN	CLKSEL	HIBREQ	RTCEN
HIBIM, type R/W, offset 0x014, reset 0x0000.0000															
												EXTW	LOWBAT	RTCAL1	RTCAL0
HIBRIS, type RO, offset 0x018, reset 0x0000.0000															
												EXTW	LOWBAT	RTCAL1	RTCAL0
HIBMIS, type RO, offset 0x01C, reset 0x0000.0000															
												EXTW	LOWBAT	RTCAL1	RTCAL0
HIBIC, type R/W1C, offset 0x020, reset 0x0000.0000															
												EXTW	LOWBAT	RTCAL1	RTCAL0
HIBRTCT, type R/W, offset 0x024, reset 0x0000.7FFF															
TRIM															
HIBDATA, type R/W, offset 0x030-0x12C, reset 0x0000.0000															
RTD															
RTD															
Internal Memory															
Flash Control Offset															
Base 0x400F.D000															
FMA, type R/W, offset 0x000, reset 0x0000.0000															
												OFFSET			
OFFSET															
FMD, type R/W, offset 0x004, reset 0x0000.0000															
DATA															
DATA															
FMC, type R/W, offset 0x008, reset 0x0000.0000															
WRKEY															
												COMT	MERASE	ERASE	WRITE
FCRIS, type RO, offset 0x00C, reset 0x0000.0000															
														PRIS	ARIS
FCIM, type R/W, offset 0x010, reset 0x0000.0000															
														PMASK	AMASK
FCMISC, type R/W1C, offset 0x014, reset 0x0000.0000															
														PMISC	AMISC
Internal Memory															
System Control Offset															
Base 0x400F.E000															
USEACL, type R/W, offset 0x140, reset 0x31															
												USEC			
FMPRE0, type R/W, offset 0x130 and 0x200, reset 0xFFFF.FFFF															
READ_ENABLE															
READ_ENABLE															

31	30	29	28	27	26	25	24	23	22	21	20	19	18	17	16
15	14	13	12	11	10	9	8	7	6	5	4	3	2	1	0
FMPPE0, type R/W, offset 0x134 and 0x400, reset 0xFFFF.FFFF															
PROG_ENABLE															
PROG_ENABLE															
USER_DBG, type R/W, offset 0x1D0, reset 0xFFFF.FFFE															
NW				DATA											
DATA												DBG1		DBG0	
USER_REG0, type R/W, offset 0x1E0, reset 0xFFFF.FFFF															
NW				DATA											
DATA															
USER_REG1, type R/W, offset 0x1E4, reset 0xFFFF.FFFF															
NW				DATA											
DATA															
FMPRE1, type R/W, offset 0x204, reset 0xFFFF.FFFF															
READ_ENABLE															
READ_ENABLE															
FMPRE2, type R/W, offset 0x208, reset 0xFFFF.FFFF															
READ_ENABLE															
READ_ENABLE															
FMPRE3, type R/W, offset 0x20C, reset 0xFFFF.FFFF															
READ_ENABLE															
READ_ENABLE															
FMPPE1, type R/W, offset 0x404, reset 0xFFFF.FFFF															
PROG_ENABLE															
PROG_ENABLE															
FMPPE2, type R/W, offset 0x408, reset 0xFFFF.FFFF															
PROG_ENABLE															
PROG_ENABLE															
FMPPE3, type R/W, offset 0x40C, reset 0xFFFF.FFFF															
PROG_ENABLE															
PROG_ENABLE															
General-Purpose Input/Outputs (GPIOs)															
GPIO Port A base: 0x4000.4000															
GPIO Port B base: 0x4000.5000															
GPIO Port C base: 0x4000.6000															
GPIO Port D base: 0x4000.7000															
GPIO Port E base: 0x4002.4000															
GPIO Port F base: 0x4002.5000															
GPIO Port G base: 0x4002.6000															
GPIODATA, type R/W, offset 0x000, reset 0x0000.0000															
DATA															
GPIODIR, type R/W, offset 0x400, reset 0x0000.0000															
DIR															
GPIOIS, type R/W, offset 0x404, reset 0x0000.0000															
IS															
GPIOIBE, type R/W, offset 0x408, reset 0x0000.0000															
IBE															
GPIOIEV, type R/W, offset 0x40C, reset 0x0000.0000															
IEV															

31	30	29	28	27	26	25	24	23	22	21	20	19	18	17	16
15	14	13	12	11	10	9	8	7	6	5	4	3	2	1	0
GPIOIM, type R/W, offset 0x410, reset 0x0000.0000															
												IME			
GPIORIS, type RO, offset 0x414, reset 0x0000.0000															
												RIS			
GPIOMIS, type RO, offset 0x418, reset 0x0000.0000															
												MIS			
GPIOICR, type W1C, offset 0x41C, reset 0x0000.0000															
												IC			
GPIOAFSEL, type R/W, offset 0x420, reset -															
												AFSEL			
GPIODR2R, type R/W, offset 0x500, reset 0x0000.00FF															
												DRV2			
GPIODR4R, type R/W, offset 0x504, reset 0x0000.0000															
												DRV4			
GPIODR8R, type R/W, offset 0x508, reset 0x0000.0000															
												DRV8			
GPIODR, type R/W, offset 0x50C, reset 0x0000.0000															
												ODE			
GPIOPUR, type R/W, offset 0x510, reset -															
												PUE			
GPIOPDR, type R/W, offset 0x514, reset 0x0000.0000															
												PDE			
GPIOSLR, type R/W, offset 0x518, reset 0x0000.0000															
												SRL			
GPIODEN, type R/W, offset 0x51C, reset -															
												DEN			
GPIOLOCK, type R/W, offset 0x520, reset 0x0000.0001															
												LOCK			
												LOCK			
GPIOCR, type -, offset 0x524, reset -															
												CR			
GPIOPeriphID4, type RO, offset 0xFD0, reset 0x0000.0000															
												PID4			
GPIOPeriphID5, type RO, offset 0xFD4, reset 0x0000.0000															
												PID5			

31	30	29	28	27	26	25	24	23	22	21	20	19	18	17	16						
15	14	13	12	11	10	9	8	7	6	5	4	3	2	1	0						
GPIOPeriphID6, type RO, offset 0xFD8, reset 0x0000.0000																					
												PID6									
GPIOPeriphID7, type RO, offset 0xFDC, reset 0x0000.0000																					
												PID7									
GPIOPeriphID0, type RO, offset 0xFE0, reset 0x0000.0061																					
												PID0									
GPIOPeriphID1, type RO, offset 0xFE4, reset 0x0000.0000																					
												PID1									
GPIOPeriphID2, type RO, offset 0xFE8, reset 0x0000.0018																					
												PID2									
GPIOPeriphID3, type RO, offset 0xFEC, reset 0x0000.0001																					
												PID3									
GPIOCellID0, type RO, offset 0xFF0, reset 0x0000.000D																					
												CID0									
GPIOCellID1, type RO, offset 0xFF4, reset 0x0000.00F0																					
												CID1									
GPIOCellID2, type RO, offset 0xFF8, reset 0x0000.0005																					
												CID2									
GPIOCellID3, type RO, offset 0xFFC, reset 0x0000.00B1																					
												CID3									
General-Purpose Timers																					
Timer0 base: 0x4003.0000																					
Timer1 base: 0x4003.1000																					
Timer2 base: 0x4003.2000																					
Timer3 base: 0x4003.3000																					
GPTMCFG, type R/W, offset 0x000, reset 0x0000.0000																					
												GPTMCFG									
GPTMTAMR, type R/W, offset 0x004, reset 0x0000.0000																					
												TAAMS	TACMR	TAMR							
GPTMTBMR, type R/W, offset 0x008, reset 0x0000.0000																					
												TBAMS	TBCMR	TBMR							
GPTMCTL, type R/W, offset 0x00C, reset 0x0000.0000																					
TBPWML		TBOTE		TBEVENT		TBSTALL		TBEN		TAPWML		TAOTE		RTCEN		TAEVENT		TASTALL		TAEN	
GPTMIMR, type R/W, offset 0x018, reset 0x0000.0000																					
						CBEIM		CBMIM		TBTOIM				RTCIM		CAEIM		CAMIM		TATOIM	
GPTMRIS, type RO, offset 0x01C, reset 0x0000.0000																					
						CBERIS		CBMRIS		TBTORIS				RTCRIIS		CAERIS		CAMRIS		TATORIS	

31	30	29	28	27	26	25	24	23	22	21	20	19	18	17	16					
15	14	13	12	11	10	9	8	7	6	5	4	3	2	1	0					
GPTMMIS, type RO, offset 0x020, reset 0x0000.0000																				
								CBEMIS		CBMMIS		TBTOMIS				RTCMIS		CAEMIS	CMMIS	TATOMIS
GPTMICR, type W1C, offset 0x024, reset 0x0000.0000																				
								CBECINT		CBMCINT		TBTOCINT				RTCCINT		CAECINT	CAMCINT	TATOCINT
GPTMTAILR, type R/W, offset 0x028, reset 0x0000.FFFF (16-bit mode) and 0xFFFF.FFFF (32-bit mode)																				
TAILRH																				
TAILRL																				
GPTMTBILR, type R/W, offset 0x02C, reset 0x0000.FFFF																				
TBILRL																				
GPTMTAMATCHR, type R/W, offset 0x030, reset 0x0000.FFFF (16-bit mode) and 0xFFFF.FFFF (32-bit mode)																				
TAMRH																				
TAMRL																				
GPTMTBMATCHR, type R/W, offset 0x034, reset 0x0000.FFFF																				
TBMRL																				
GPTMTAPR, type R/W, offset 0x038, reset 0x0000.0000																				
TAPSR																				
GPTMTBPR, type R/W, offset 0x03C, reset 0x0000.0000																				
TBPSR																				
GPTMTAPMR, type R/W, offset 0x040, reset 0x0000.0000																				
TAPSMR																				
GPTMTBPMR, type R/W, offset 0x044, reset 0x0000.0000																				
TBPSMR																				
GPTMTAR, type RO, offset 0x048, reset 0x0000.FFFF (16-bit mode) and 0xFFFF.FFFF (32-bit mode)																				
TARH																				
TARL																				
GPTMTBR, type RO, offset 0x04C, reset 0x0000.FFFF																				
TBRL																				
Watchdog Timer																				
Base 0x4000.0000																				
WDTLOAD, type R/W, offset 0x000, reset 0xFFFF.FFFF																				
WDTLoad																				
WDTLoad																				
WDTVALUE, type RO, offset 0x004, reset 0xFFFF.FFFF																				
WDTValue																				
WDTValue																				
WDTCTL, type R/W, offset 0x008, reset 0x0000.0000																				
														RESEN	INTEN					
WDTICR, type WO, offset 0x00C, reset -																				
WDTIntClr																				
WDTIntClr																				
WDTRIS, type RO, offset 0x010, reset 0x0000.0000																				
WDTRIS																				

31	30	29	28	27	26	25	24	23	22	21	20	19	18	17	16
15	14	13	12	11	10	9	8	7	6	5	4	3	2	1	0
WDTMIS, type RO, offset 0x014, reset 0x0000.0000															
															WDTMIS
WDTTST, type R/W, offset 0x418, reset 0x0000.0000															
															STALL
WDTLOCK, type R/W, offset 0xC00, reset 0x0000.0000															
WDTLock															
WDTLock															
WDTPeriphID4, type RO, offset 0xFD0, reset 0x0000.0000															
															PID4
WDTPeriphID5, type RO, offset 0xFD4, reset 0x0000.0000															
															PID5
WDTPeriphID6, type RO, offset 0xFD8, reset 0x0000.0000															
															PID6
WDTPeriphID7, type RO, offset 0xFDC, reset 0x0000.0000															
															PID7
WDTPeriphID0, type RO, offset 0xFE0, reset 0x0000.0005															
															PID0
WDTPeriphID1, type RO, offset 0xFE4, reset 0x0000.0018															
															PID1
WDTPeriphID2, type RO, offset 0xFE8, reset 0x0000.0018															
															PID2
WDTPeriphID3, type RO, offset 0xFEC, reset 0x0000.0001															
															PID3
WDTPCellID0, type RO, offset 0xFF0, reset 0x0000.000D															
															CID0
WDTPCellID1, type RO, offset 0xFF4, reset 0x0000.00F0															
															CID1
WDTPCellID2, type RO, offset 0xFF8, reset 0x0000.0005															
															CID2
WDTPCellID3, type RO, offset 0xFFC, reset 0x0000.00B1															
															CID3
Analog-to-Digital Converter (ADC)															
Base 0x4003.8000															
ADCACTSS, type R/W, offset 0x000, reset 0x0000.0000															
												ASEN3	ASEN2	ASEN1	ASEN0
ADCRIS, type RO, offset 0x004, reset 0x0000.0000															
												INR3	INR2	INR1	INR0

31	30	29	28	27	26	25	24	23	22	21	20	19	18	17	16		
15	14	13	12	11	10	9	8	7	6	5	4	3	2	1	0		
ADCIM, type R/W, offset 0x008, reset 0x0000.0000																	
												MASK3	MASK2	MASK1	MASK0		
ADCISC, type R/W1C, offset 0x00C, reset 0x0000.0000																	
												IN3	IN2	IN1	IN0		
ADCSTAT, type R/W1C, offset 0x010, reset 0x0000.0000																	
												OV3	OV2	OV1	OV0		
ADCEMUX, type R/W, offset 0x014, reset 0x0000.0000																	
EM3				EM2				EM1				EM0					
ADCUSTAT, type R/W1C, offset 0x018, reset 0x0000.0000																	
												UV3	UV2	UV1	UV0		
ADCSSPRI, type R/W, offset 0x020, reset 0x0000.3210																	
SS3				SS2				SS1				SS0					
ADCPSSI, type WO, offset 0x028, reset -																	
												SS3	SS2	SS1	SS0		
ADCSAC, type R/W, offset 0x030, reset 0x0000.0000																	
												AVG					
ADCSSMUX0, type R/W, offset 0x040, reset 0x0000.0000																	
MUX7				MUX6				MUX5				MUX4					
MUX3				MUX2				MUX1				MUX0					
ADCSSCTL0, type R/W, offset 0x044, reset 0x0000.0000																	
IE7			END7			D7			IE6			END6			D6		
IE3			END3			D3			IE2			END2			D2		
									IE5			END5			D5		
									IE1			END1			D1		
ADCSSFIFO0, type RO, offset 0x048, reset 0x0000.0000																	
												DATA					
ADCSSFIFO1, type RO, offset 0x068, reset 0x0000.0000																	
												DATA					
ADCSSFIFO2, type RO, offset 0x088, reset 0x0000.0000																	
												DATA					
ADCSSFIFO3, type RO, offset 0x0A8, reset 0x0000.0000																	
												DATA					
ADCSSFSTAT0, type RO, offset 0x04C, reset 0x0000.0100																	
FULL				EMPTY				HPTR				TPTR					
ADCSSFSTAT1, type RO, offset 0x06C, reset 0x0000.0100																	
FULL				EMPTY				HPTR				TPTR					
ADCSSFSTAT2, type RO, offset 0x08C, reset 0x0000.0100																	
FULL				EMPTY				HPTR				TPTR					

31	30	29	28	27	26	25	24	23	22	21	20	19	18	17	16																				
15	14	13	12	11	10	9	8	7	6	5	4	3	2	1	0																				
ADCSSFSTAT3, type RO, offset 0x0AC, reset 0x0000.0100																																			
FULL				EMPTY				HPTR				TPTR																							
ADCSSMUX1, type RO, offset 0x060, reset 0x0000.0000																																			
MUX3				MUX2				MUX1				MUX0																							
ADCSSMUX2, type RO, offset 0x080, reset 0x0000.0000																																			
MUX3				MUX2				MUX1				MUX0																							
ADCSSCTL1, type RO, offset 0x064, reset 0x0000.0000																																			
IE3			END3			D3			IE2			END2			D2			IE1			END1			D1			IE0			END0			D0		
ADCSSCTL2, type RO, offset 0x084, reset 0x0000.0000																																			
IE3			END3			D3			IE2			END2			D2			IE1			END1			D1			IE0			END0			D0		
ADCSSMUX3, type R/W, offset 0x0A0, reset 0x0000.0000																																			
												MUX0																							
ADCSSCTL3, type R/W, offset 0x0A4, reset 0x0000.0002																																			
												IE0			END0			D0																	
ADCTMLB, type RO, offset 0x100, reset 0x0000.0000																																			
						CNT				CONT		DIFF		MUX																					
ADCTMLB, type WO, offset 0x100, reset 0x0000.0000																																			
															LB																				
Universal Asynchronous Receivers/Transmitters (UARTs)																																			
UART0 base: 0x4000.C000																																			
UART1 base: 0x4000.D000																																			
UART2 base: 0x4000.E000																																			
UARTDR, type R/W, offset 0x000, reset 0x0000.0000																																			
				OE				BE				PE				FE				DATA															
UARTSR/UARTECR, type RO, offset 0x004, reset 0x0000.0000																																			
												OE				BE				PE				FE											
UARTSR/UARTECR, type WO, offset 0x004, reset 0x0000.0000																																			
												DATA																							
UARTFR, type RO, offset 0x018, reset 0x0000.0090																																			
						TXFE		RXFF		TXFF		RXFE		BUSY																					
UARTILPR, type R/W, offset 0x020, reset 0x0000.0000																																			
												ILPDVSR																							
UARTIBRD, type R/W, offset 0x024, reset 0x0000.0000																																			
												DIVINT																							
UARTFBRD, type R/W, offset 0x028, reset 0x0000.0000																																			
												DIVFRAC																							

31	30	29	28	27	26	25	24	23	22	21	20	19	18	17	16
15	14	13	12	11	10	9	8	7	6	5	4	3	2	1	0
UARTLCRH, type R/W, offset 0x02C, reset 0x0000.0000															
								SPS	WLEN		FEN	STP2	EPS	PEN	BRK
UARTCTL, type R/W, offset 0x030, reset 0x0000.0300															
						RXE	TXE	LBE					SIRLP	SIREN	UARTEN
UARTFLS, type R/W, offset 0x034, reset 0x0000.0012															
										RXIFLSEL			TXIFLSEL		
UARTIM, type R/W, offset 0x038, reset 0x0000.0000															
				OEIM	BEIM	PEIM	FEIM	RTIM	TXIM	RXIM					
UARTRIS, type RO, offset 0x03C, reset 0x0000.000F															
				OERIS	BERIS	PERIS	FERIS	RTRIS	TXRIS	RXRIS					
UARTMIS, type RO, offset 0x040, reset 0x0000.0000															
				OEMIS	BEMIS	PEMIS	FEMIS	RTMIS	TXMIS	RXMIS					
UARTICR, type W1C, offset 0x044, reset 0x0000.0000															
				OEIC	BEIC	PEIC	FEIC	RTIC	TXIC	RXIC					
UARTPeriphID4, type RO, offset 0xFD0, reset 0x0000.0000															
										PID4					
UARTPeriphID5, type RO, offset 0xFD4, reset 0x0000.0000															
										PID5					
UARTPeriphID6, type RO, offset 0xFD8, reset 0x0000.0000															
										PID6					
UARTPeriphID7, type RO, offset 0xFDC, reset 0x0000.0000															
										PID7					
UARTPeriphID0, type RO, offset 0xFE0, reset 0x0000.0011															
										PID0					
UARTPeriphID1, type RO, offset 0xFE4, reset 0x0000.0000															
										PID1					
UARTPeriphID2, type RO, offset 0xFE8, reset 0x0000.0018															
										PID2					
UARTPeriphID3, type RO, offset 0xFEC, reset 0x0000.0001															
										PID3					
UARTPCellID0, type RO, offset 0xFF0, reset 0x0000.000D															
										CID0					
UARTPCellID1, type RO, offset 0xFF4, reset 0x0000.00F0															
										CID1					

31	30	29	28	27	26	25	24	23	22	21	20	19	18	17	16	
15	14	13	12	11	10	9	8	7	6	5	4	3	2	1	0	
UARTPCellID2, type RO, offset 0xFF8, reset 0x0000.0005																
CID2																
UARTPCellID3, type RO, offset 0xFFC, reset 0x0000.00B1																
CID3																
Synchronous Serial Interface (SSI)																
SSIO base: 0x4000.8000																
SSICR0, type R/W, offset 0x000, reset 0x0000.0000																
SCR								SPH	SPO	FRF	DSS					
SSICR1, type R/W, offset 0x004, reset 0x0000.0000																
												SOD	MS	SSE	LBM	
SSIDR, type R/W, offset 0x008, reset 0x0000.0000																
DATA																
SSISR, type RO, offset 0x00C, reset 0x0000.0003																
												BSY	RFF	RNE	TNF	TFE
SSICPSR, type R/W, offset 0x010, reset 0x0000.0000																
CPSDVSR																
SSIIM, type R/W, offset 0x014, reset 0x0000.0000																
												TXIM	RXIM	RTIM	RORIM	
SSIRIS, type RO, offset 0x018, reset 0x0000.0008																
												TXRIS	RXRIS	RTRIS	RORRIS	
SSIMIS, type RO, offset 0x01C, reset 0x0000.0000																
												TXMIS	RXMIS	RTMIS	RORMIS	
SSIIICR, type W1C, offset 0x020, reset 0x0000.0000																
														RTIC	RORIC	
SSIPeriphID4, type RO, offset 0xFD0, reset 0x0000.0000																
PID4																
SSIPeriphID5, type RO, offset 0xFD4, reset 0x0000.0000																
PID5																
SSIPeriphID6, type RO, offset 0xFD8, reset 0x0000.0000																
PID6																
SSIPeriphID7, type RO, offset 0xFDC, reset 0x0000.0000																
PID7																
SSIPeriphID0, type RO, offset 0xFE0, reset 0x0000.0022																
PID0																
SSIPeriphID1, type RO, offset 0xFE4, reset 0x0000.0000																
PID1																

31	30	29	28	27	26	25	24	23	22	21	20	19	18	17	16
15	14	13	12	11	10	9	8	7	6	5	4	3	2	1	0
SSIPeriphID2, type RO, offset 0xFE8, reset 0x0000.0018															
												PID2			
SSIPeriphID3, type RO, offset 0xFEC, reset 0x0000.0001															
												PID3			
SSIPCellID0, type RO, offset 0xFF0, reset 0x0000.000D															
												CID0			
SSIPCellID1, type RO, offset 0xFF4, reset 0x0000.00F0															
												CID1			
SSIPCellID2, type RO, offset 0xFF8, reset 0x0000.0005															
												CID2			
SSIPCellID3, type RO, offset 0xFFC, reset 0x0000.00B1															
												CID3			
Inter-Integrated Circuit (I²C) Interface															
I²C Master															
I2C Master 0 base: 0x4002.0000															
I2CMSA, type R/W, offset 0x000, reset 0x0000.0000															
												SA		R/S	
I2CMCS, type RO, offset 0x004, reset 0x0000.0000															
								BUSBSY	IDLE	ARBLST	DATAACK	ADRACK	ERROR	BUSY	
I2CMCS, type WO, offset 0x004, reset 0x0000.0000															
										ACK	STOP	START	RUN		
I2CMDR, type R/W, offset 0x008, reset 0x0000.0000															
												DATA			
I2CMTPR, type R/W, offset 0x00C, reset 0x0000.0001															
												TPR			
I2CMIMR, type R/W, offset 0x010, reset 0x0000.0000															
														IM	
I2CMRIS, type RO, offset 0x014, reset 0x0000.0000															
														RIS	
I2CMMIS, type RO, offset 0x018, reset 0x0000.0000															
														MIS	
I2CMICR, type WO, offset 0x01C, reset 0x0000.0000															
														IC	
I2CMCR, type R/W, offset 0x020, reset 0x0000.0000															
										SFE	MFE	LPBK			
Inter-Integrated Circuit (I²C) Interface															

31	30	29	28	27	26	25	24	23	22	21	20	19	18	17	16
15	14	13	12	11	10	9	8	7	6	5	4	3	2	1	0
I²C Slave															
I ² C Slave 0 base: 0x4002.0800															
I2CSOAR, type R/W, offset 0x000, reset 0x0000.0000															
												OAR			
I2CSCSR, type RO, offset 0x004, reset 0x0000.0000															
												FBR	TREQ	RREQ	
I2CSCSR, type WO, offset 0x004, reset 0x0000.0000															
															DA
I2CSDR, type R/W, offset 0x008, reset 0x0000.0000															
												DATA			
I2CSIMR, type R/W, offset 0x00C, reset 0x0000.0000															
															IM
I2CSRIS, type RO, offset 0x010, reset 0x0000.0000															
															RIS
I2CSMIS, type RO, offset 0x014, reset 0x0000.0000															
															MIS
I2CSICR, type WO, offset 0x018, reset 0x0000.0000															
															IC
Ethernet Controller															
Ethernet MAC															
Base 0x4004.8000															
MACRIS, type RO, offset 0x000, reset 0x0000.0000															
								PHYINT	MDINT	RXER	FOV	TXEMP	TXER	RXINT	
MACIACK, type W1C, offset 0x000, reset 0x0000.0000															
								PHYINT	MDINT	RXER	FOV	TXEMP	TXER	RXINT	
MACIM, type R/W, offset 0x004, reset 0x0000.007F															
								PHYINTM	MDINTM	RXERM	FOVM	TXEMPM	TXERM	RXINTM	
MACRCTL, type R/W, offset 0x008, reset 0x0000.0008															
										RSTFIFO	BADCRC	PRMS	AMUL	RXEN	
MACTCTL, type R/W, offset 0x00C, reset 0x0000.0000															
										DUPLEX	CRC	PADEN	TXEN		
MACDATA, type RO, offset 0x010, reset 0x0000.0000															
RXDATA															
RXDATA															
MACDATA, type WO, offset 0x010, reset 0x0000.0000															
TXDATA															
TXDATA															

31	30	29	28	27	26	25	24	23	22	21	20	19	18	17	16
15	14	13	12	11	10	9	8	7	6	5	4	3	2	1	0
MACIA0, type R/W, offset 0x014, reset 0x0000.0000															
MACOCT4								MACOCT3							
MACOCT2								MACOCT1							
MACIA1, type R/W, offset 0x018, reset 0x0000.0000															
MACOCT6								MACOCT5							
MACTHR, type R/W, offset 0x01C, reset 0x0000.003F															
THRESH															
MACMCTL, type R/W, offset 0x020, reset 0x0000.0000															
REGADR WRITE START															
MACMDV, type R/W, offset 0x024, reset 0x0000.0080															
DIV															
MACMTXD, type R/W, offset 0x02C, reset 0x0000.0000															
MDTX															
MACMRXD, type R/W, offset 0x030, reset 0x0000.0000															
MDRX															
MACNP, type RO, offset 0x034, reset 0x0000.0000															
NPR															
MACTR, type R/W, offset 0x038, reset 0x0000.0000															
NEWTX															
Ethernet Controller															
MII Management															
Base 0x4004.8000															
MR0, type R/W, address 0x00, reset 0x3100															
RESET	LOOPBK	SPEEDSL	ANEGEN	PWRDN	ISO	RANEG	DUPLEX	COLT							
MR1, type RO, address 0x01, reset 0x7849															
	100X_F	100X_H	10T_F	10T_H					MFPS	ANEGC	RFAULT	ANEGA	LINK	JAB	EXTD
MR2, type RO, address 0x02, reset 0x000E															
OUI[21:6]															
MR3, type RO, address 0x03, reset 0x7237															
OUI[5:0]								MN				RN			
MR4, type R/W, address 0x04, reset 0x01E1															
NP		RF					A3	A2	A1	A0					S[4:0]
MR5, type RO, address 0x05, reset 0x0000															
NP	ACK	RF													S[4:0]
MR6, type RO, address 0x06, reset 0x0000															
											PDF	LPNPA		PRX	LPANEGA
MR16, type R/W, address 0x10, reset 0x0140															
RPTR	INPOL		TXHIM	SQEI	NL10						APOL	RVSPOL		PCSBP	RXCC
MR17, type R/W, address 0x11, reset 0x0000															
JABBER_IE	RXER_IE	PRX_IE	PDF_IE	LPACK_IE	LSCHG_IE	RFAULT_IE	ANEGCOMP_IE	JABBER_INT	RXER_INT	PRX_INT	PDF_INT	LPACK_INT	LSCHG_INT	RFAULT_INT	ANEGCOMP_INT
MR18, type RO, address 0x12, reset 0x0000															
			ANEGF	DPLX	RATE	RXSD	RX_LOCK								
MR19, type R/W, address 0x13, reset 0x4000															
TXO[1:0]															

31	30	29	28	27	26	25	24	23	22	21	20	19	18	17	16														
15	14	13	12	11	10	9	8	7	6	5	4	3	2	1	0														
MR23, type R/W, address 0x17, reset 0x0010																													
								LED1[3:0]				LED0[3:0]																	
MR24, type R/W, address 0x18, reset 0x00C0																													
				PD_MODE		AUTO_SW		MDIX		MDIX_CM		MDIX_SD																	
Pulse Width Modulator (PWM)																													
Base 0x4002.8000																													
PWMCTL, type R/W, offset 0x000, reset 0x0000.0000																													
															GlobalSync0														
PWMSYNC, type R/W, offset 0x004, reset 0x0000.0000																													
															Sync0														
PWMENABLE, type R/W, offset 0x008, reset 0x0000.0000																													
														PWM1En	PWM0En														
PWMINVERT, type R/W, offset 0x00C, reset 0x0000.0000																													
														PWM1Inv	PWM0Inv														
PWMFAULT, type R/W, offset 0x010, reset 0x0000.0000																													
														Fault1	Fault0														
PWMINTEN, type R/W, offset 0x014, reset 0x0000.0000																													
															IntFault														
															IntPWM0														
PWMRIS, type RO, offset 0x018, reset 0x0000.0000																													
															IntFault														
															IntPWM0														
PWMISC, type R/W1C, offset 0x01C, reset 0x0000.0000																													
															IntFault														
															IntPWM0														
PWMSTATUS, type RO, offset 0x020, reset 0x0000.0000																													
															Fault														
PWM0CTL, type R/W, offset 0x040, reset 0x0000.0000																													
								CmpBUpd		CmpAUpd		LoadUpd		Debug		Mode		Enable											
PWM0INTEN, type R/W, offset 0x044, reset 0x0000.0000																													
				TrCmpBD		TrCmpBU		TrCmpAD		TrCmpAU		TrCntLoad		TrCntZero				IntCmpBD		IntCmpBU		IntCmpAD		IntCmpAU		IntCntLoad		IntCntZero	
PWM0RIS, type RO, offset 0x048, reset 0x0000.0000																													
								IntCmpBD		IntCmpBU		IntCmpAD		IntCmpAU		IntCntLoad		IntCntZero											
PWM0ISC, type R/W1C, offset 0x04C, reset 0x0000.0000																													
								IntCmpBD		IntCmpBU		IntCmpAD		IntCmpAU		IntCntLoad		IntCntZero											
PWM0LOAD, type R/W, offset 0x050, reset 0x0000.0000																													
															Load														
PWM0COUNT, type RO, offset 0x054, reset 0x0000.0000																													
															Count														

31	30	29	28	27	26	25	24	23	22	21	20	19	18	17	16												
15	14	13	12	11	10	9	8	7	6	5	4	3	2	1	0												
PWM0CMPA, type R/W, offset 0x058, reset 0x0000.0000																											
CompA																											
PWM0CMPB, type R/W, offset 0x05C, reset 0x0000.0000																											
CompB																											
PWM0GENA, type R/W, offset 0x060, reset 0x0000.0000																											
				ActCmpBD				ActCmpBU				ActCmpAD				ActCmpAU				ActLoad				ActZero			
PWM0GENB, type R/W, offset 0x064, reset 0x0000.0000																											
				ActCmpBD				ActCmpBU				ActCmpAD				ActCmpAU				ActLoad				ActZero			
PWM0DBCTL, type R/W, offset 0x068, reset 0x0000.0000																											
Enable																											
PWM0DBRISE, type R/W, offset 0x06C, reset 0x0000.0000																											
RiseDelay																											
PWM0DBFALL, type R/W, offset 0x070, reset 0x0000.0000																											
FallDelay																											

C Ordering and Contact Information

C.1 Ordering Information

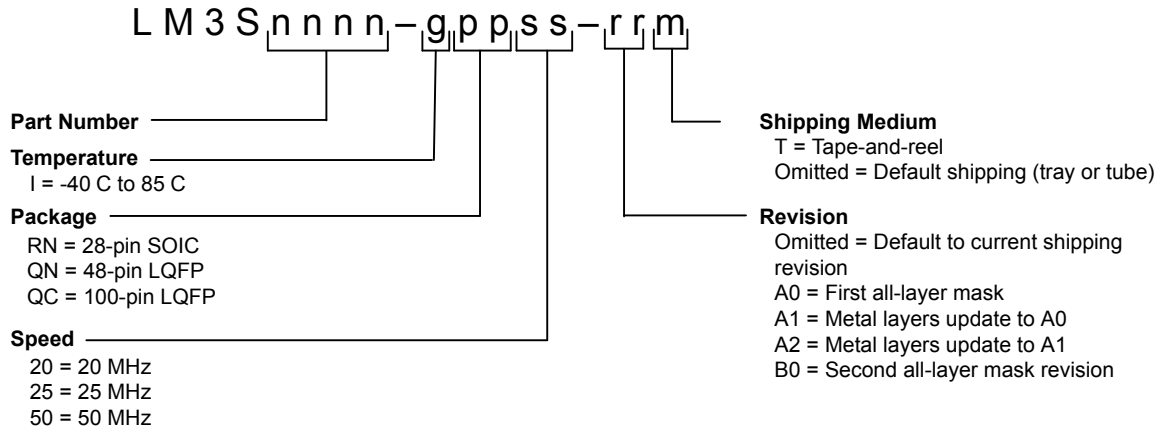

Table C-1. Part Ordering Information

Orderable Part Number	Description
LM3S6916-IQC50	Stellaris® LM3S6916 Microcontroller
LM3S6916-IQC50(T)	Stellaris® LM3S6916 Microcontroller

C.2 Kits

The Luminary Micro Stellaris® Family provides the hardware and software tools that engineers need to begin development quickly.

- Reference Design Kits accelerate product development by providing ready-to-run hardware, and comprehensive documentation including hardware design files:
http://www.luminarymicro.com/products/reference_design_kits/
- Evaluation Kits provide a low-cost and effective means of evaluating Stellaris® microcontrollers before purchase:
http://www.luminarymicro.com/products/evaluation_kits/
- Development Kits provide you with all the tools you need to develop and prototype embedded applications right out of the box:
<http://www.luminarymicro.com/products/boards.html>

See the Luminary Micro website for the latest tools available or ask your Luminary Micro distributor.

C.3 Company Information

Luminary Micro, Inc. designs, markets, and sells ARM Cortex-M3-based microcontrollers (MCUs). Austin, Texas-based Luminary Micro is the lead partner for the Cortex-M3 processor, delivering the world's first silicon implementation of the Cortex-M3 processor. Luminary Micro's introduction of the

Stellaris® family of products provides 32-bit performance for the same price as current 8- and 16-bit microcontroller designs. With entry-level pricing at \$1.00 for an ARM technology-based MCU, Luminary Micro's Stellaris product line allows for standardization that eliminates future architectural upgrades or software tool changes.

Luminary Micro, Inc.
108 Wild Basin, Suite 350
Austin, TX 78746
Main: +1-512-279-8800
Fax: +1-512-279-8879
<http://www.luminarymicro.com>
sales@luminarymicro.com

C.4 Support Information

For support on Luminary Micro products, contact:
support@luminarymicro.com +1-512-279-8800, ext. 3